

0202	TALBOT	ATE	X	76,8	56,9	16	4	2	170

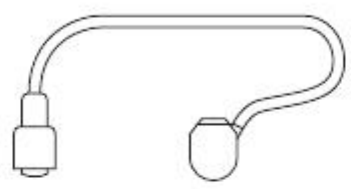

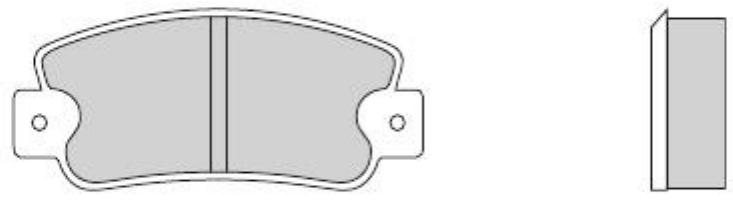

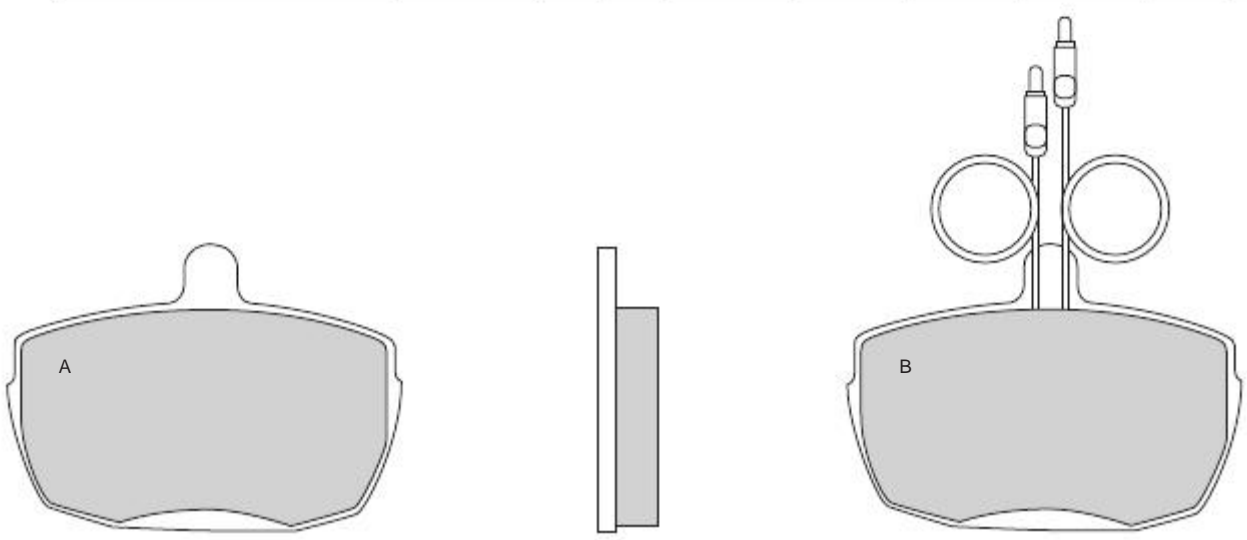







0203	AUTOBIANCHI - FIAT - SEAT	BENDIX	X	109	49	18	4		
-------------	---------------------------	--------	---	-----	----	----	---	--	--



0204	ALFA ROMEO - FIAT	LOCKHEED	X	104,8	74,7	18	2A-2B	2	140 220
-------------	-------------------	----------	---	-------	------	----	-------	---	------------



									
0205	FORD - HYUNDAI	GIRLING	X	78,4	66	15	2A-2B	2	225

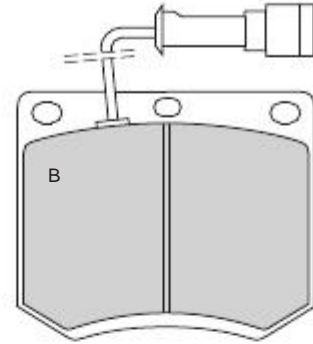
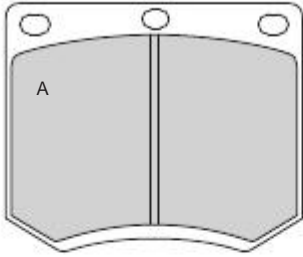



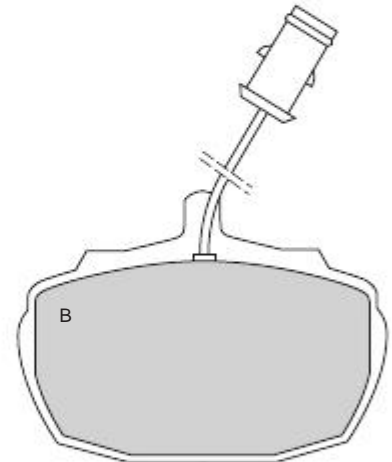
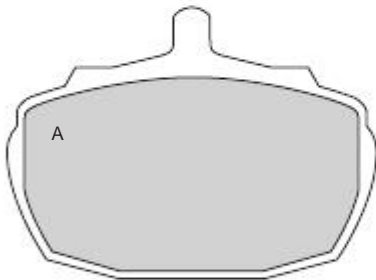



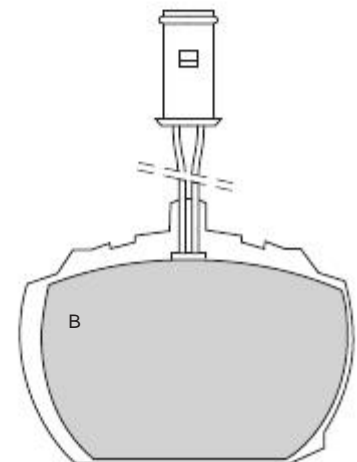
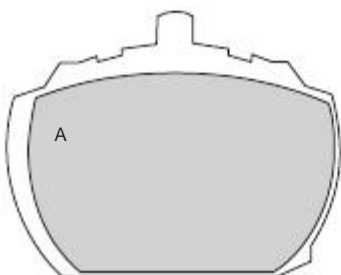

0206	ROVER	LOCKHEED	X	98,5	71	15	2A-2B	2	225
-------------	-------	----------	---	------	----	----	-------	---	-----



0207	ROVER - VAUXHALL	LOCKHEED	X	88,6	70,8	15	2A-2B	2	225
-------------	------------------	----------	---	------	------	----	-------	---	-----

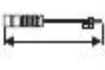

									
0208	FORD - SKODA	GIRLING	X	115	61	17,5	4		

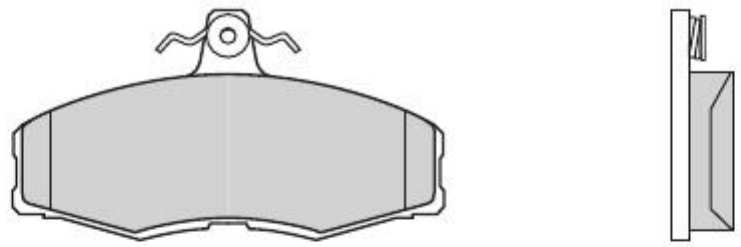



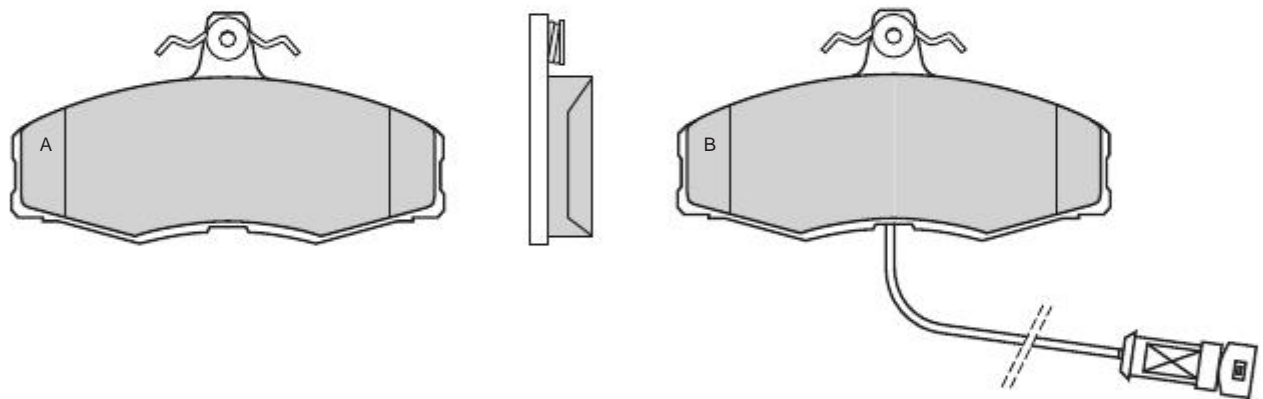



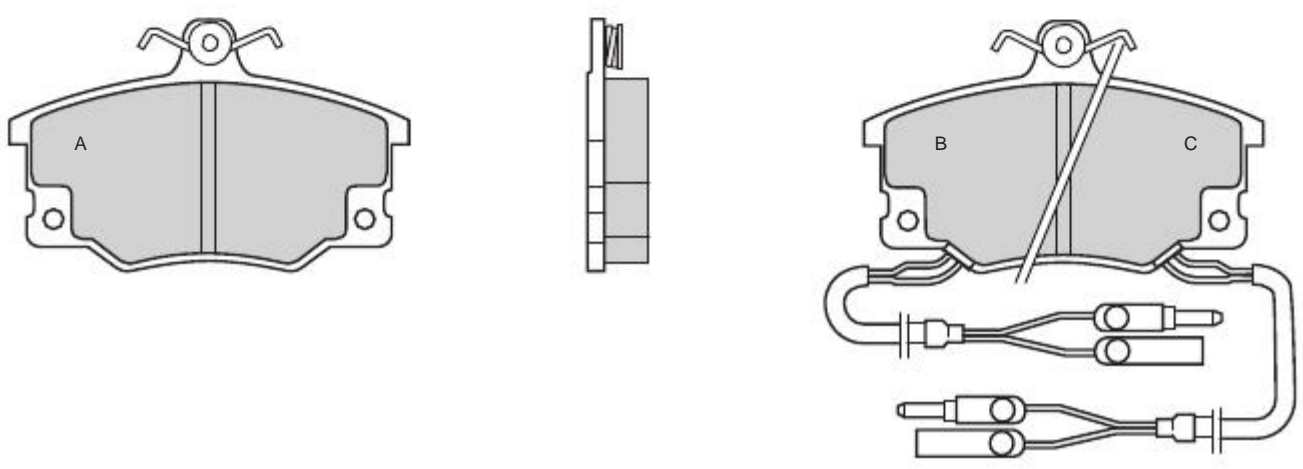



0209	FORD	GIRLING	X	115	61	17,5	2A-2B	2	225
-------------	------	---------	---	-----	----	------	-------	---	-----



0210	LANCIA	GIRLING	X	104,5	67	17,2	2A 1B-1C	2	700
-------------	--------	---------	---	-------	----	------	-------------	---	-----



									
0211	ALFA ROMEO	BENDIX	X	109	49	15	4		

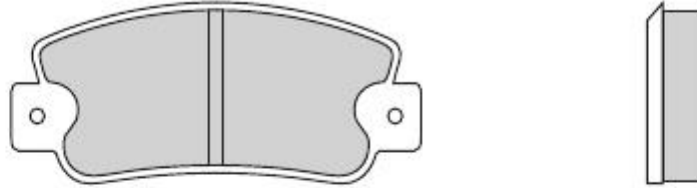



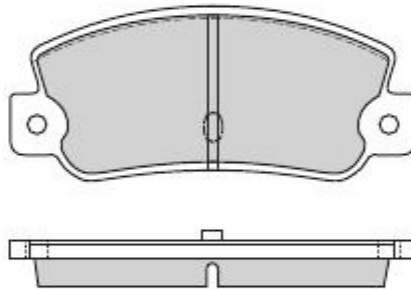



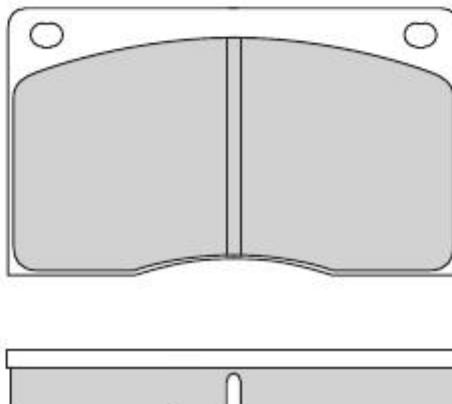

0212	FIAT - LANCIA	BENDIX	X	108,8	47	12	4		
-------------	---------------	--------	---	-------	----	----	---	--	--



0213	JAGUAR	GIRLING	X	119,6	71	15,5	4		
-------------	--------	---------	---	-------	----	------	---	--	--

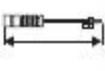

									
0214	CITROEN	CITROEN	X	54,9	60	12	4	4	110

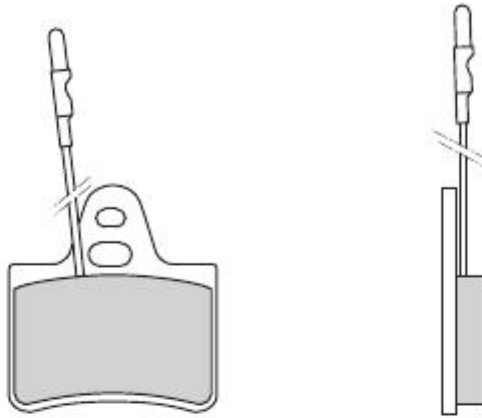



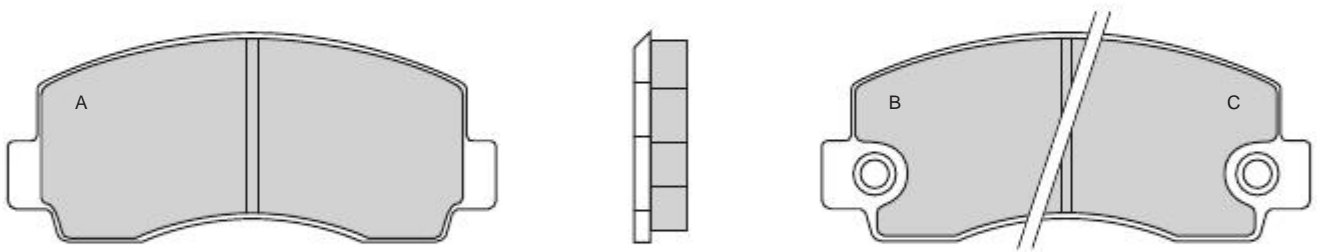



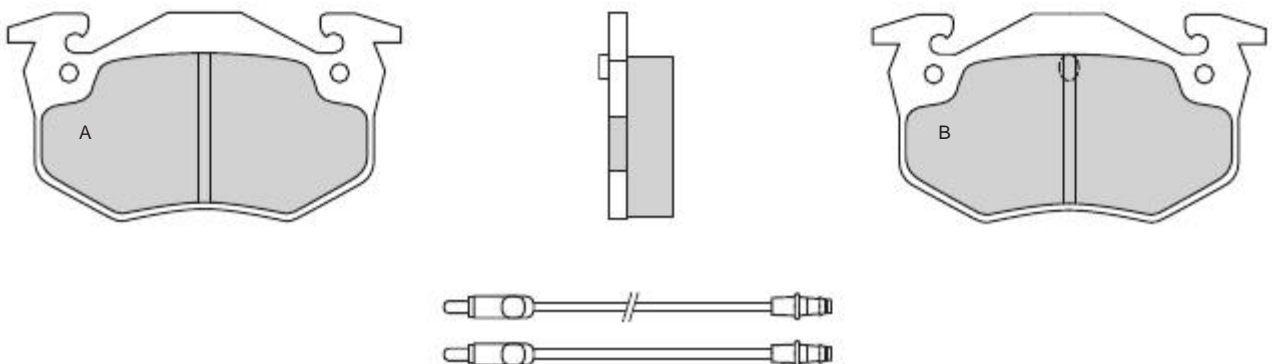



0215	TOYOTA	SUMITOMO	X	128,1	56,3	15,5	2A 1B-1C		
-------------	--------	----------	---	-------	------	------	-------------	--	--



0216	CITROEN - RENAULT	BENDIX	X	105	55	18	2A-2B	2 2	130 250
-------------	-------------------	--------	---	-----	----	----	-------	--------	------------



									
0217	PEUGEOT - RENAULT	BENDIX	X	105	55	11	4		

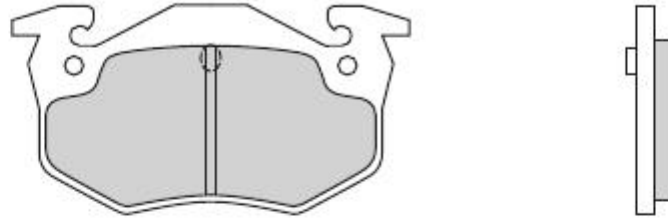



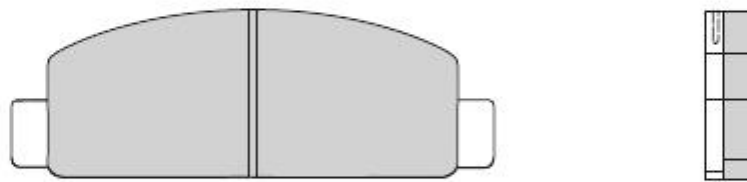



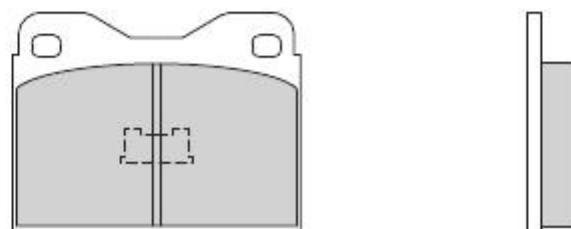



0218	MAZDA	AKEBONO	X	128	45,1	14	4		
-------------	-------	---------	---	-----	------	----	---	--	--



0219	PEUGEOT - RENAULT TALBOT	ATE	X	76,8	58,8	15	4		
-------------	-----------------------------	-----	---	------	------	----	---	--	--



									
0220	PEUGEOT - RENAULT TALBOT	BENDIX	X	108,9	46,2	15	4		

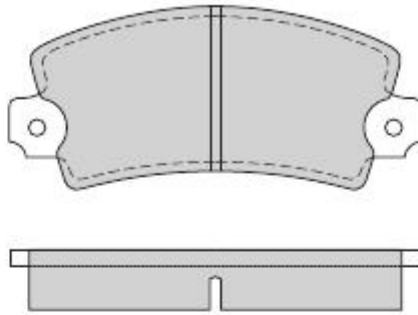

P1001 F3000



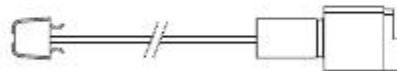
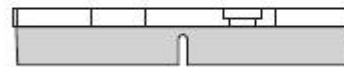
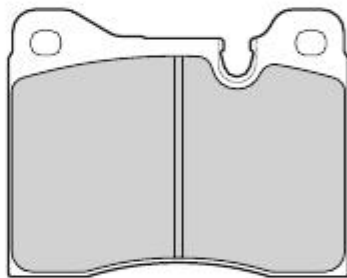





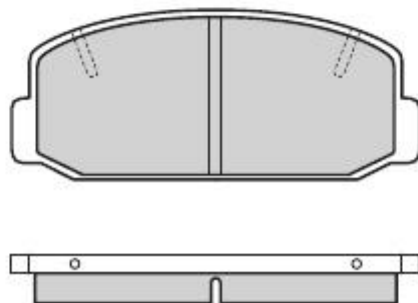

0221	ALFA ROMEO - BMW	ATE	X	89,7	70,6	15	4	2	130
-------------	-------------------------	------------	----------	-------------	-------------	-----------	----------	----------	------------



OPTIONAL

0223	DAIHATSU - TOYOTA	AKEBONO	X	108,1	45,6	14	4		
-------------	--------------------------	----------------	----------	--------------	-------------	-----------	----------	--	--



									
0224	ALFA ROMEO	ATE	X	61,8	56,5	15	3A-1B	1	800

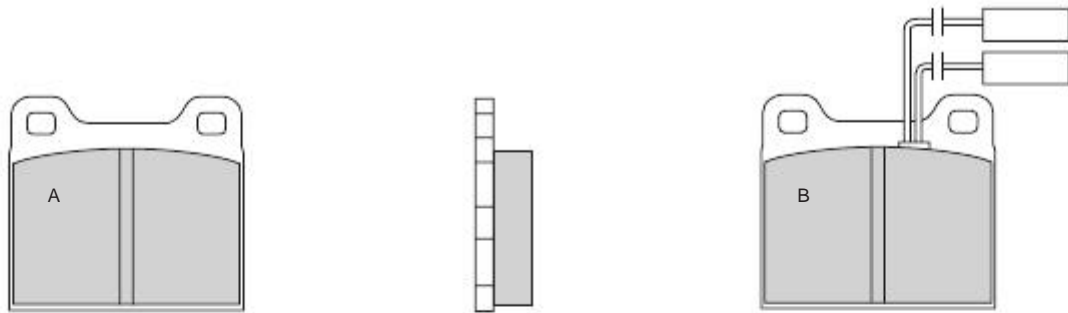



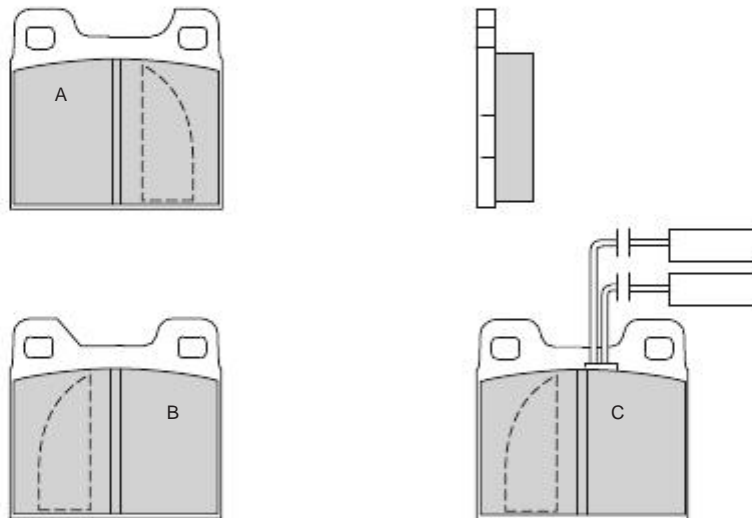



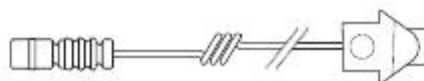
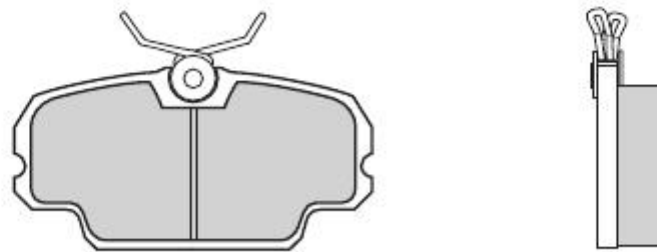

0225	ALFA ROMEO	ATE	X	55,8	53,5	15	2A 1B-1C	1	450
------	------------	-----	---	------	------	----	-------------	---	-----



0226	MERCEDES - SAAB	GIRLING	X	95	49,5	17,5	4	2	200
------	-----------------	---------	---	----	------	------	---	---	-----

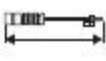

OPTIONAL

									
0227	MERCEDES	ATE	X	61,7	54,35	13	4		

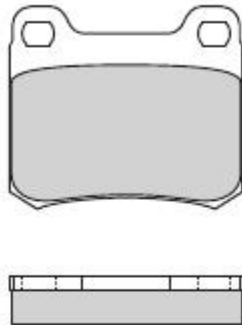



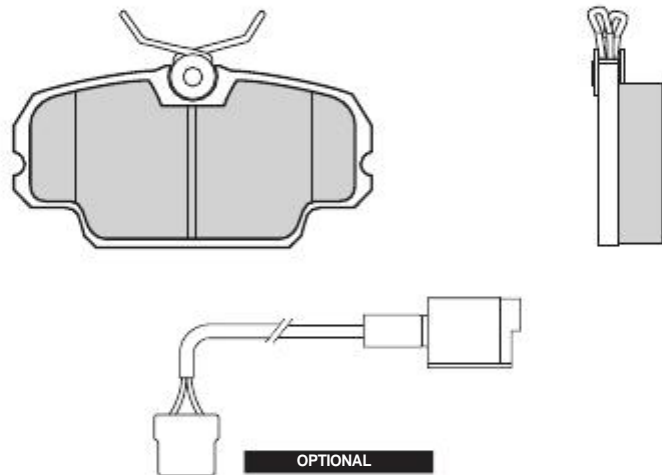



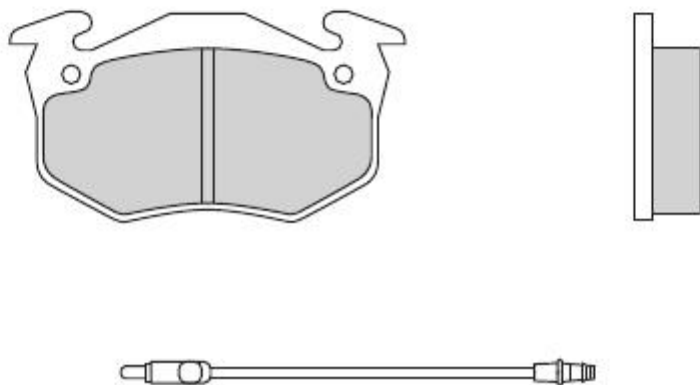



0228	BMW	GIRLING	X	95	49,5	16,5	4	2	240
------	-----	---------	---	----	------	------	---	---	-----



0229	PEUGEOT - RENAULT	BENDIX	X	105	55	18	4	2	130
------	-------------------	--------	---	-----	----	----	---	---	-----



									
0230	PEUGEOT - RENAULT	BENDIX	X	105	67	18	4	2	130

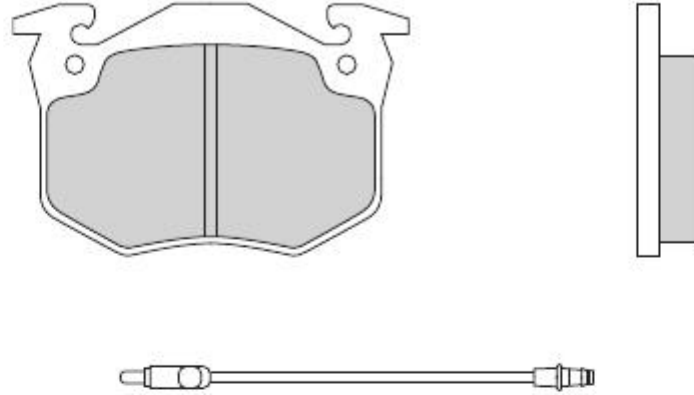



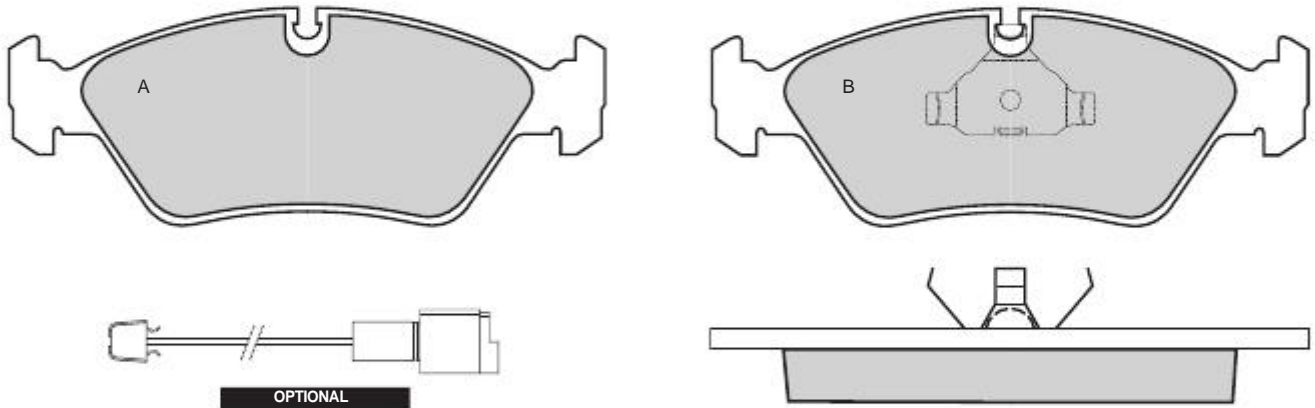



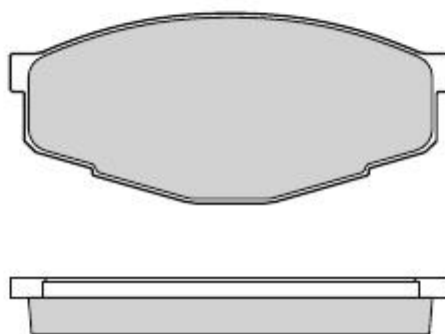



0231	BMW	ATE	X	158,4	58	19,5	2A-2B	2	260
-------------	-----	-----	---	-------	----	------	-------	---	-----



0232	NISSAN - TOYOTA	SUMITOMO	X	116,2	50,2	15	4		
-------------	-----------------	----------	---	-------	------	----	---	--	--



									
0233	MITSUBISHI	SUMITOMO	X	134,7	48,6	16	4		

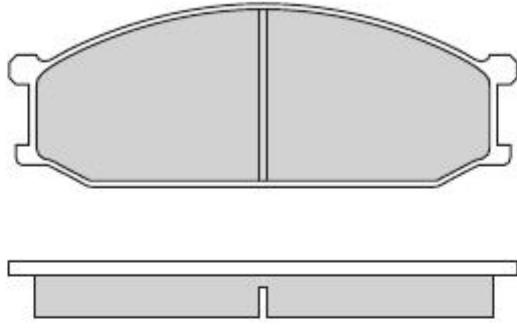



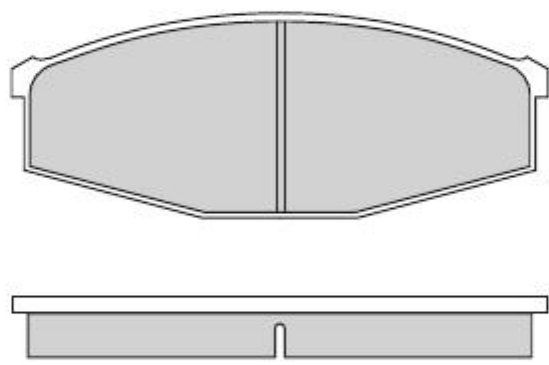



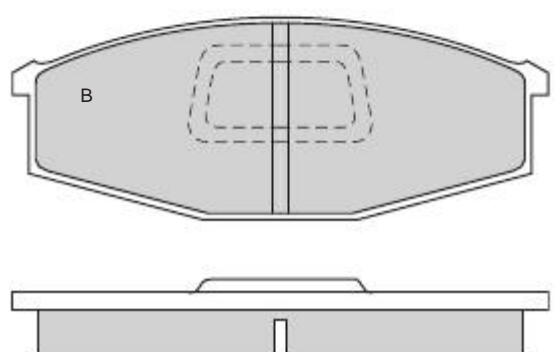
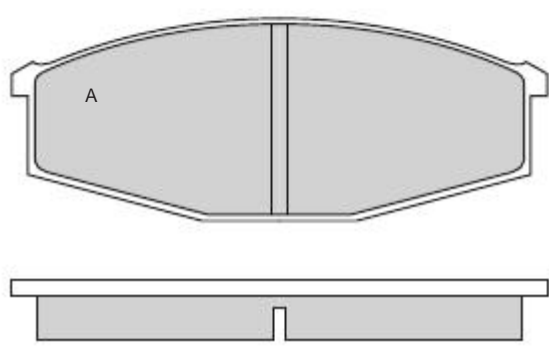

0234	NISSAN	SUMITOMO	X	142,2	53,4	17	4		
-------------	---------------	-----------------	----------	--------------	-------------	-----------	----------	--	--



0235	NISSAN	SUMITOMO	X	142,2	53,4	17	2A-2B		
-------------	---------------	-----------------	----------	--------------	-------------	-----------	--------------	--	--

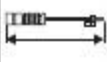

									
0236	BMW	ATE	X	125,1	36,5	17	2A-2B	2	160

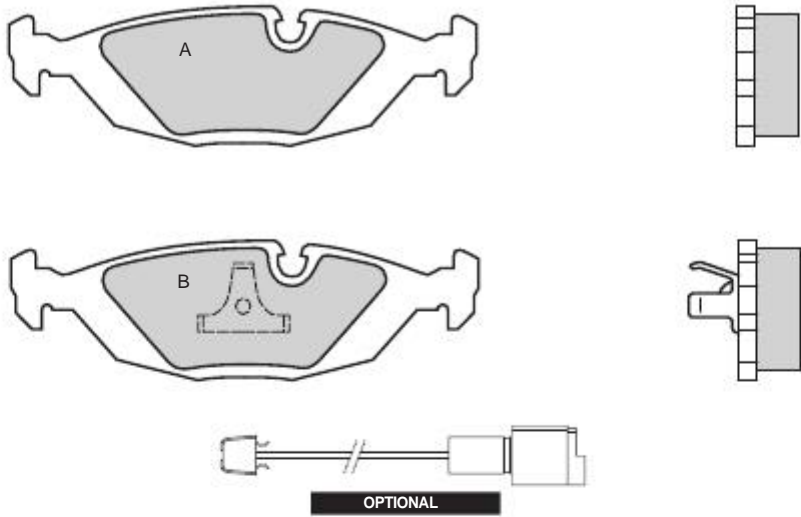



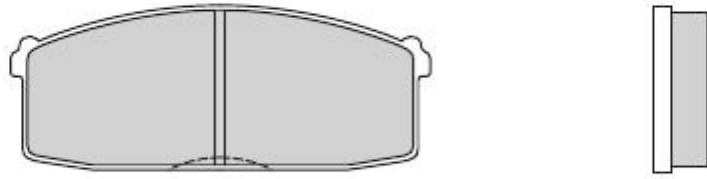



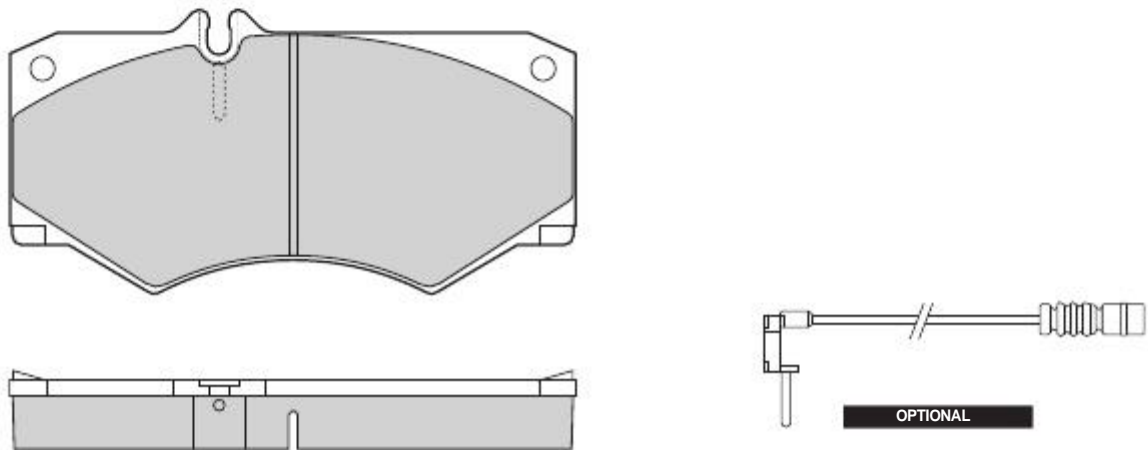

0237	NISSAN	AKEBONO	X	111,7	44	14,5	4		
------	--------	---------	---	-------	----	------	---	--	--



0238	MERCEDES - VOLKSWAGEN	PERROT	X	149	75	18	4	2	130
------	-----------------------	--------	---	-----	----	----	---	---	-----

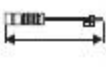

									
0239	TOYOTA	AKEBONO	X	A 132 B 120	51	15	2A-2B		

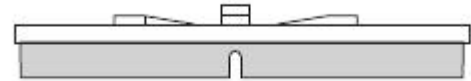
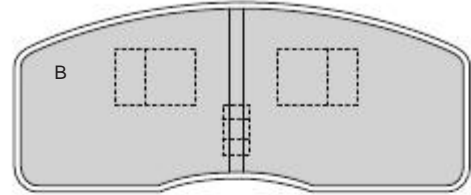
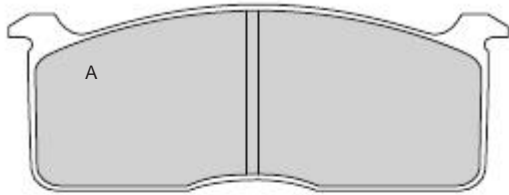



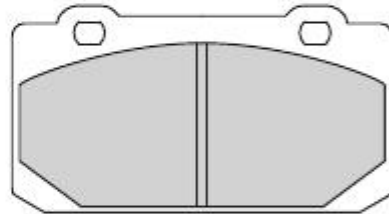



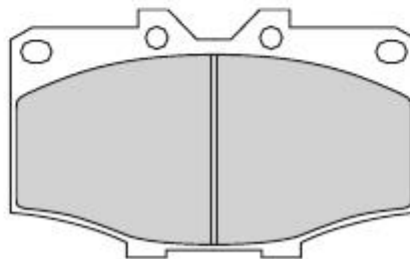



0240	ALFA ROMEO	ATE	X	100,05	54,9	15	4		
-------------	------------	-----	---	--------	------	----	---	--	--



0242	TOYOTA - VOLKSWAGEN	SUMITOMO	X	107,2	66	15,5	4		
-------------	---------------------	----------	---	-------	----	------	---	--	--



									
0244	HONDA	SUMITOMO	X	111,5	47,3	15,5	4		

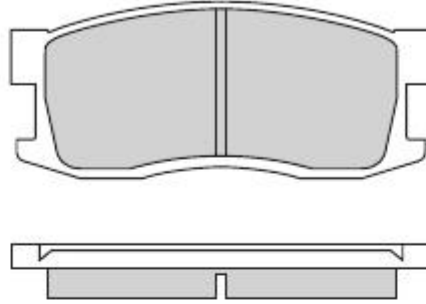



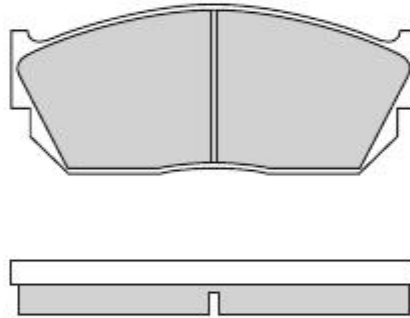



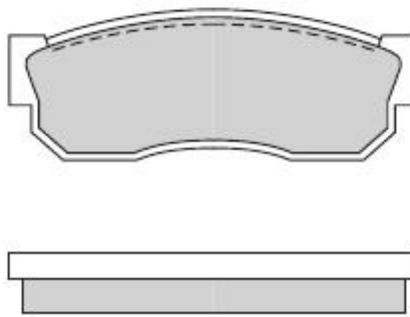



0245	HONDA	SUMITOMO	X	107	45	15	4		
-------------	-------	----------	---	-----	----	----	---	--	--



0246	NISSAN - SUBARU	SUMITOMO	X	108,5	40,2	16	4		
-------------	-----------------	----------	---	-------	------	----	---	--	--



									
0247	HONDA	AKEBONO	X	108	45	14,5	4		

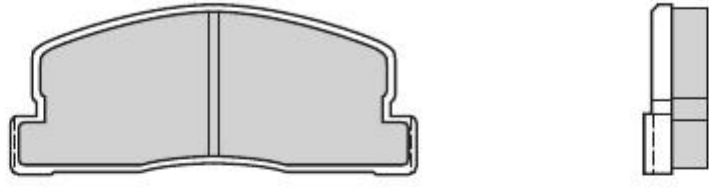



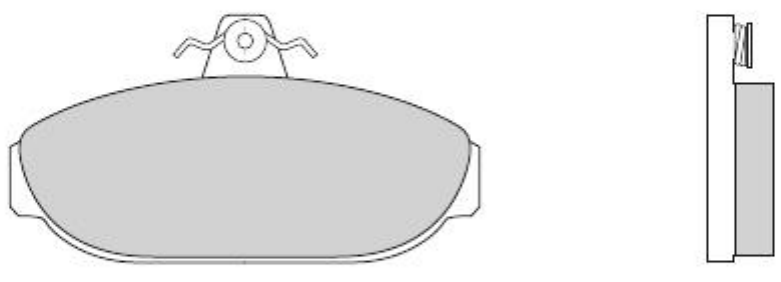



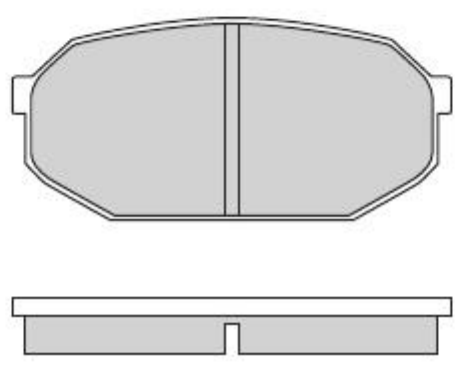



0248	VOLVO	GIRLING	X	125	65	17	4		
-------------	-------	---------	---	-----	----	----	---	--	--



0249	MITSUBISHI	SUMITOMO	X	116	54,5	15,5	4		
-------------	------------	----------	---	-----	------	------	---	--	--



									
0250	MAZDA	AKEBONO	X	A-B 156,4 C-D 154,7	61	15	1A-1B 1C-1D		

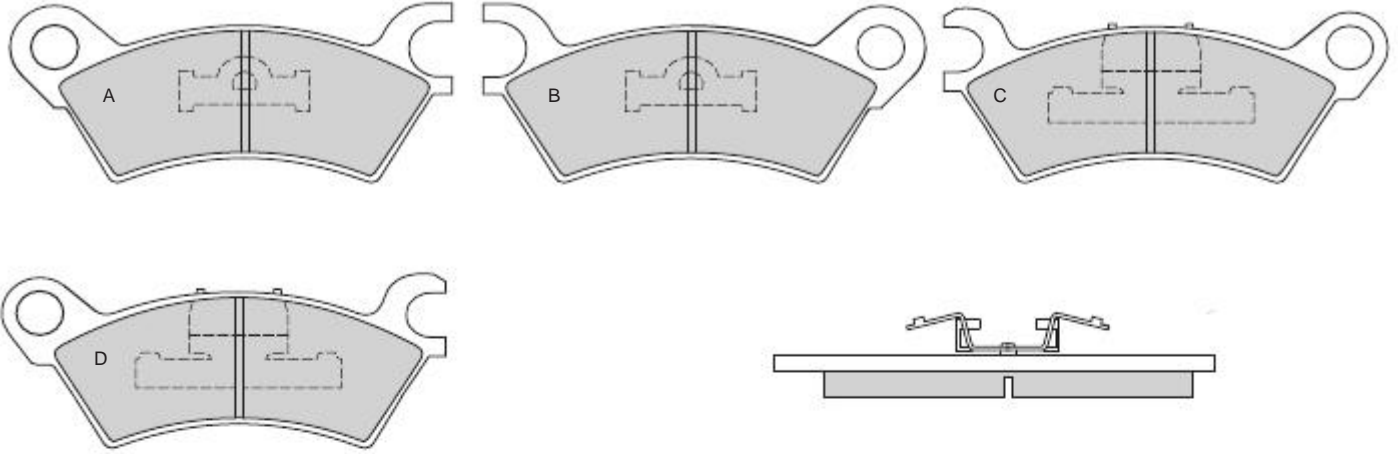



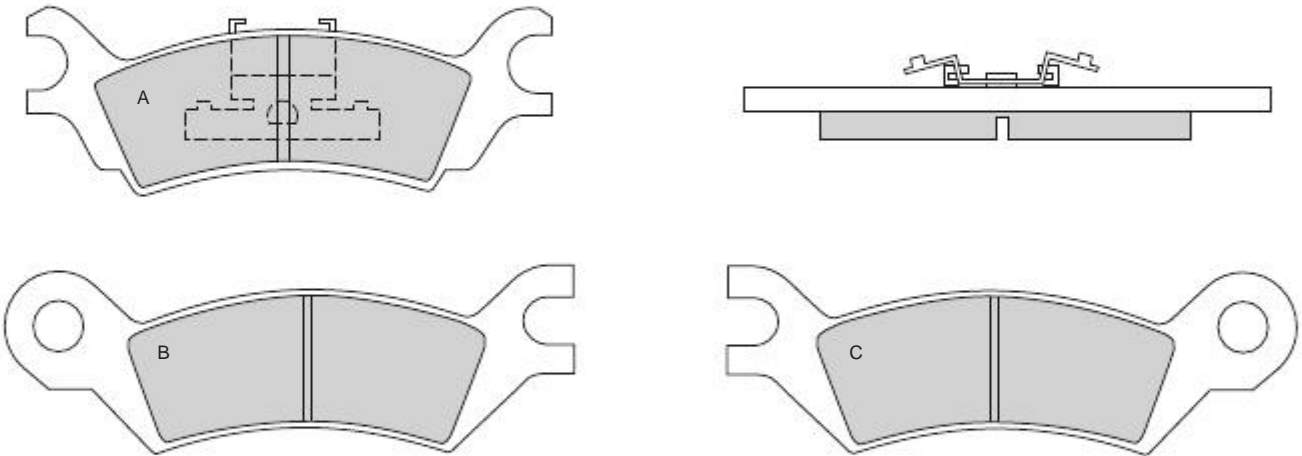



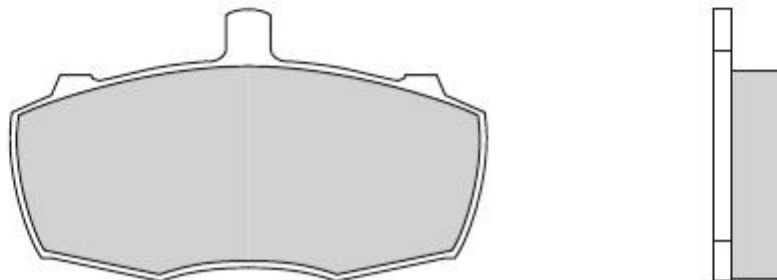

0251	MAZDA	AKEBONO	X	A 138,9 B-C 149,1	47	13	2A 1B-1C		
-------------	-------	---------	---	----------------------	----	----	-------------	--	--



0252	LAND ROVER	LOCKHEED	X	126,7	72,7	18	4		
-------------	------------	----------	---	-------	------	----	---	--	--

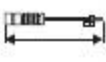

									
0253	MAZDA	AKEBONO	X	131,1	62,2	15	2A-2B		

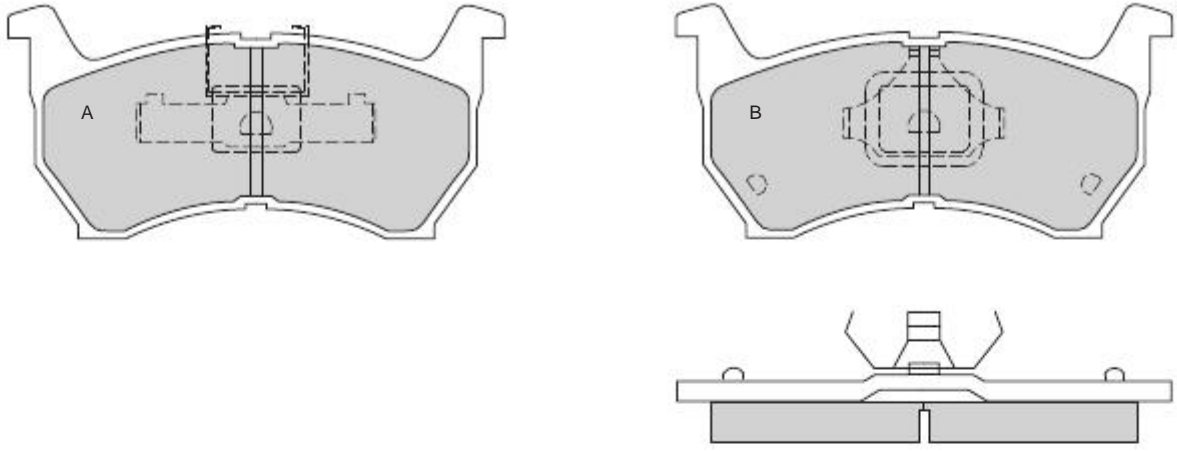



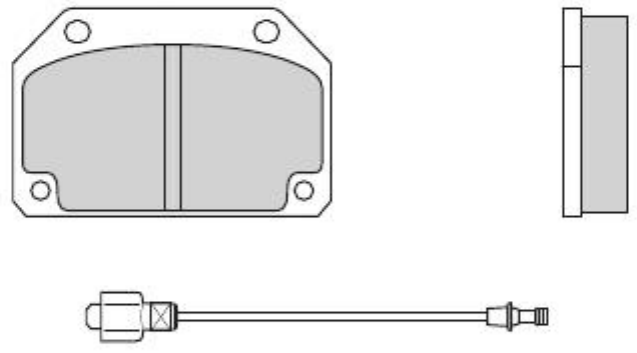



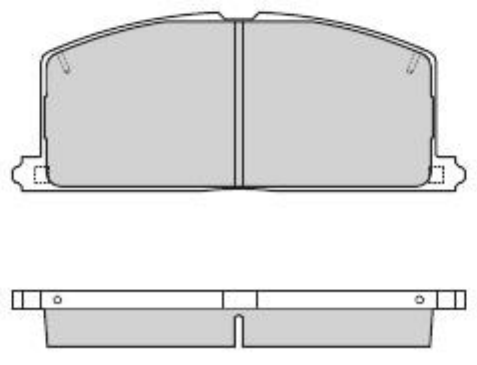



0254	TALBOT	BENDIX	X	84	55	17,2	4	2	110
-------------	--------	--------	---	----	----	------	---	---	-----



0255	TOYOTA	AKEBONO	X	120	47,5	15	4		
-------------	--------	---------	---	-----	------	----	---	--	--



OPTIONAL

									
0256	MITSUBISHI	AKEBONO	X	108	50	15	4		

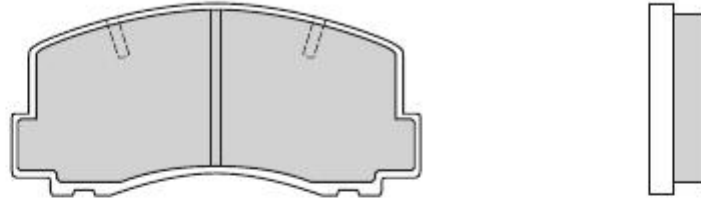



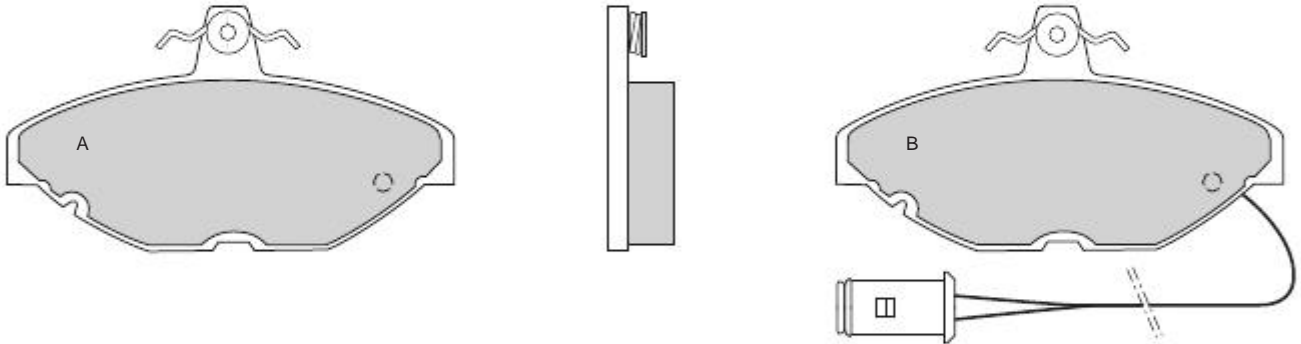



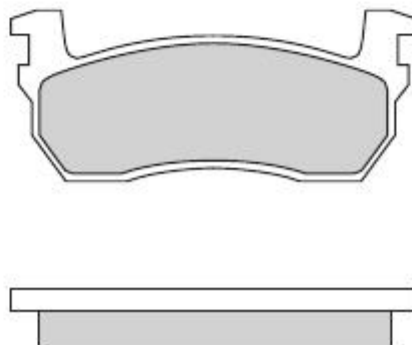

0258	ROVER	GIRLING	X	118,5	65	17	3A-1B	1	205
------	-------	---------	---	-------	----	----	-------	---	-----



0259	NISSAN	AKEBONO	X	108	45	16	4		
------	--------	---------	---	-----	----	----	---	--	--

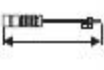

									
0260	VOLKSWAGEN	KELSEY-HAYES	X	137,6	A 51,1 B 48,8	15,3	2A-2B		

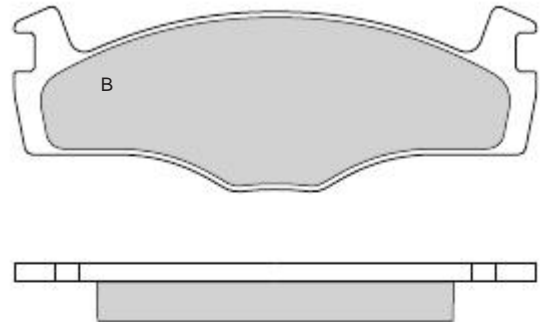
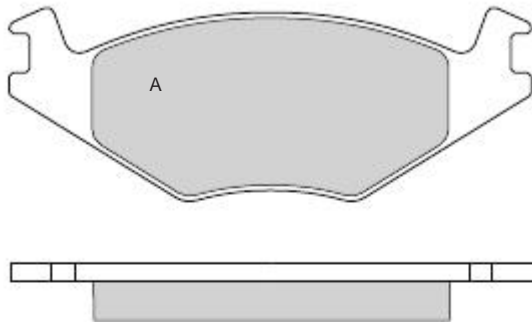



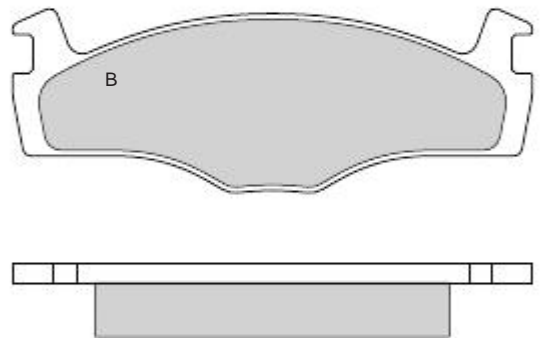
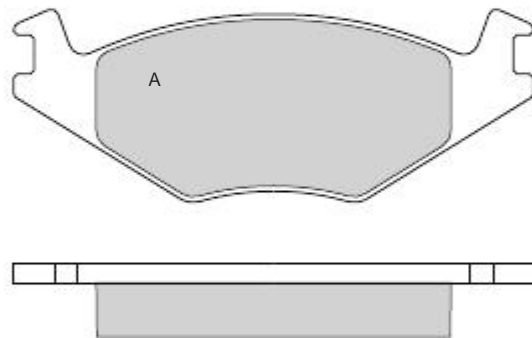



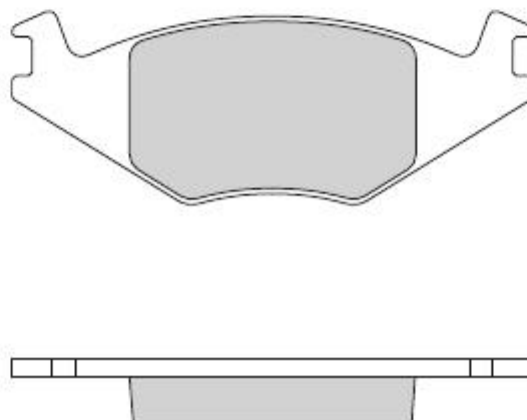



0261	VOLKSWAGEN	KELSEY-HAYES	X	137,6	A 51,1 B 48,8	19,3	2A-2B		
-------------	------------	--------------	---	-------	------------------	------	-------	--	--



0262	SEAT - VOLKSWAGEN	KELSEY-HAYES	X	137,6	51,1	17,3	4		
-------------	-------------------	--------------	---	-------	------	------	---	--	--



									
0263	FORD	ATE	X	141,3	44	17,5	2A-2B		

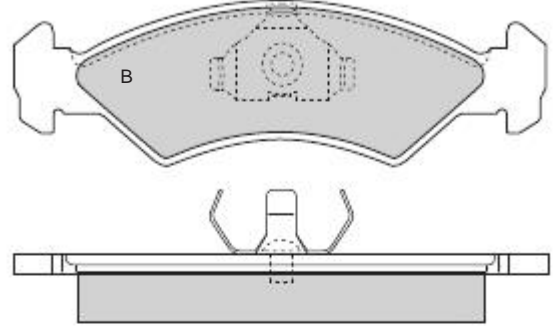
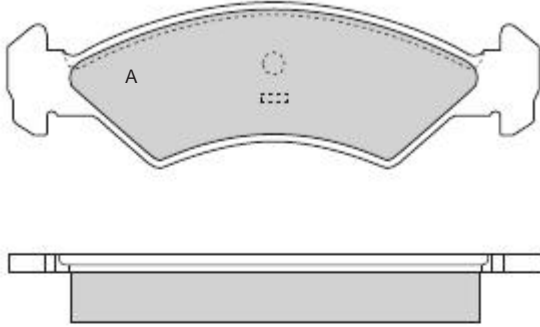



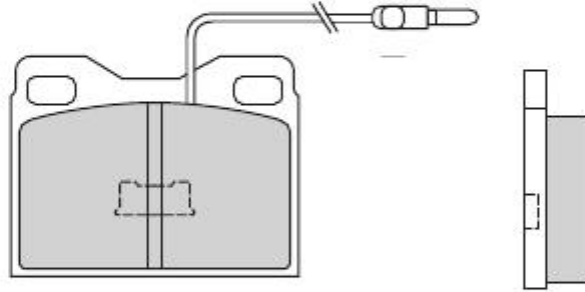



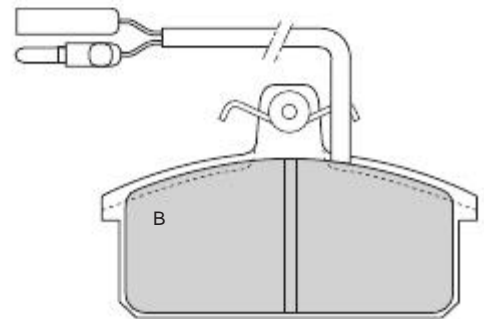
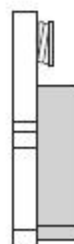
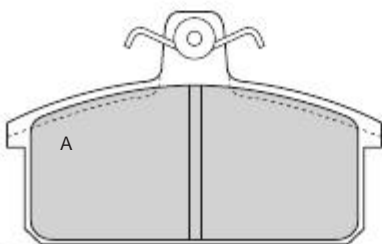

0264	PEUGEOT	ATE	X	76,5	58,7	16,5	4	4	250
-------------	---------	-----	---	------	------	------	---	---	-----



0265	LANCIA	GIRLING	X	99	61,5	16,5	2A-2B	2	700
-------------	--------	---------	---	----	------	------	-------	---	-----

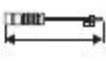

										
0265-1	SEAT	GIRLING	X		99	61,5	16,5	2A-2B	2	215

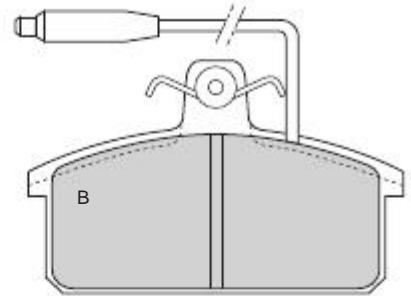
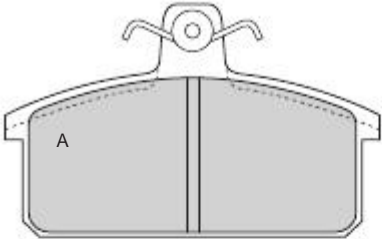



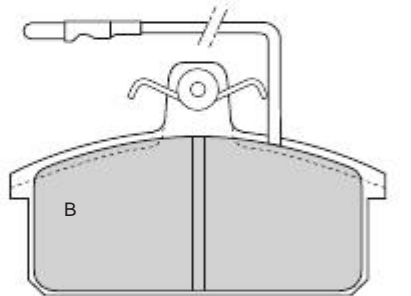
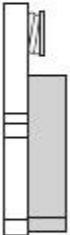
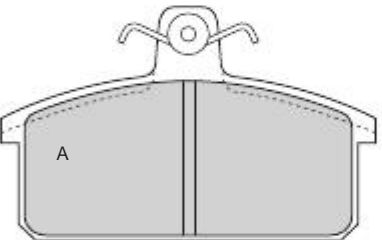



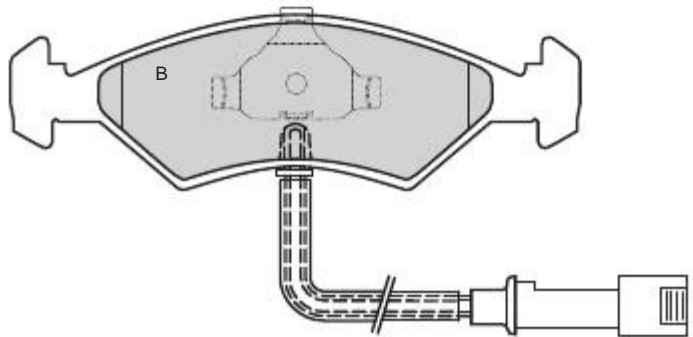
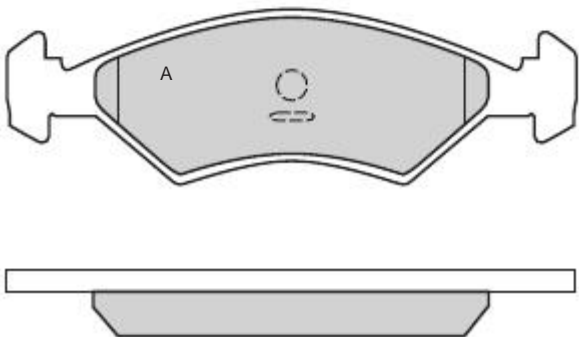



0265-2	LANCIA	GIRLING	X		99	61,5	16,5	2A-2B	2	240
---------------	--------	---------	---	--	----	------	------	-------	---	-----



0266	FORD	ATE	X		151,3	46,6	17,5	2A-2B	2	255
-------------	------	-----	---	--	-------	------	------	-------	---	-----



									
0267	VOLVO	BENDIX	X	113,9	51	17	4		

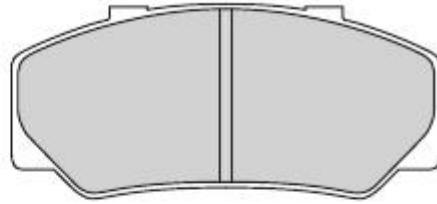



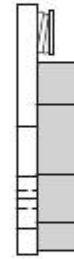
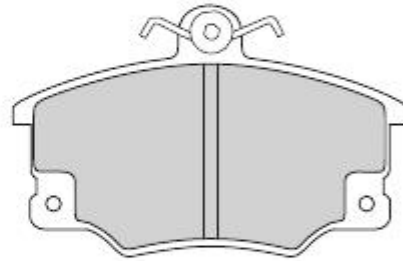



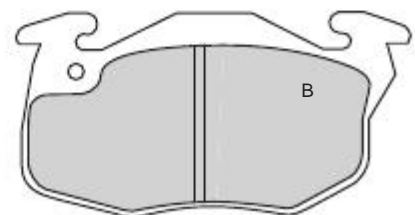
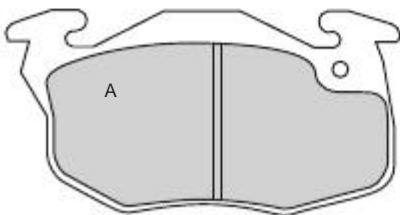



0268	ALFA ROMEO AUTOBIANCHI - FIAT - LANCIA	GIRLING	X	104,5	67	17	4		
-------------	---	----------------	----------	--------------	-----------	-----------	----------	--	--



0269	RENAULT - PEUGEOT	BENDIX	X	105	55	18	2A-2B	2	200
-------------	--------------------------	---------------	----------	------------	-----------	-----------	--------------	----------	------------



									
0270	MITSUBISHI - PROTON	SUMITOMO	X	111	49	15	4		

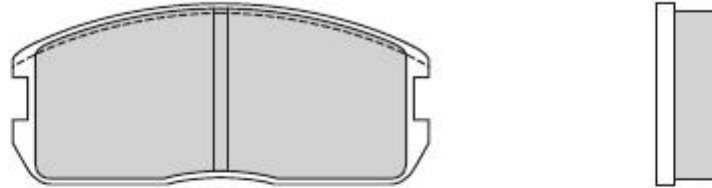



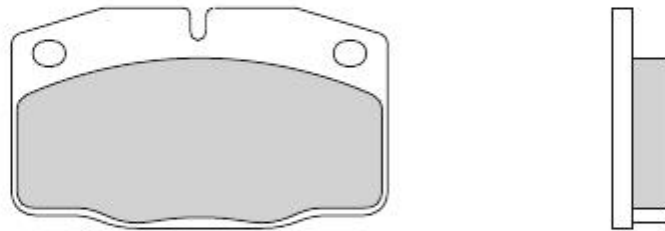



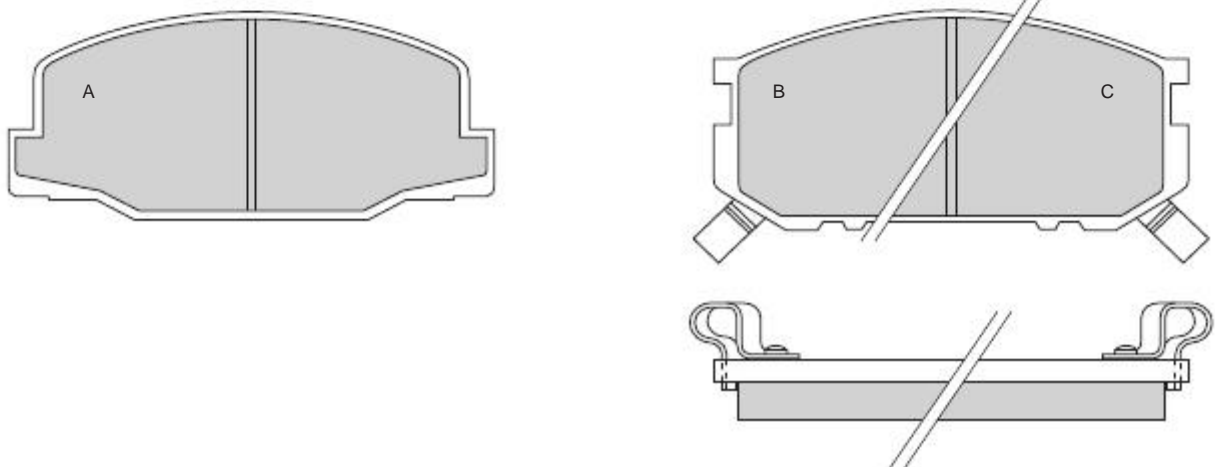



0271	OPEL - VAUXHALL	DELCO	X	100	59	15,5	4		
------	-----------------	-------	---	-----	----	------	---	--	--



0272	TOYOTA	AKEBONO	X	A 128,5 B 127	A 55 B 57	16	2A 1B-1C		
------	--------	---------	---	------------------	--------------	----	-------------	--	--



									
0273	NISSAN - DATSUN	SUMITOMO	X	130	51	15,5	2A 1B-1C		

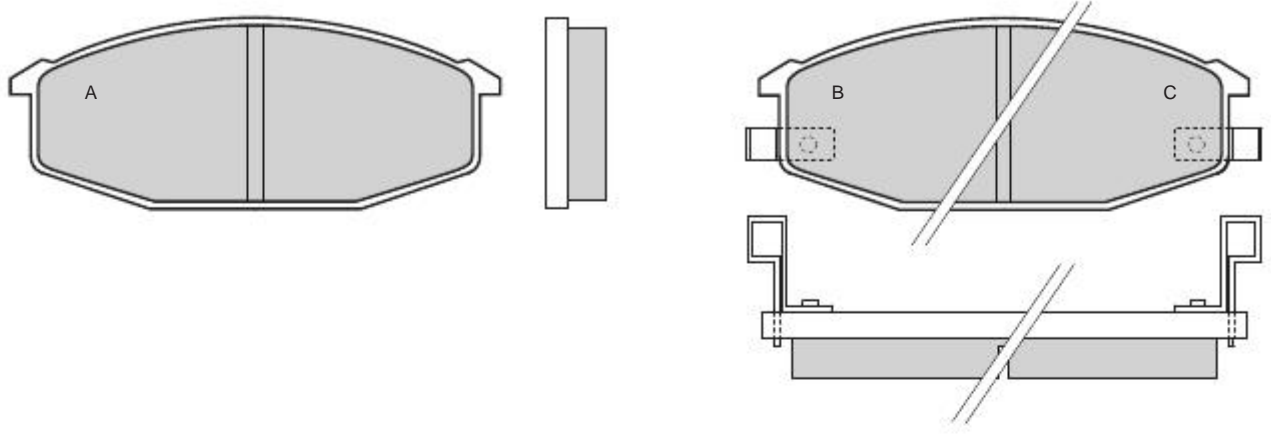



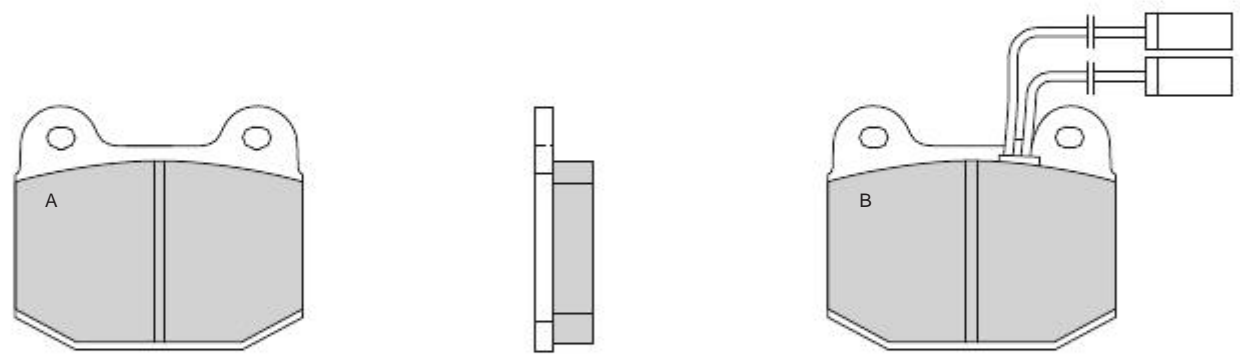



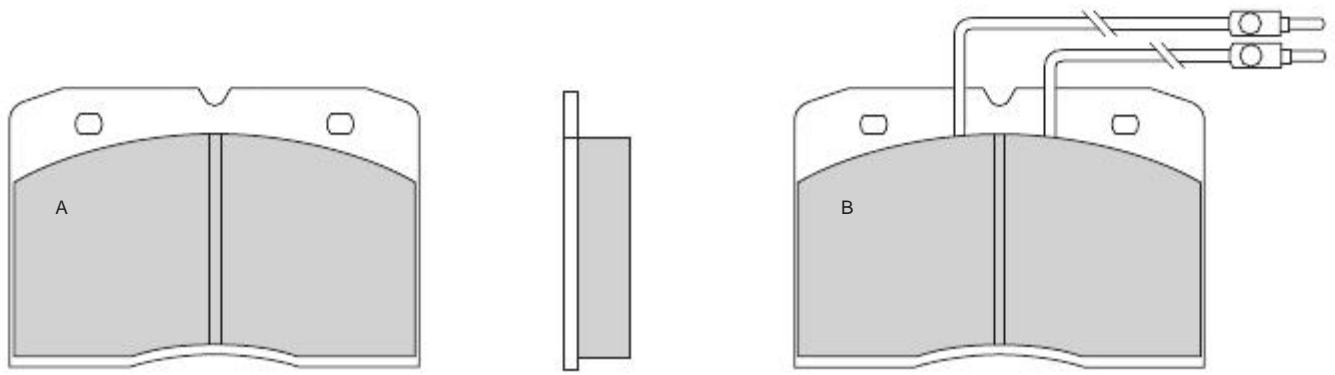



0274	ALFA ROMEO	ATE	X	76,5	65,2	16	2A-2B	2	800
------	------------	-----	---	------	------	----	-------	---	-----



0275	ALFA ROMEO - IVECO RENAULT	BREMBO	X	109,7	75	18	2A-2B	2	140 200
------	-------------------------------	--------	---	-------	----	----	-------	---	------------



									
0276	PEUGEOT	GIRLING	X	90	63	17,7	2A-2B	2	220

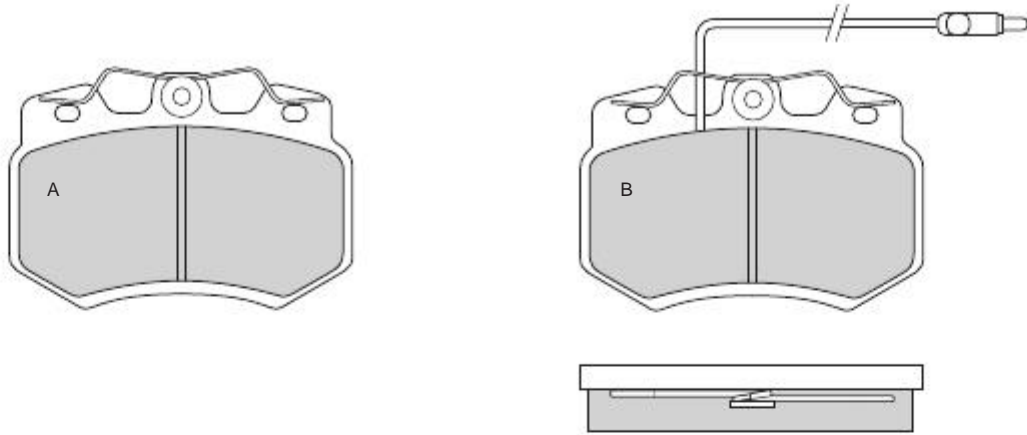



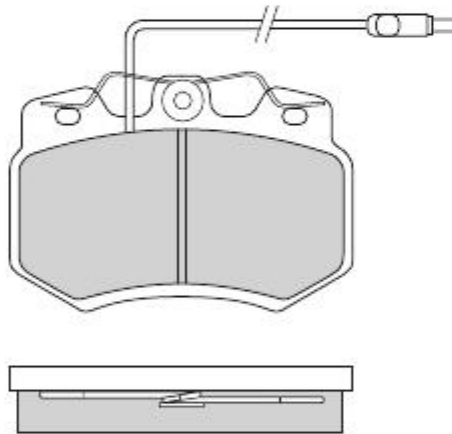



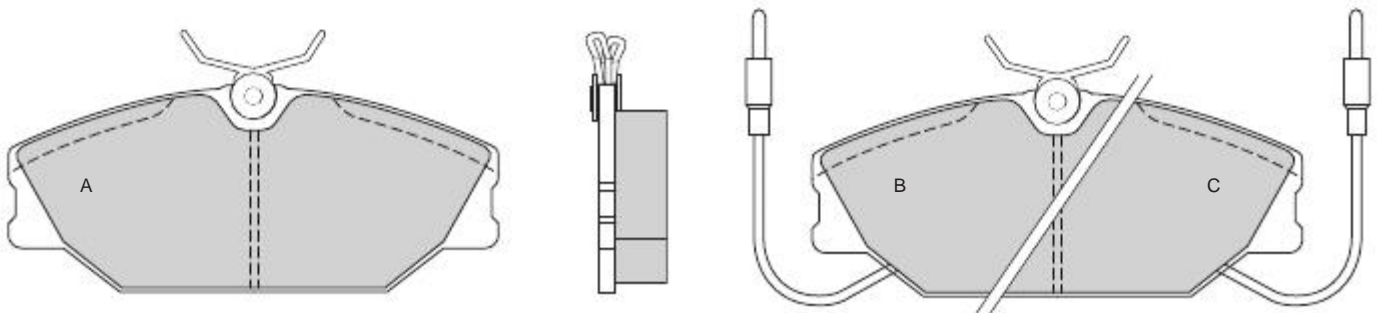

0276-1	CITROEN - PEUGEOT	GIRLING	X	90	63	17,7	4	4	220
---------------	-------------------	---------	---	----	----	------	---	---	-----



0277	RENAULT	GIRLING	X	130,1	55,8	18,5	2A 1 B - 1C	2	220
-------------	---------	---------	---	-------	------	------	----------------	---	-----

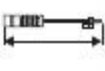

									
0278	SUZUKI	SUMITOMO	X	111	41,5	15,5	4		

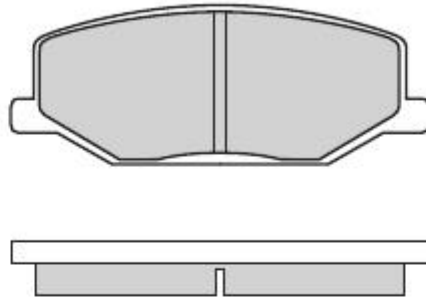



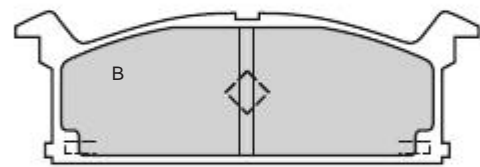
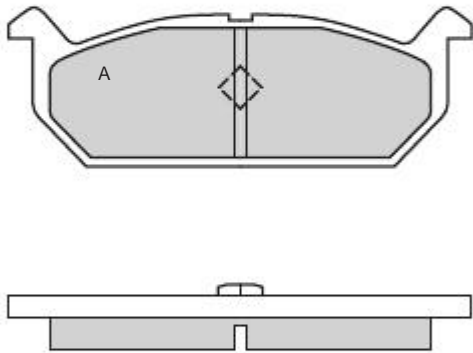



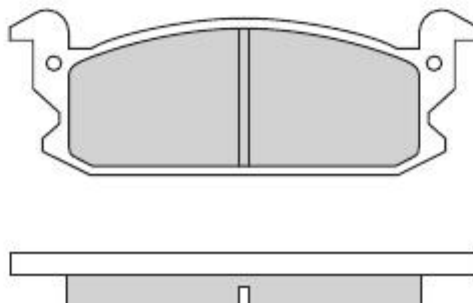



0279	SUZUKI	AKEBONO	X	123	42	15	2A-2B		
-------------	--------	---------	---	-----	----	----	-------	--	--



0280	DAIHATSU	AKEBONO	X	124	44	14	4		
-------------	----------	---------	---	-----	----	----	---	--	--



									
0281	AUDI	GIRLING	X	104,5	67	15,3	4		

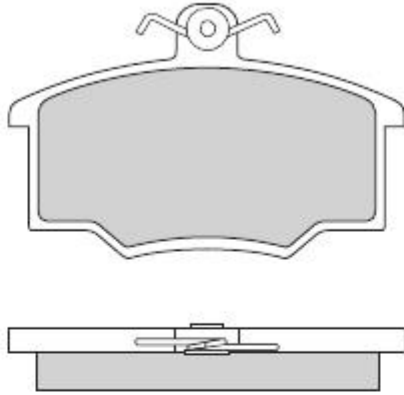



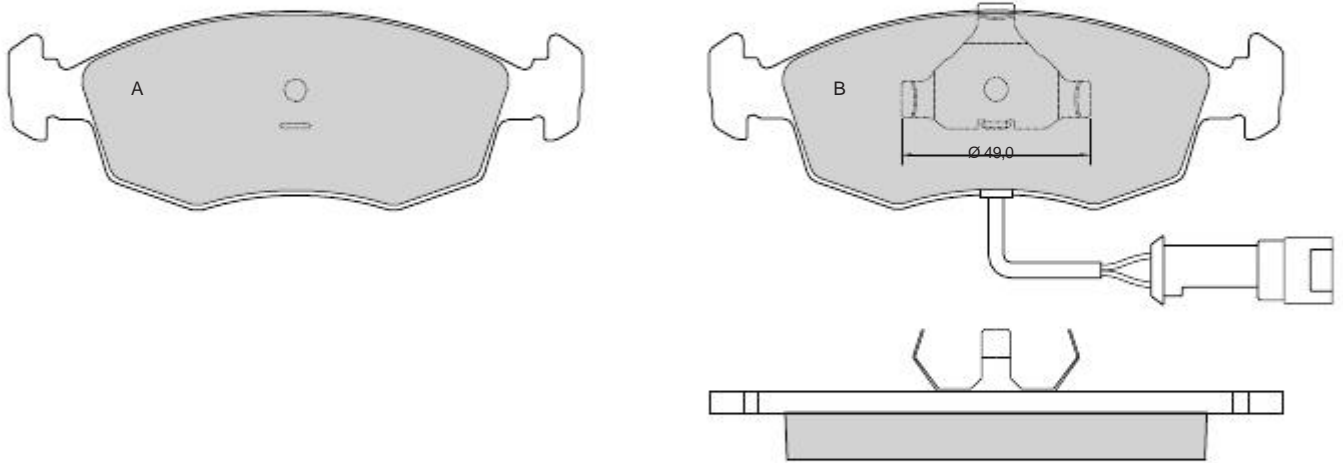



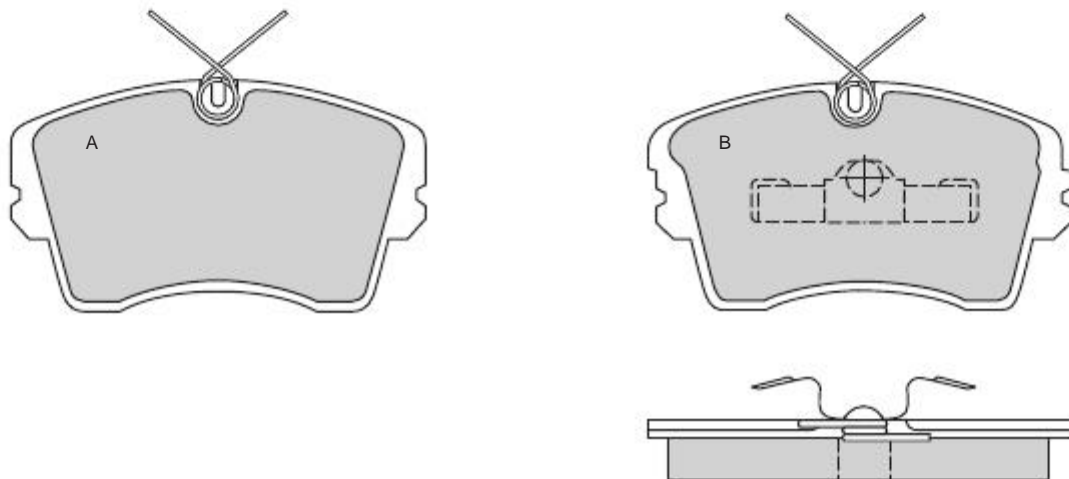

0282	FORD - MERCURY	ATE	X	151,3	52,5	18	2A-2B	2	250
-------------	----------------	-----	---	-------	------	----	-------	---	-----



0283	OPEL	ATE	X	112	60	17,5	2A-2B		
-------------	------	-----	---	-----	----	------	-------	--	--

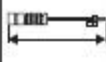

									
0284	FORD	GIRLING	X	89,9	54	13,7	2A-2B	2	250

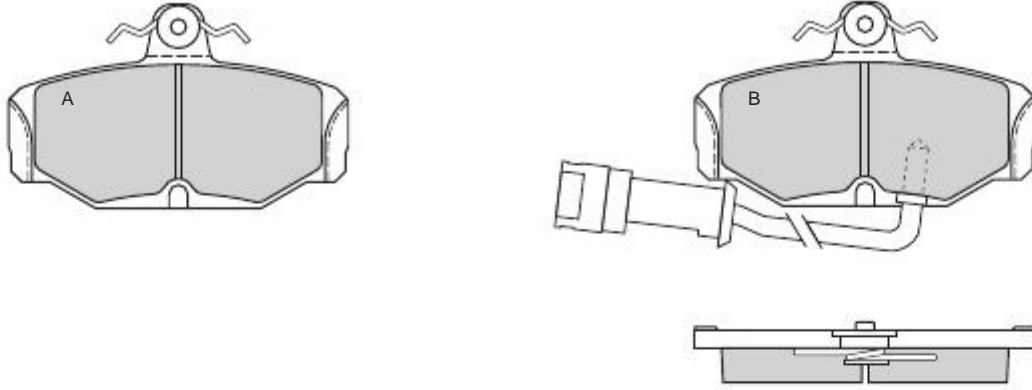



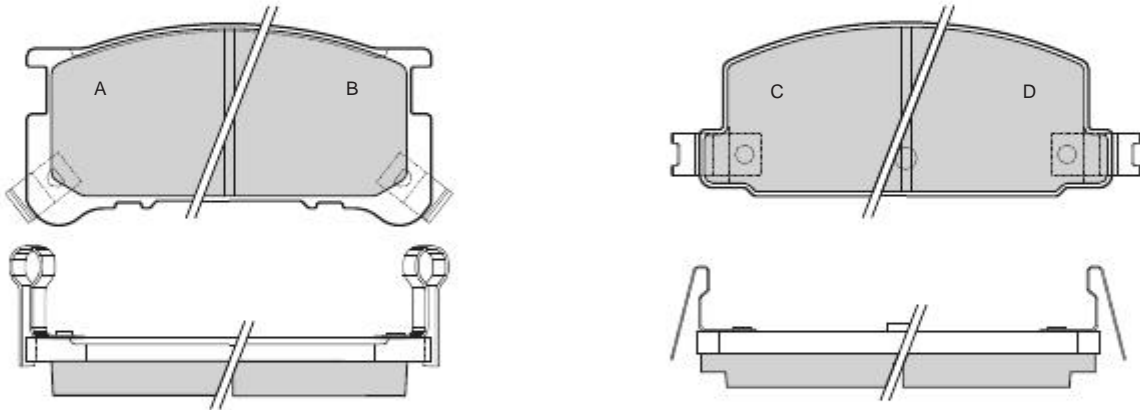



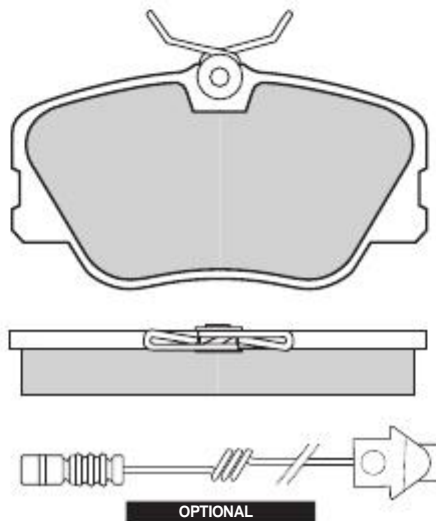



0285	SUBARU	AKEBONO	X	A-B 106,5 C-D 108,6	A-B 53,1 C-D 45,8	15	1A-1B 1C-1D		
------	--------	---------	---	------------------------	----------------------	----	----------------	--	--



0286	MERCEDES	GIRLING	X	110	60	19,2	4	2	220
------	----------	---------	---	-----	----	------	---	---	-----



									
0287	AUDI	GIRLING	X	119,6	69,7	16,6	4		

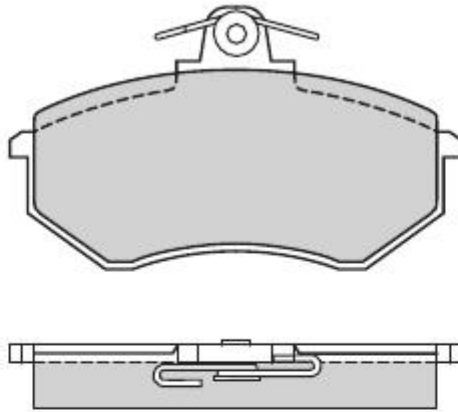



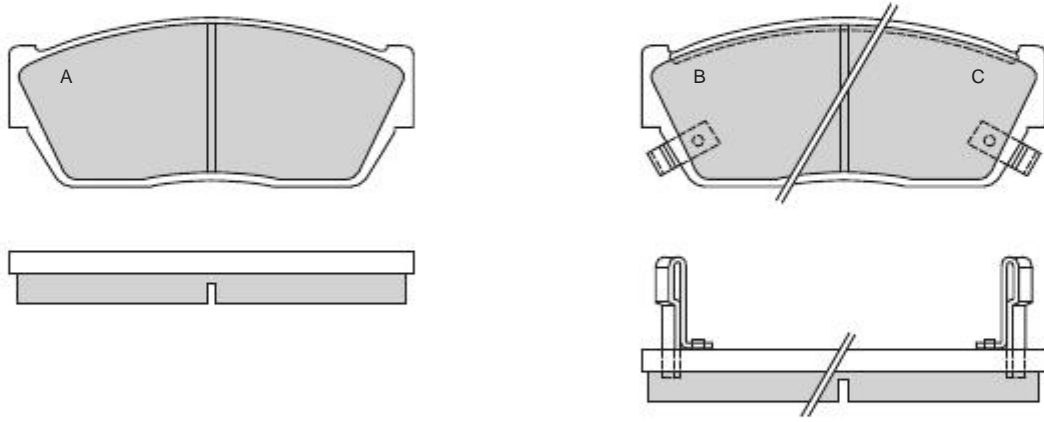



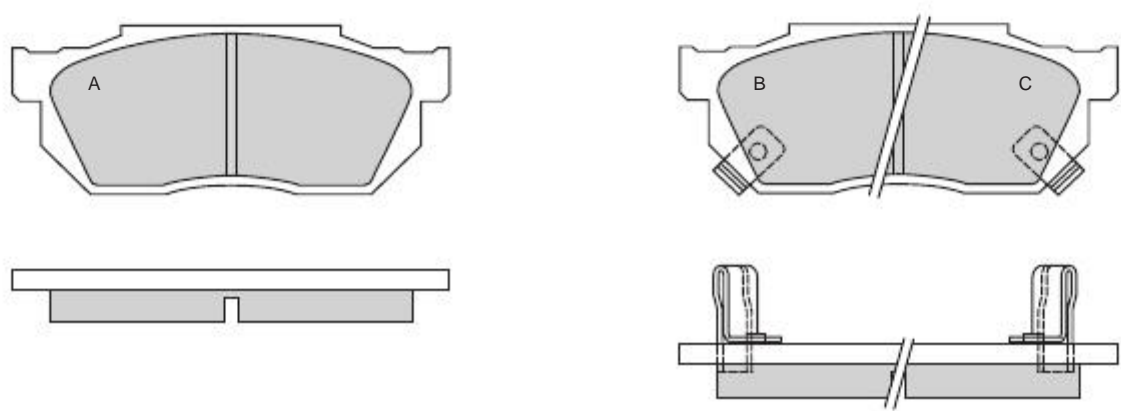

0288	HONDA	SUMITOMO	X	107,3	44,8	15	2A 1B-1C		
-------------	-------	----------	---	-------	------	----	-------------	--	--



0289	HONDA	AKEBONO	X	116	45	15	2A 1B-1C		
-------------	-------	---------	---	-----	----	----	-------------	--	--

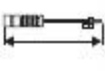

									
0290	HONDA	SUMITOMO	X	119,3	39,5	15,5	2A 1B-1C		

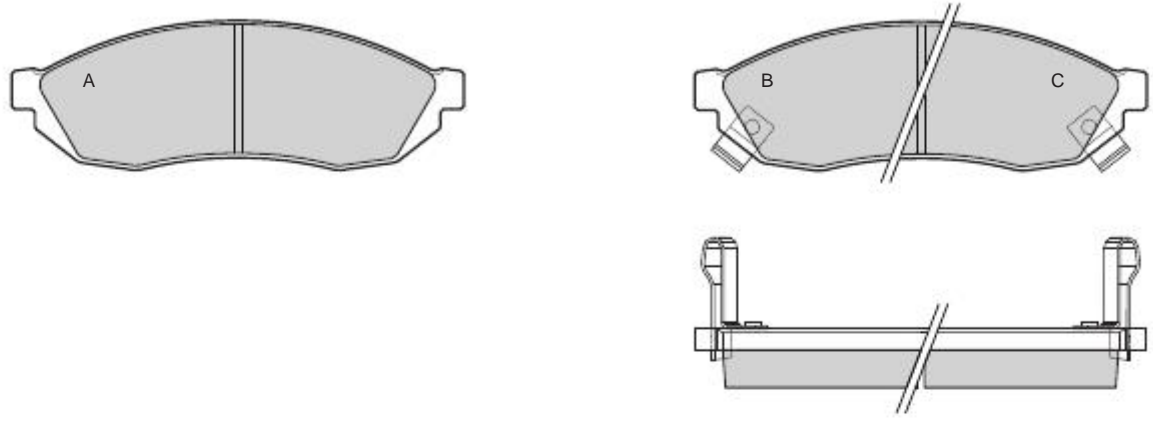



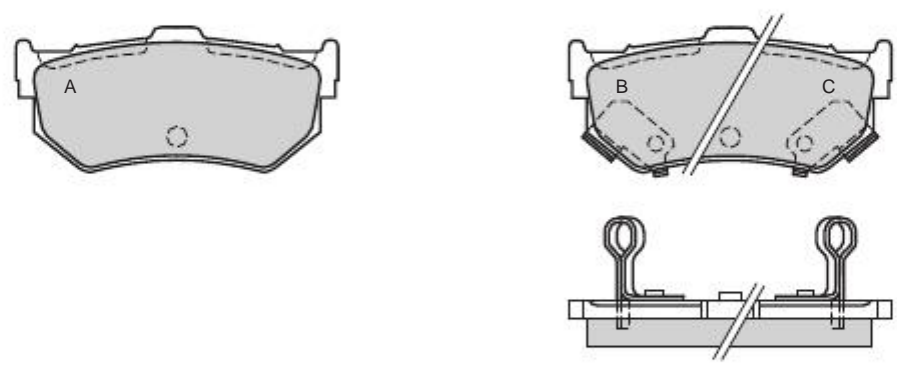



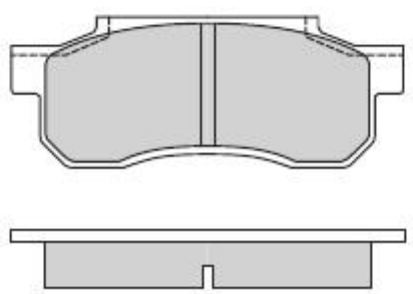

0291	HONDA - SUZUKI	AKEBONO	X	85,7	38,8	13	2A 1B-1C		
-------------	----------------	---------	---	------	------	----	-------------	--	--



0292	HONDA	AKEBONO	X	104	40	15	4		
-------------	-------	---------	---	-----	----	----	---	--	--

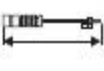

									
0293	HONDA - HYUNDAI	AKEBONO	X	127,4	49	14,9	2A 1B-1C		

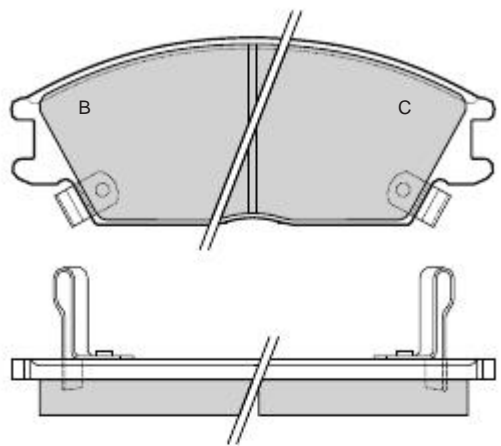
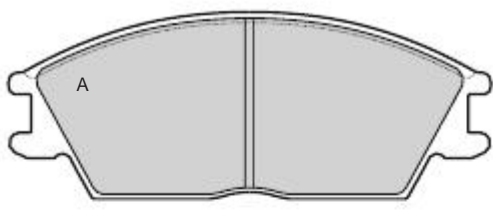



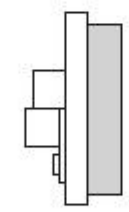
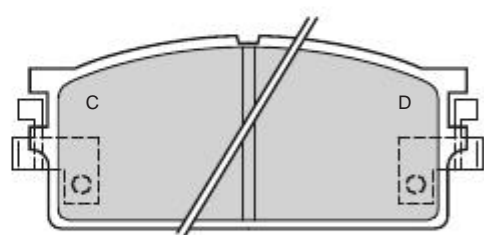
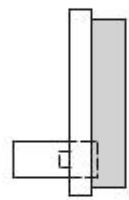
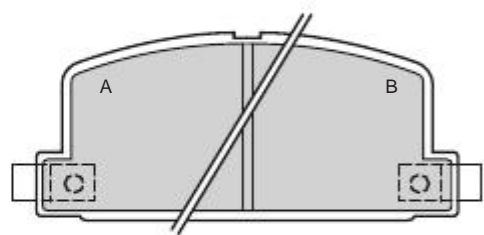



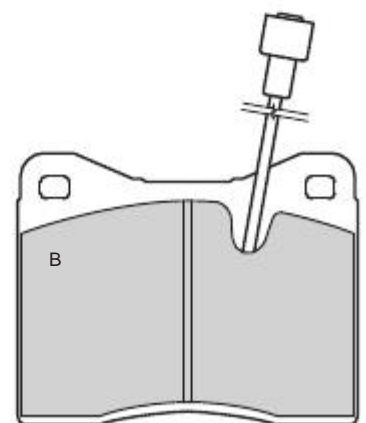
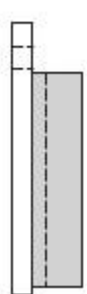
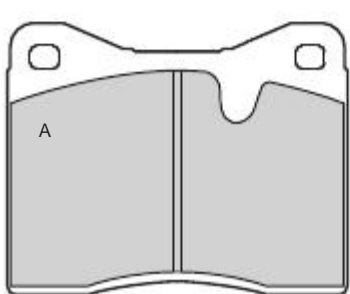



0294	ISUZU - VAUXHALL	AKEBONO	X	A-B 110,5 C-D 115,7	50,5	15	1A-1B 1C-1D		
-------------	------------------	---------	---	------------------------	------	----	----------------	--	--



0295	MASERATI	ATE	X	90	72	19	3A-1B	1	230
-------------	----------	-----	---	----	----	----	-------	---	-----



									
0296	DAIHATSU - MAZDA	SUMITOMO	X	128	57,7	15	4		

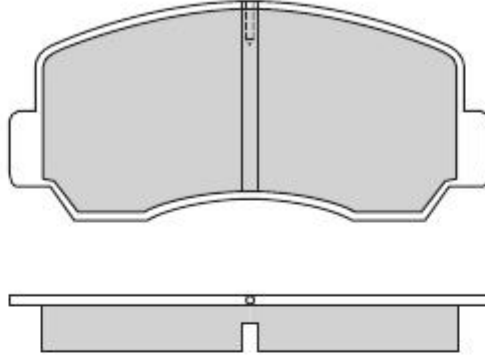



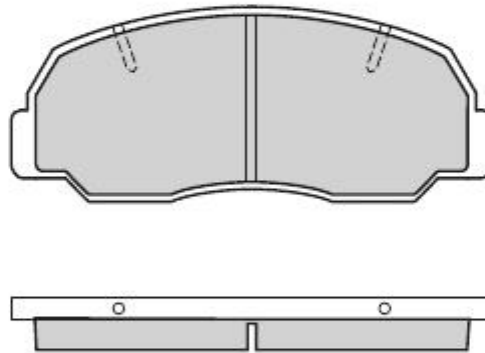



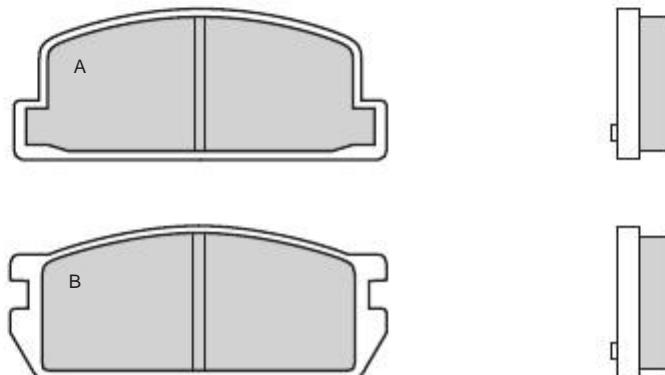



0297	DAIHATSU - MAZDA	AKEBONO	X	127,8	52,3	14	4		
-------------	------------------	---------	---	-------	------	----	---	--	--



0298	MAZDA	AKEBONO	X	A 98,5 B 99	A 39,5 B 41	13	2A-2B		
-------------	-------	---------	---	----------------	----------------	----	-------	--	--



									
0299	MITSUBISHI	AKEBONO	X	127,6	52,5	15,2	4		

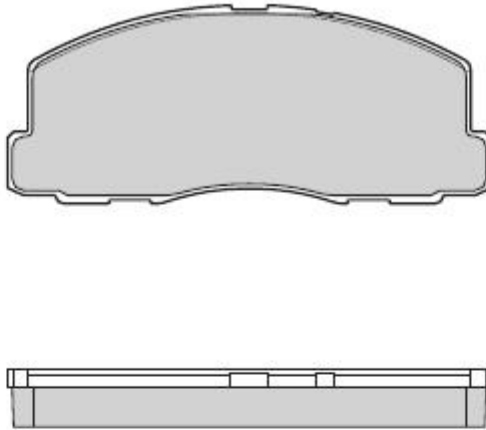



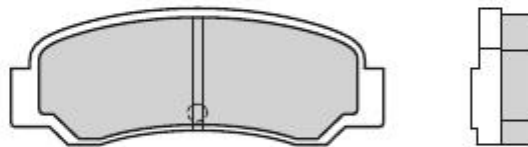



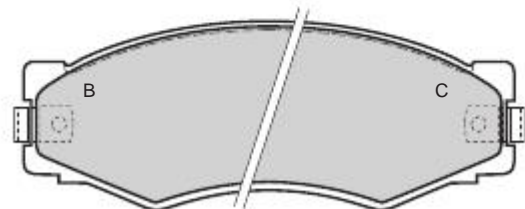
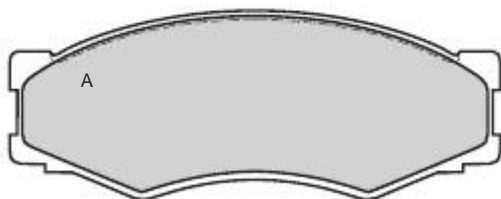

0300	MITSUBISHI	SUMITOMO	X	98,75	36,75	14,5	4		
-------------	------------	----------	---	-------	-------	------	---	--	--



0301	NISSAN	AKEBONO	X	130	49,5	16	2A 1B-1C		
-------------	--------	---------	---	-----	------	----	-------------	--	--

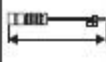

									
0302	NISSAN	AKEBONO	X	130	49,5	17	4		

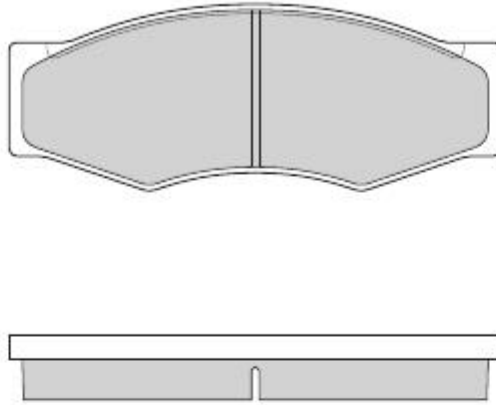



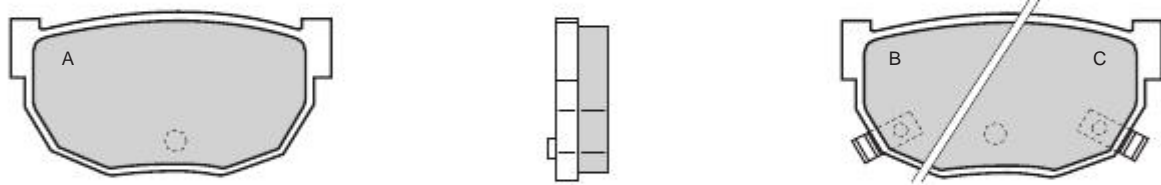



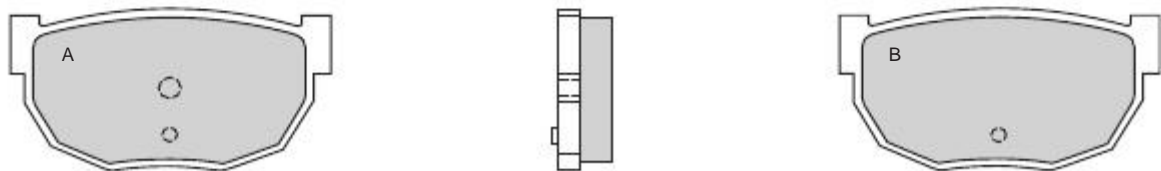



0303	NISSAN-DATSUN	SUMITOMO	X	85	43	14	2A 1B-1C		
-------------	---------------	----------	---	----	----	----	-------------	--	--



0304	NISSAN	AKEBONO	X	85	43	14	2A-2B		
-------------	--------	---------	---	----	----	----	-------	--	--



									
0305	TOYOTA	AKEBONO	X	128,1	52	15,5	4		

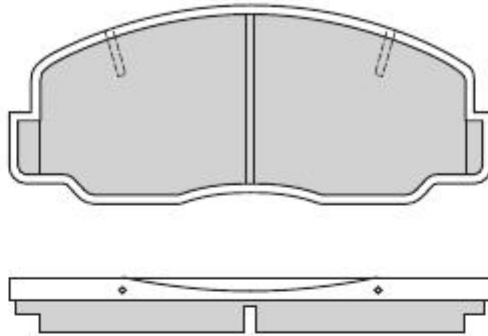



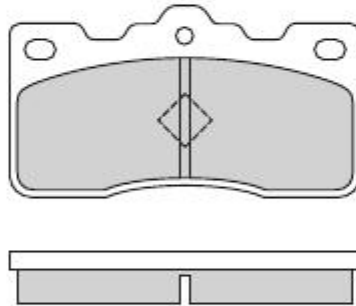



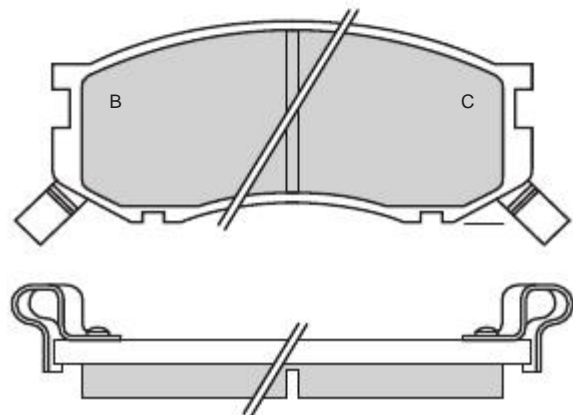
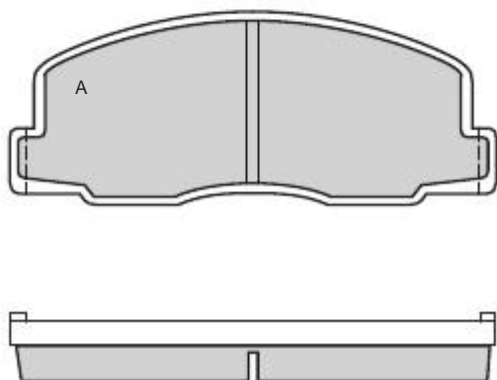



0306	TOYOTA	SUMITOMO	X	92,8	50,5	14,5	4		
-------------	--------	----------	---	------	------	------	---	--	--



0307	TOYOTA	AKEBONO	X	A 128,3 B-C 127	A 52 B-C 55	15,5	2A 1B-1C		
-------------	--------	---------	---	--------------------	----------------	------	-------------	--	--



									
0308	TOYOTA	AKEBONO	X	A 109,4 B-C 107	A 49,1 B-C 52,2	15	2A 1B-1C		

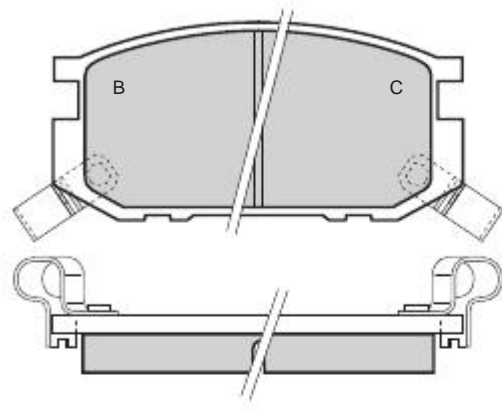
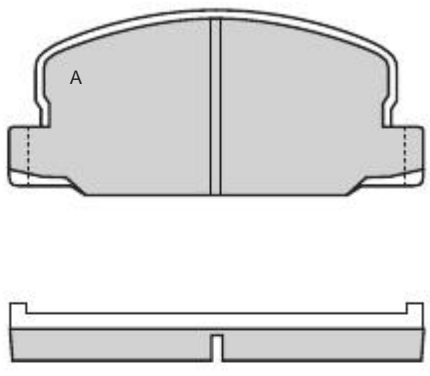



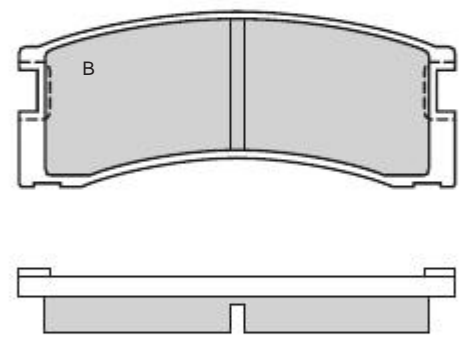
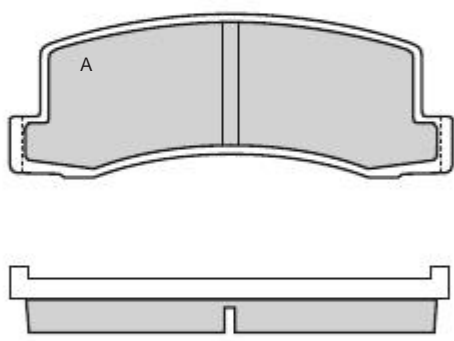



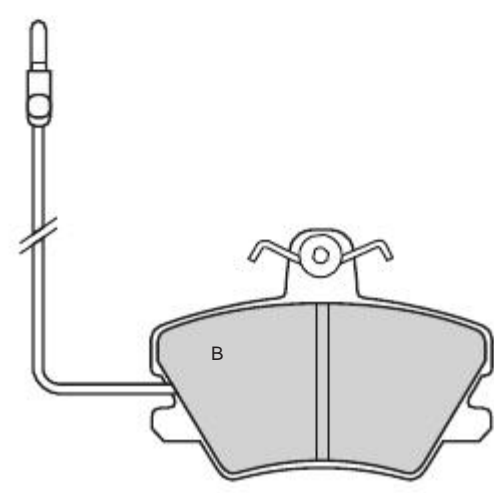
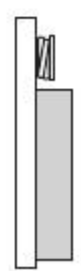
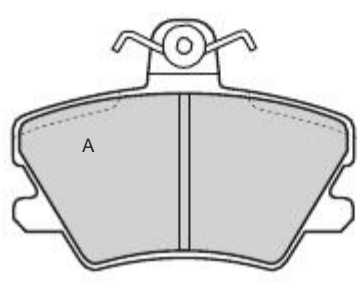



0309	TOYOTA	AKEBONO	X	A 117 B 115	A 44 B 47	15	2A-2B		
-------------	--------	---------	---	----------------	--------------	----	-------	--	--



0310	RENAULT	GIRLING	X	90	66	15	2A-2B	2	220
-------------	---------	---------	---	----	----	----	-------	---	-----



									
0311	CITROEN	GIRLING	X	89,95	63	17,7	2A-2B	2	220

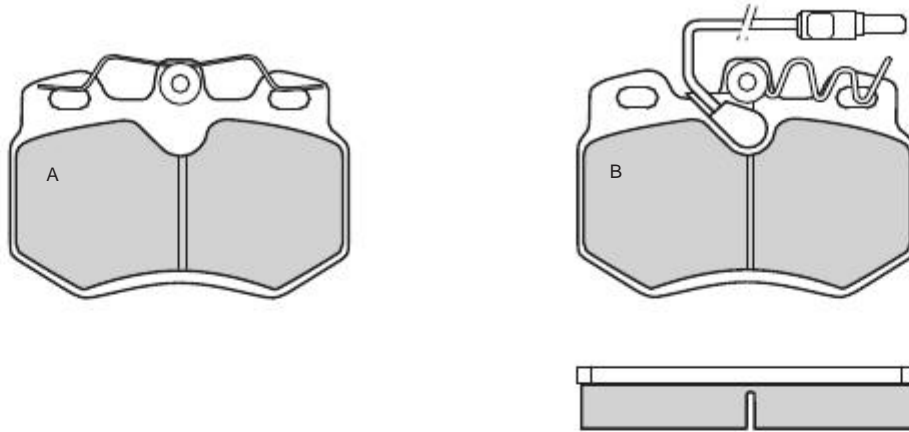



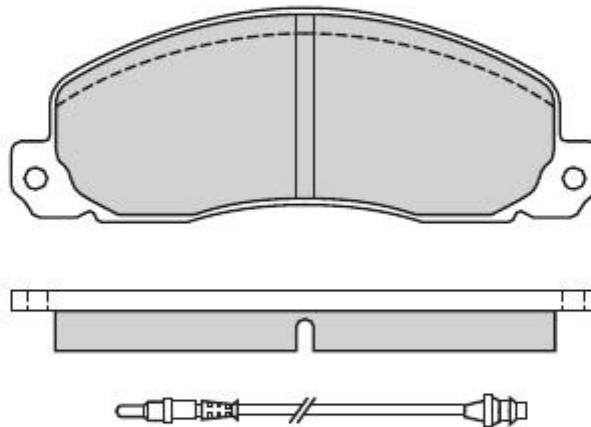



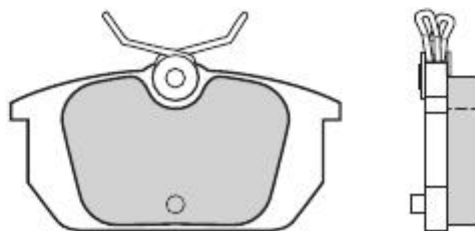

0312	RENAULT	BENDIX	X	156	56,5	18,5	4	2	325
-------------	---------	--------	---	-----	------	------	---	---	-----



0313	ALFA ROMEO - AUTOBIANCHI FIAT - LANCIA	GIRLING	X	87,6	45	14,4	4		
-------------	---	---------	---	------	----	------	---	--	--

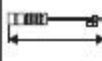

									
0314	MERCEDES	ATE	X	61,7	54,5	15,5	4		

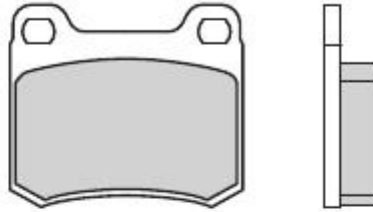



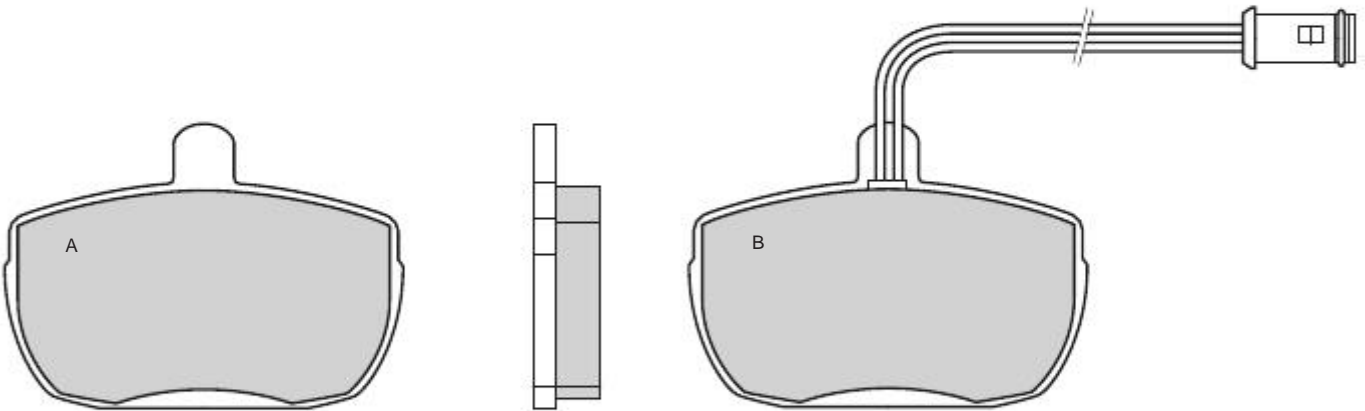



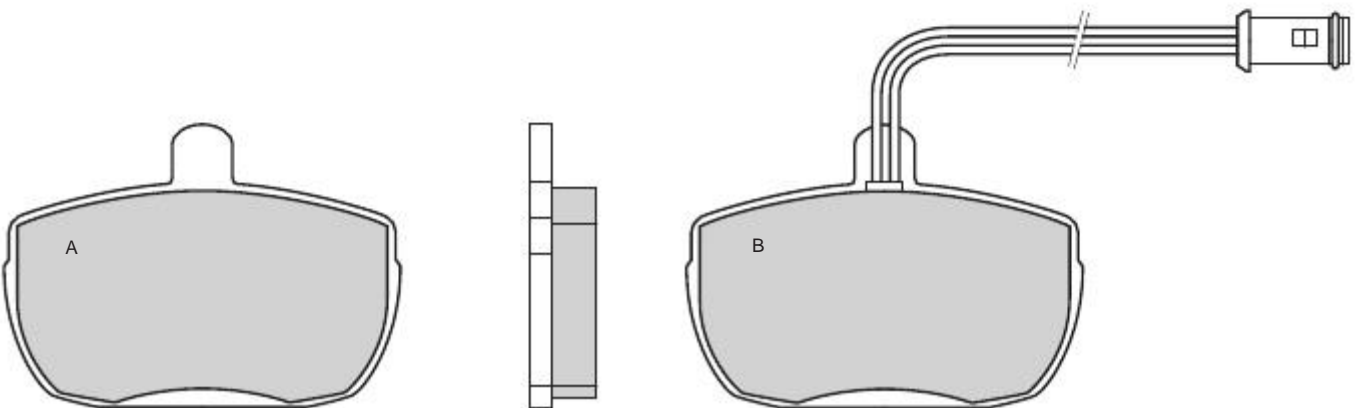



0315	IVECO	LOCKHEED	X	105	75	18	3A-1B	1	225
-------------	-------	----------	---	-----	----	----	-------	---	-----



0315/1	DAF - FORD LEYLAND	LOCKHEED	X	105	75	18	2A-2B	2	430
---------------	-----------------------	----------	---	-----	----	----	-------	---	-----



									
0316	FORD	BENDIX	X	116,8	59	17,5	4		

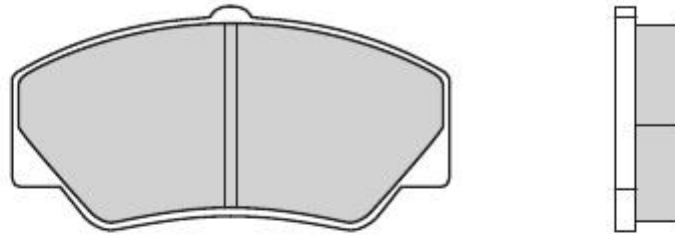



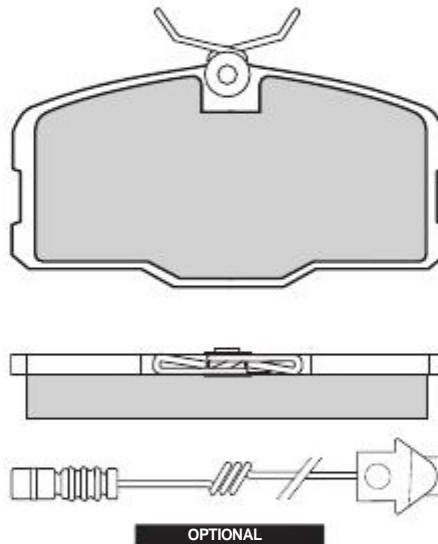



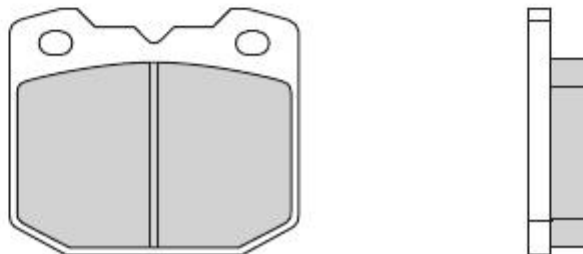



0317	MERCEDES	GIRLING	X	114,8	59,9	18,5	4	2	200
-------------	----------	---------	---	-------	------	------	---	---	-----



0318	ALFA ROMEO	ATE	X	77	66	16,4	4		
-------------	------------	-----	---	----	----	------	---	--	--



									
0319	ALFA ROMEO	ATE	X	100,05	54,9	15	2A 1B-1C	2	800

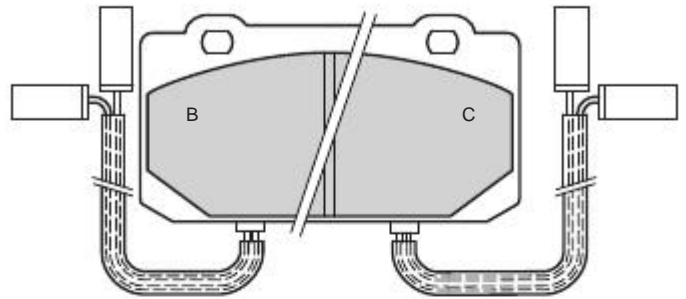
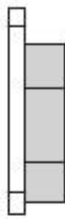
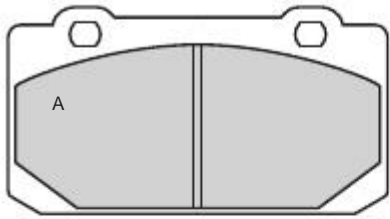



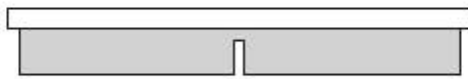
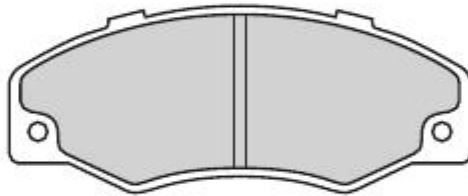



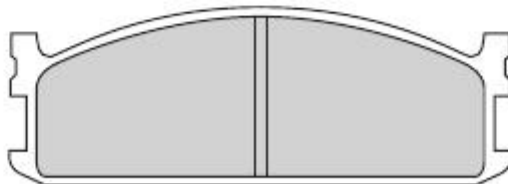

0320	RENAULT	BENDIX	X	123	48,6	17	4	2	200
------	---------	--------	---	-----	------	----	---	---	-----



0321	ISUZU - VAUXHALL	SUMITOMO	X	133,3	47,3	15,5	4		
------	------------------	----------	---	-------	------	------	---	--	--

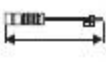

									
0322	TOYOTA - VOLKSWAGEN	AKEBONO	X	142,5	55,6	15,6	4		

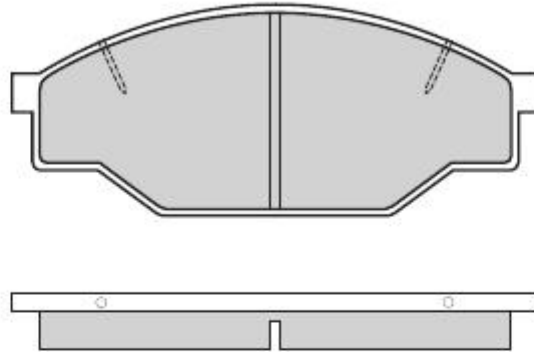



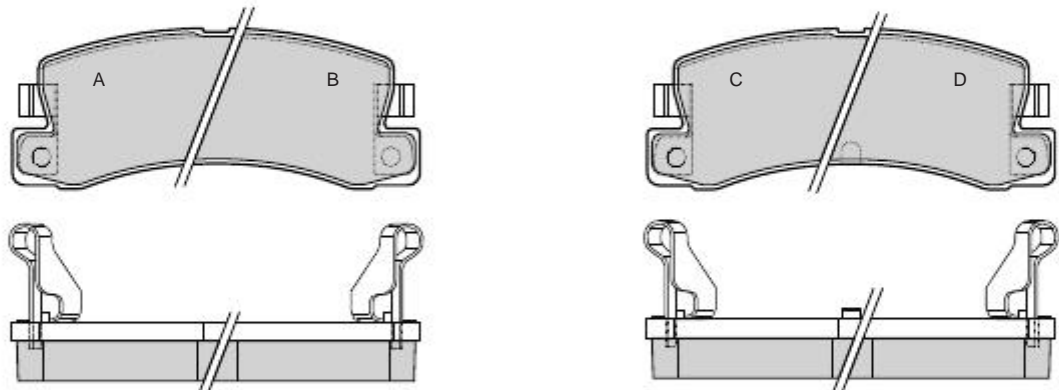



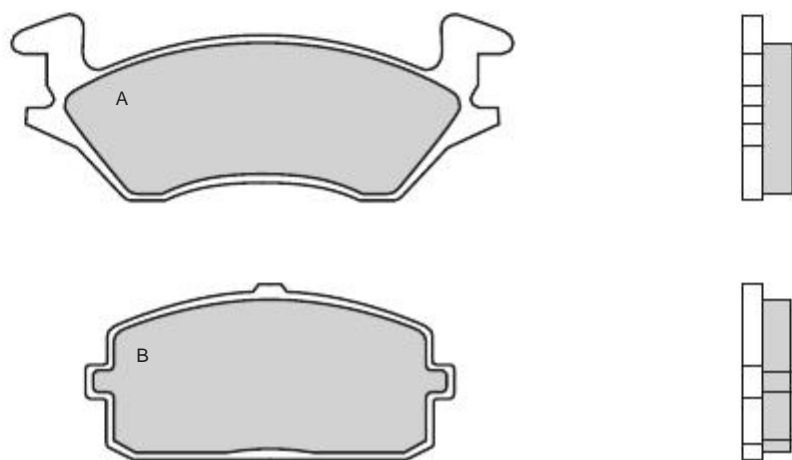



0323	TOYOTA	AKEBONO	X	107,6	42,5	15,6	1A-1B 1C-1D		
------	--------	---------	---	-------	------	------	----------------	--	--



0324	TOYOTA	AKEBONO	X	A 132 B 98	47	13,7	2A-2B		
------	--------	---------	---	---------------	----	------	-------	--	--



									
0325	TOYOTA	AKEBONO	X	A 98,6 B 106,8	A 47,2 B 46,9	A 16 B 15	2A 1B-1C		

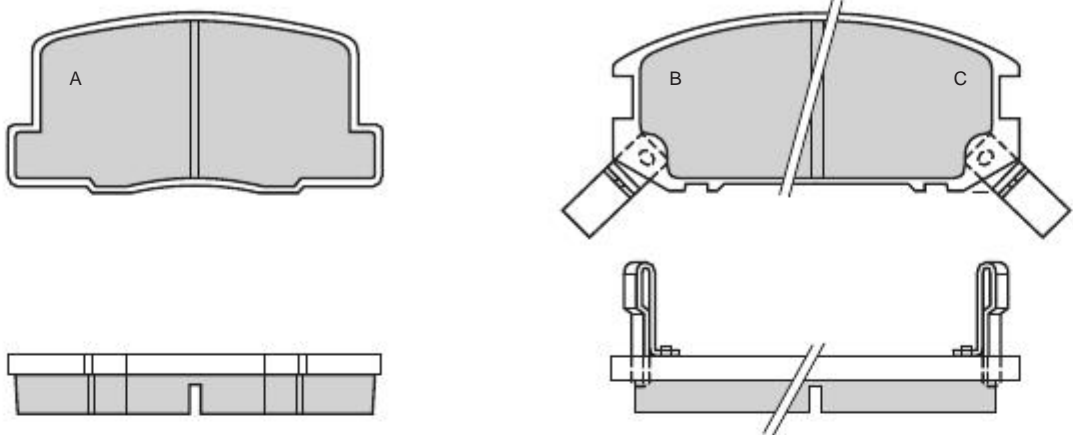



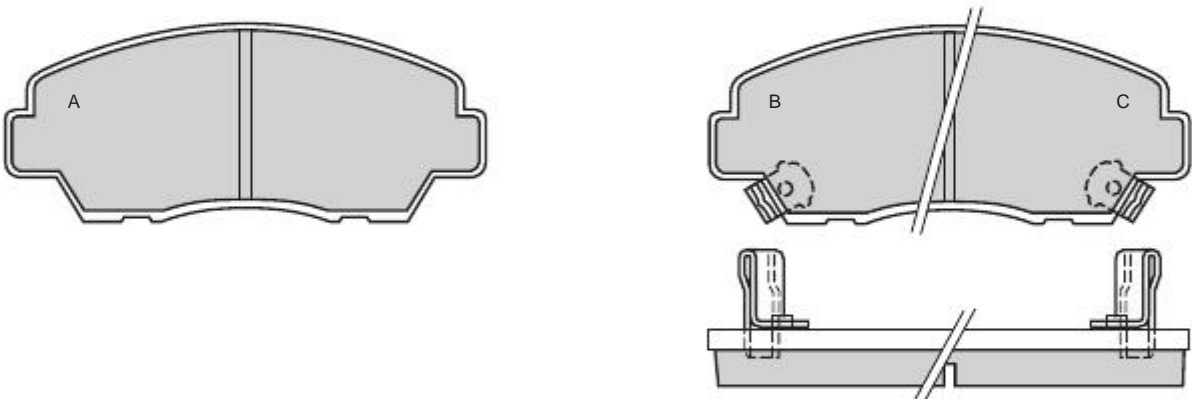



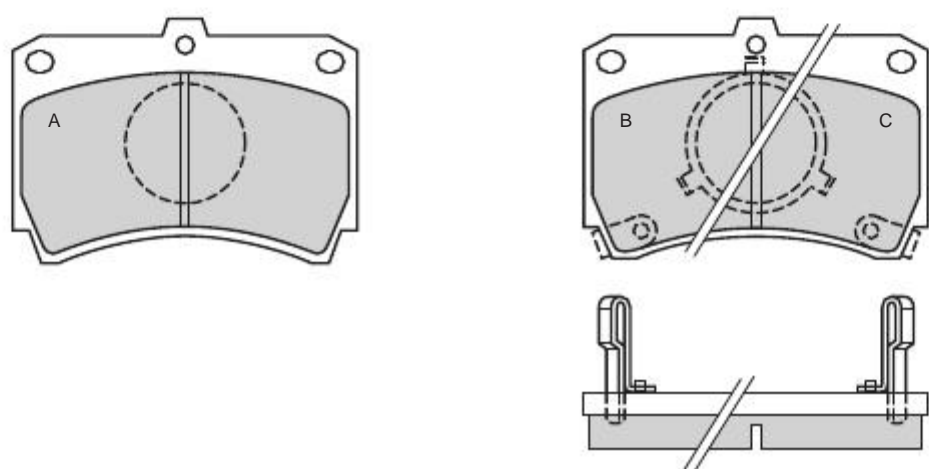



0326	MAZDA	SUMITOMO	X	127,8	52,4	15	2A 1B-1C		
------	-------	----------	---	-------	------	----	-------------	--	--



0327	MAZDA	SUMITOMO	X	91,4	64	15	2A 1B-1C		
------	-------	----------	---	------	----	----	-------------	--	--



									
0328	MAZDA	AKEBONO	X	101,7	42,1	13	4		

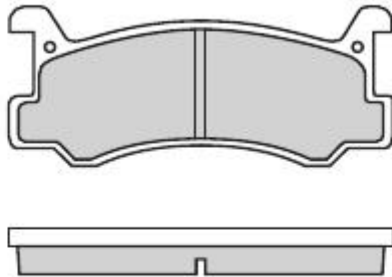



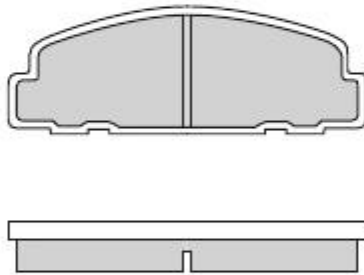



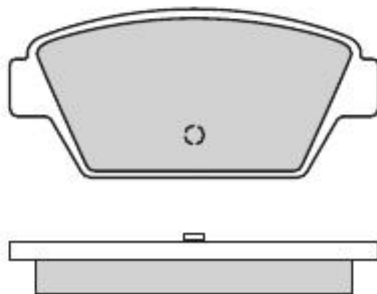



0329	DAIHATSU	AKEBONO	X	94,85	34,4	14	4		
-------------	----------	---------	---	-------	------	----	---	--	--



0330	MITSUBISHI	AKEBONO	X	98,3	44,4	14,5	4		
-------------	------------	---------	---	------	------	------	---	--	--



									
0331	MITSUBISHI	AKEBONO	X	108	40,6	13	4		

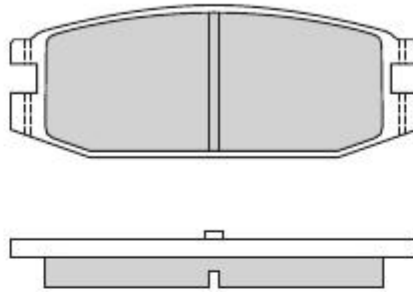



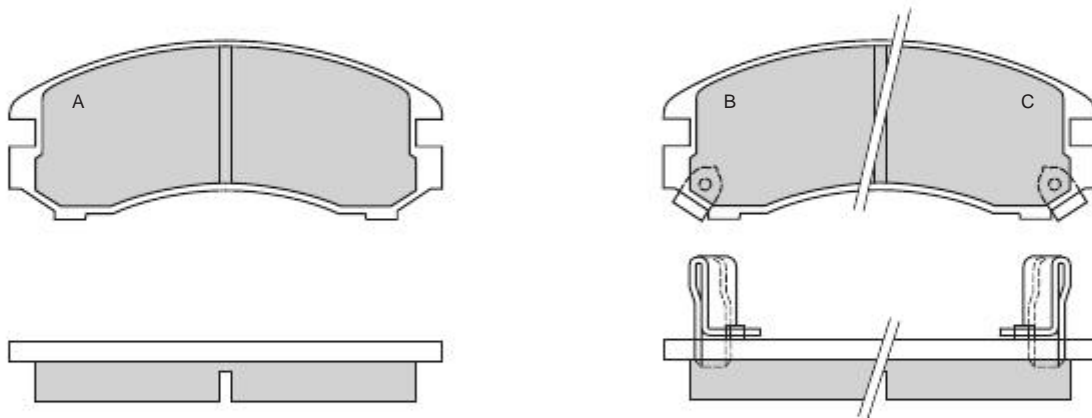



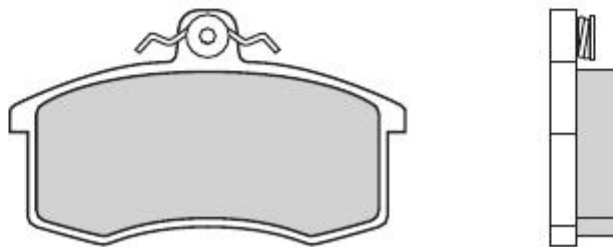

0332	NISSAN - SUZUKI	AKEBONO	X	114,9	47,6	16	2A 1B-1C		
-------------	-----------------	---------	---	-------	------	----	-------------	--	--



0333	LADA	GIRLING	X	104,2	62,4	17,5	4		
-------------	------	---------	---	-------	------	------	---	--	--

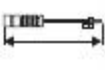

									
0334	RENAULT	BENDIX	X	105	55	15	4	2	200

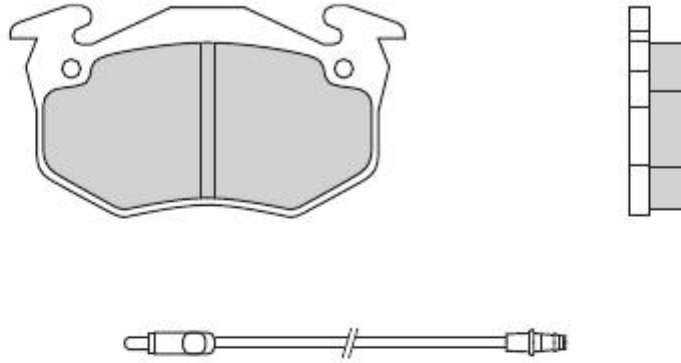



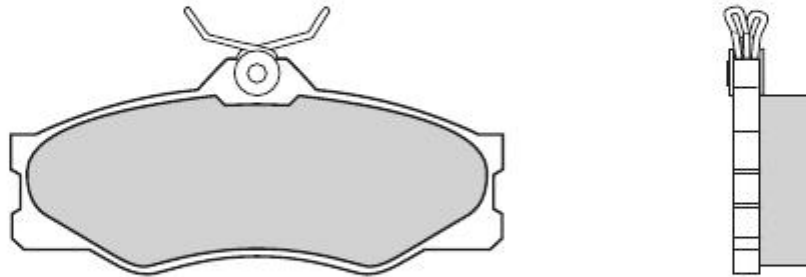



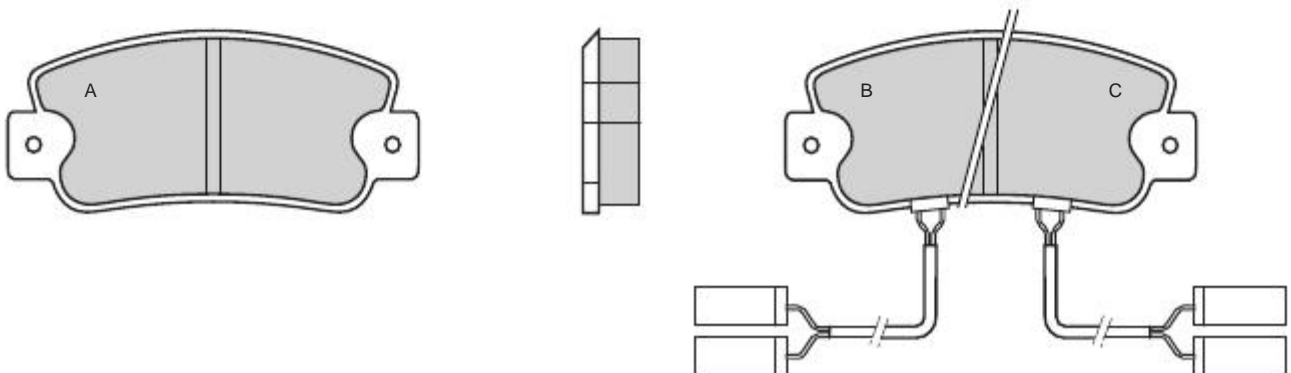



0335	VOLKSWAGEN	GIRLING	X	130	57	19,5	4		
------	------------	---------	---	-----	----	------	---	--	--



0336	ALFA ROMEO	BENDIX	X	109	48	15	2A 1B-1C	2	800
------	------------	--------	---	-----	----	----	-------------	---	-----



									
0337	CITROEN - FIAT - PEUGEOT	GIRLING	X	144,9	71,7	19,5	2A-2B	2	200

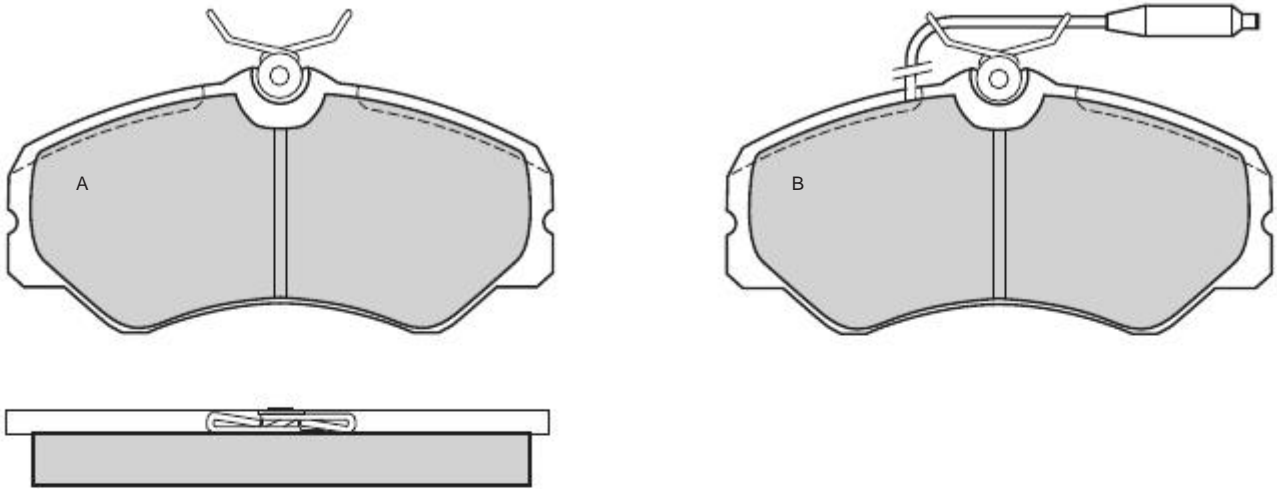



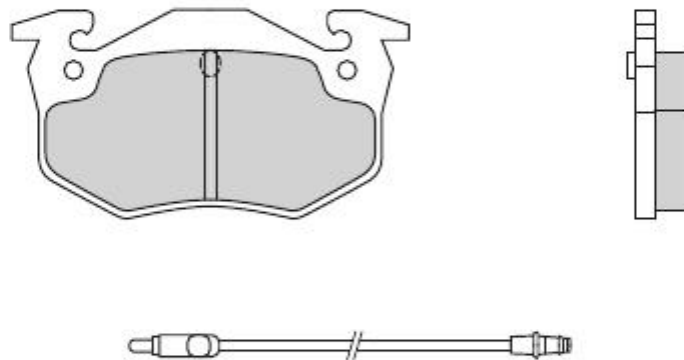



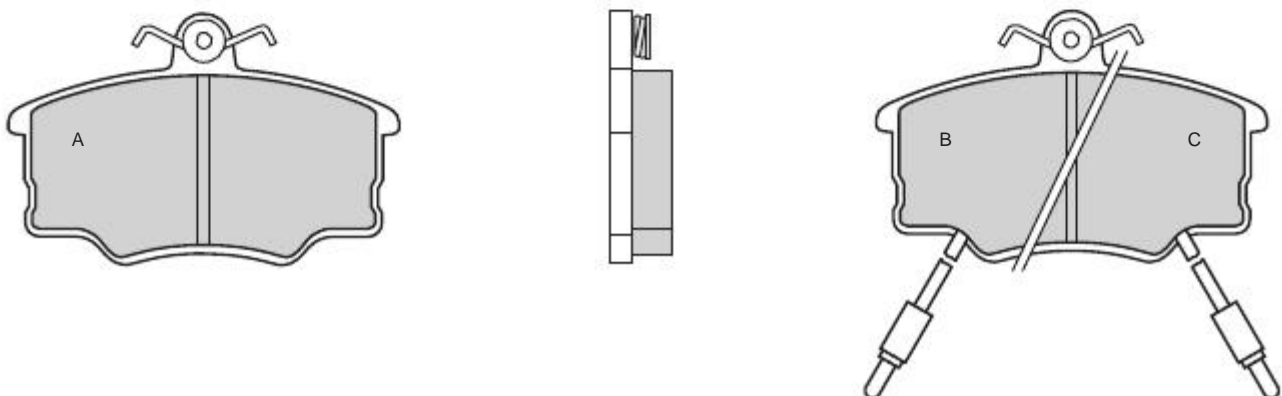

0338	PEUGEOT - RENAULT	BENDIX	X	106	55,1	15	4	2	200
-------------	-------------------	--------	---	-----	------	----	---	---	-----



0339	FIAT - LANCIA	GIRLING	X	104,2	66,6	17	2A 1B-1C	2	110
-------------	---------------	---------	---	-------	------	----	-------------	---	-----

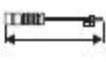

									
0340	RENAULT	GIRLING	X	119,6	71,1	15,5	2A-2B	2	110

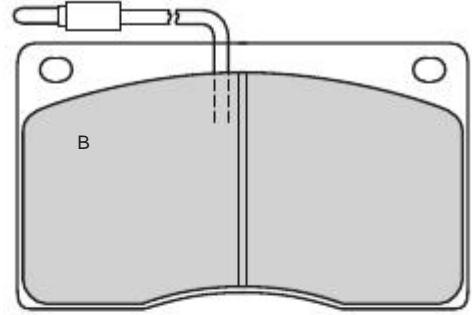
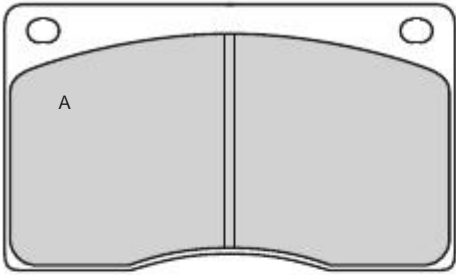



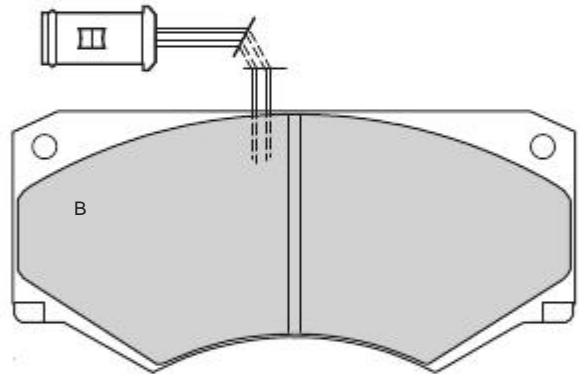
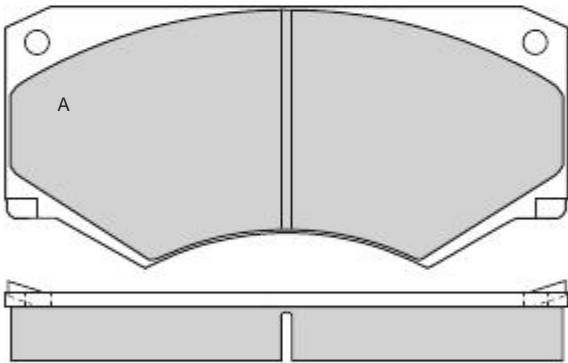



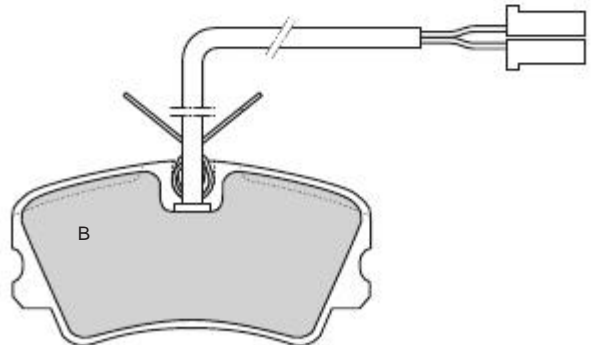
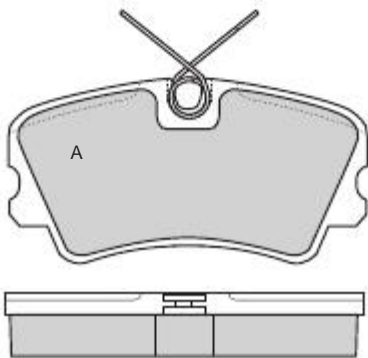

0341	IVECO	PERROT	X	149	69	18	2A-2B	2	170
-------------	-------	--------	---	-----	----	----	-------	---	-----



0342	ALFA ROMEO	ATE	X	95	48,6	16,5	2A-2B	2	800
-------------	------------	-----	---	----	------	------	-------	---	-----

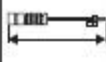

									
0343	FIAT	ATE	X	151,4	50	18	2A-2B	2	810

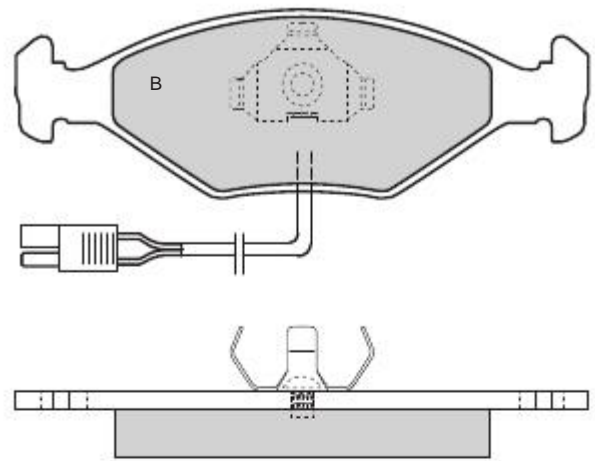



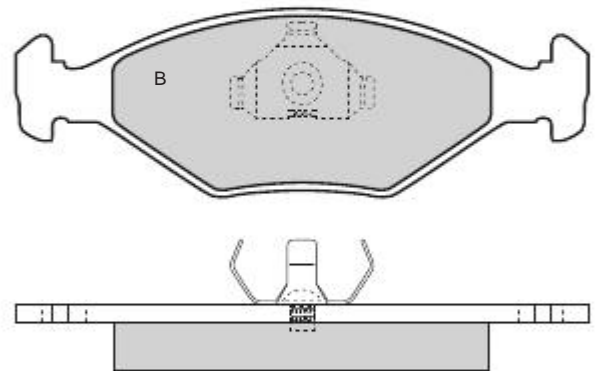
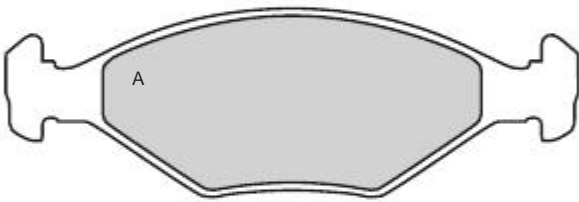



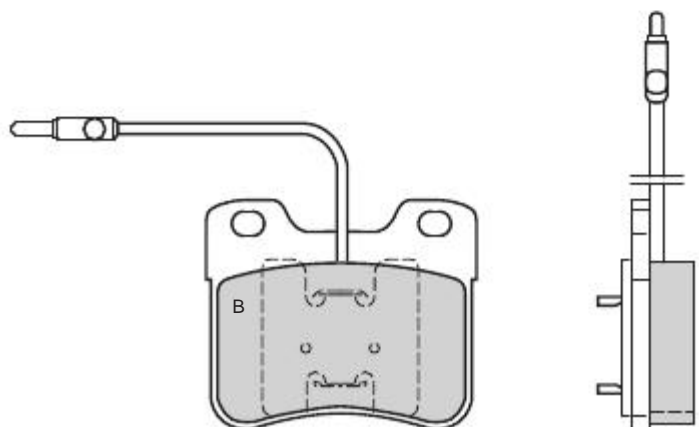
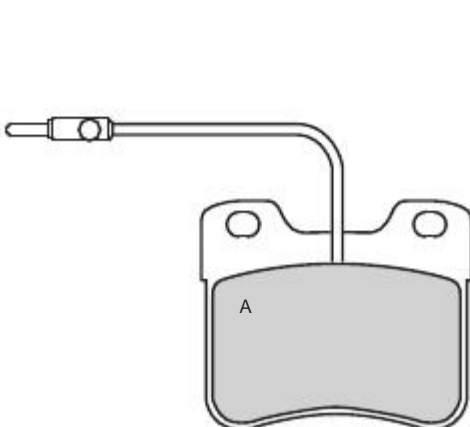

0343/1	FIAT	ATE	X	151,4	50	17,5	2A-2B		
--------	------	-----	---	-------	----	------	-------	--	--

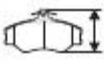

0344	CITROEN	CITROEN	X	72	61	17	2A-2B	4	175
------	---------	---------	---	----	----	----	-------	---	-----

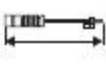

									
0346	SUBARU	AKEBONO	X	85,4	36,5	14,8	2A 1B-1C		

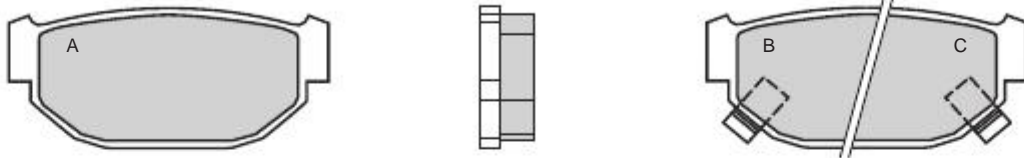



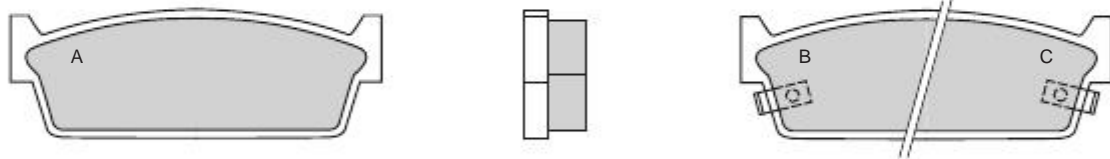



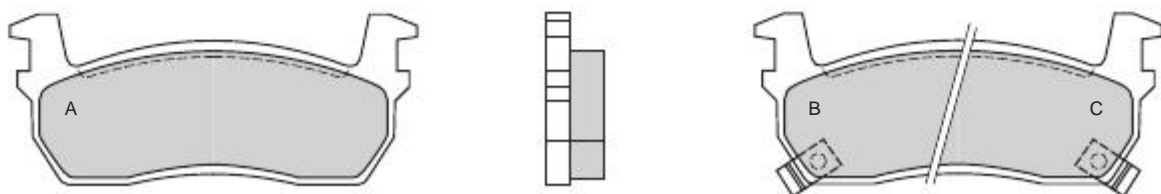

0347	NISSAN	SUMITOMO	X	98,7	33,9	15,9	2A 1B-1C		
-------------	--------	----------	---	------	------	------	-------------	--	--



0348	NISSAN	AKEBONO	X	108,4	45,5	15,7	2A 1B-1C		
-------------	--------	---------	---	-------	------	------	-------------	--	--

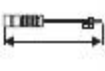

									
0349	HONDA	AKEBONO	X	127,7	48,6	15	2A 1B-1C		

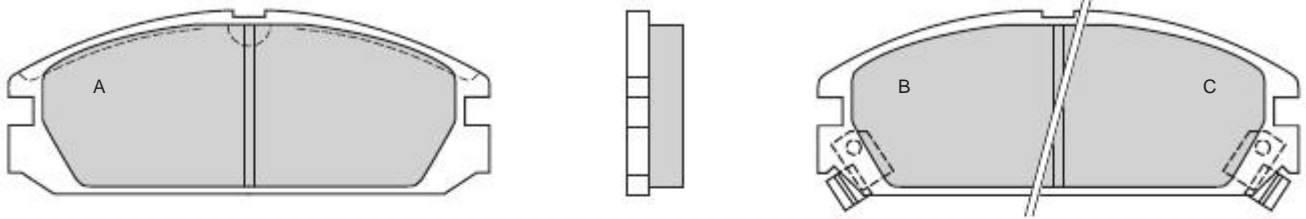



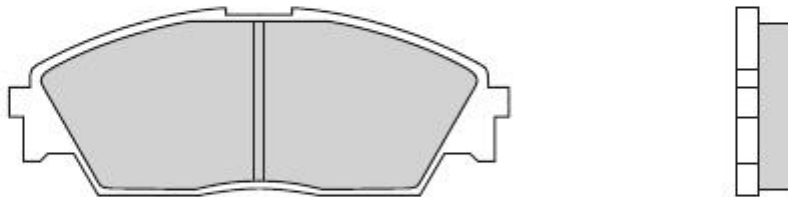



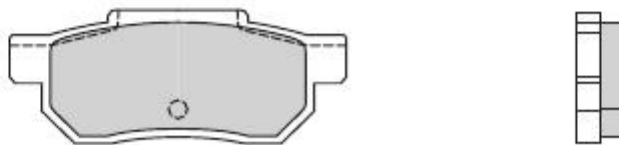



0350	HONDA	AKEBONO	X	132,2	49,5	15	4		
-------------	-------	---------	---	-------	------	----	---	--	--



0351	HONDA	AKEBONO	X	89	35,2	13	4		
-------------	-------	---------	---	----	------	----	---	--	--



									
0352	MAZDA	AKEBONO	X	A 116,1 B-C 103,1	A 49,65 B-C 53,85	15	2A 1B-1C		

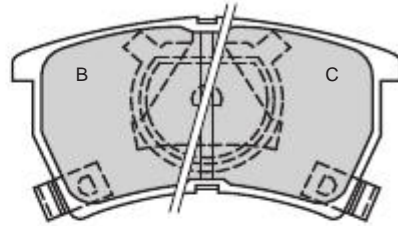
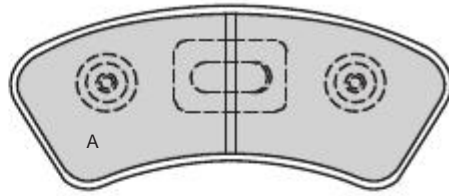



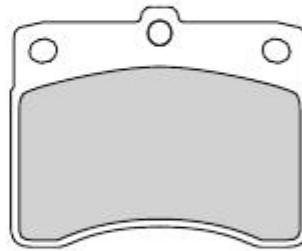



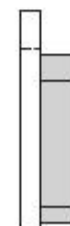
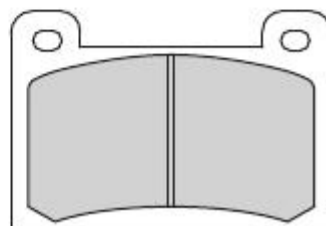

0353	DAIHATSU - PIAGGIO	AKEBONO	X	78,65	63,9	13,4	4		
------	--------------------	---------	---	-------	------	------	---	--	--



0354	SKODA - WARTBURG	SKODA	X	85,3	57,3	14,8	4		
------	------------------	-------	---	------	------	------	---	--	--

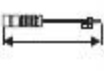

									
0355	ROVER	SUMITOMO	X	107,4	44,7	15	3A-1B		225

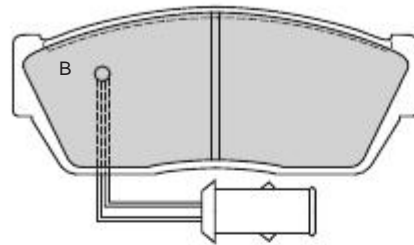
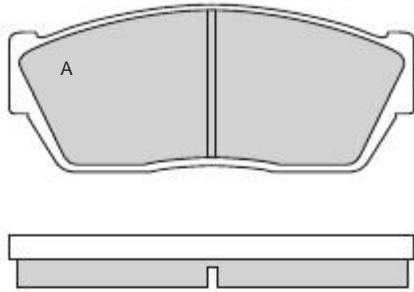







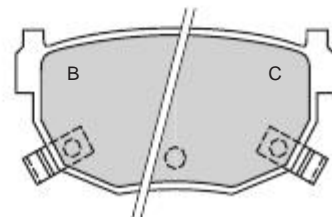
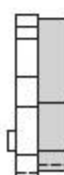

0356	CITROEN	CITROEN	X	54,1	57,4	13	4		
-------------	---------	---------	---	------	------	----	---	--	--



0357	NISSAN	AKEBONO	X	85,1	43,4	14	2A 1B-1C		
-------------	--------	---------	---	------	------	----	-------------	--	--

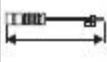

									
0358	SUBARU	AKEBONO	X	127	54,8	18	2A-2B		

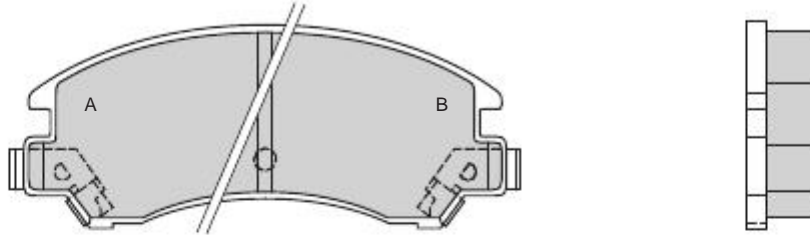



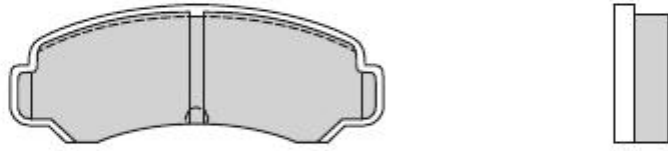



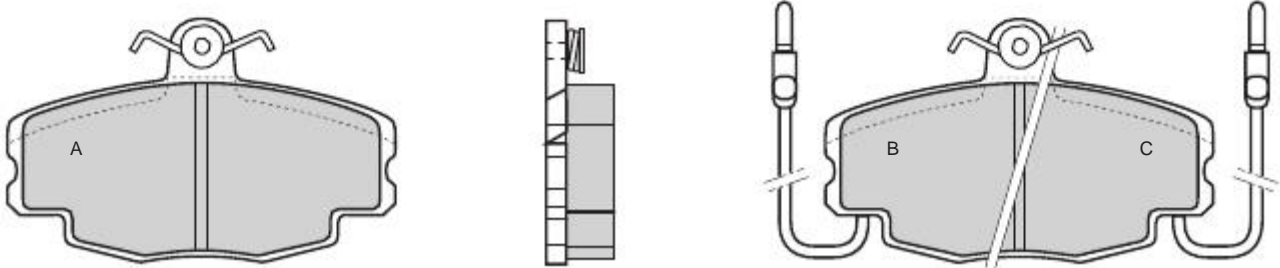



0359	TOYOTA	SUMITOMO	X	98,7	36,75	14,5	4		
------	--------	----------	---	------	-------	------	---	--	--



0360	RENAULT	GIRLING	X	100	64	18	2A 1B-1C	2	220
------	---------	---------	---	-----	----	----	-------------	---	-----



									
0361	LAND ROVER	LOCKHEED	X	88,55	72,2	15	3A-1B	1	225

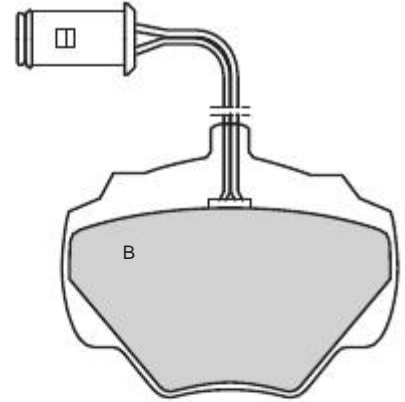
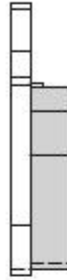
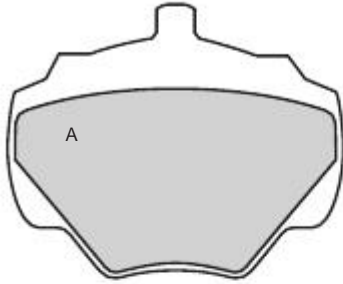



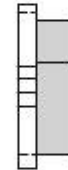
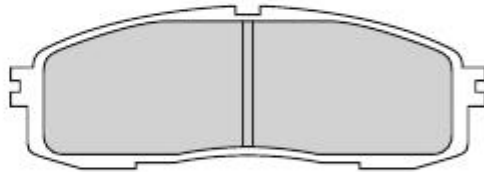



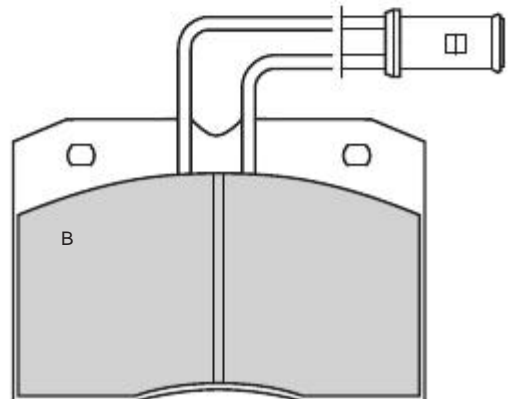
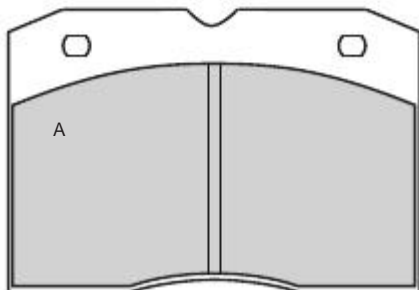

0362	TOYOTA	SUMITOMO	X	125,4	42,4	15,2	4		
-------------	--------	----------	---	-------	------	------	---	--	--



0363	ALFA ROMEO - FIAT RENAULT	BREMBO	X	109,7	75	18	2A-2B	2	170
-------------	------------------------------	--------	---	-------	----	----	-------	---	-----

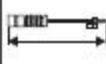

									
0364	ALFA ROMEO	BREMBO	X	76,95	62	14,8	3A-1B	1	800

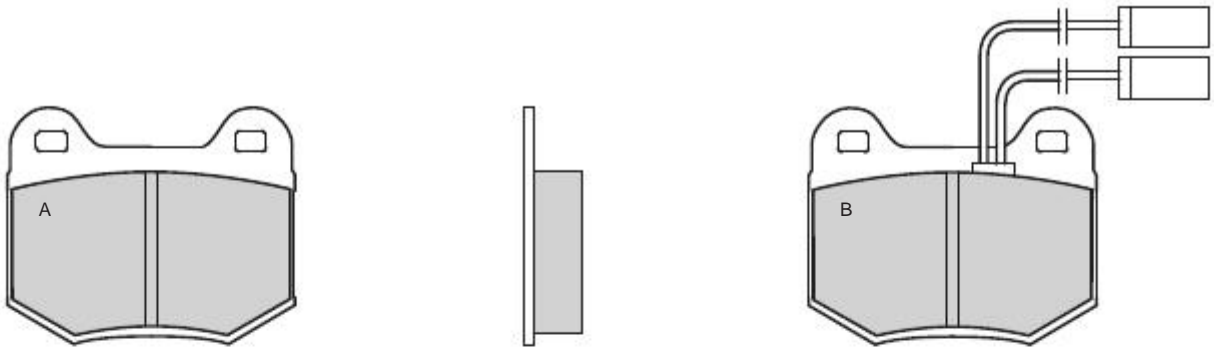



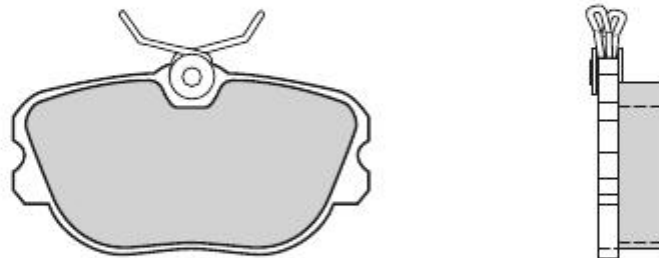



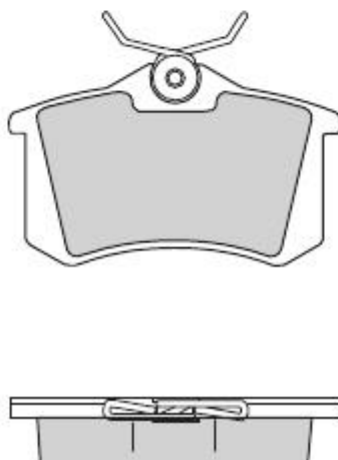



0365	SAAB	GIRLING	X	95	52,5	17,5	4		
-------------	------	---------	---	----	------	------	---	--	--



0366	FORD - SEAT - VOLKSWAGEN	GIRLING	X	87	52,9	16,5	4		
-------------	--------------------------	---------	---	----	------	------	---	--	--



									
0367	ISUZU	AKEBONO	X	127,1	50,9	16,5	2A-2B		

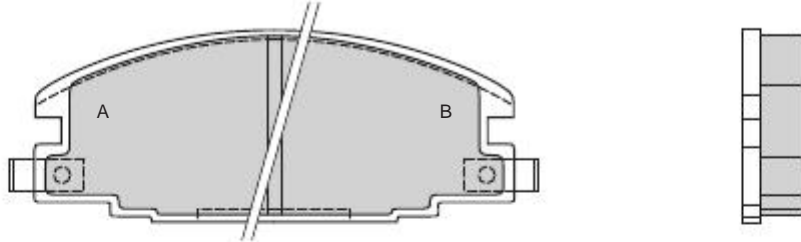



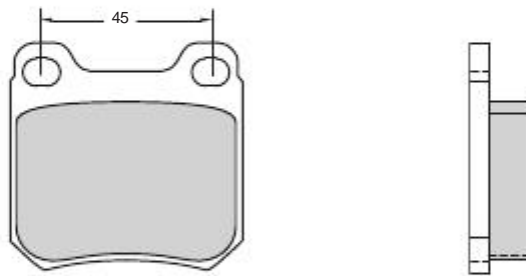



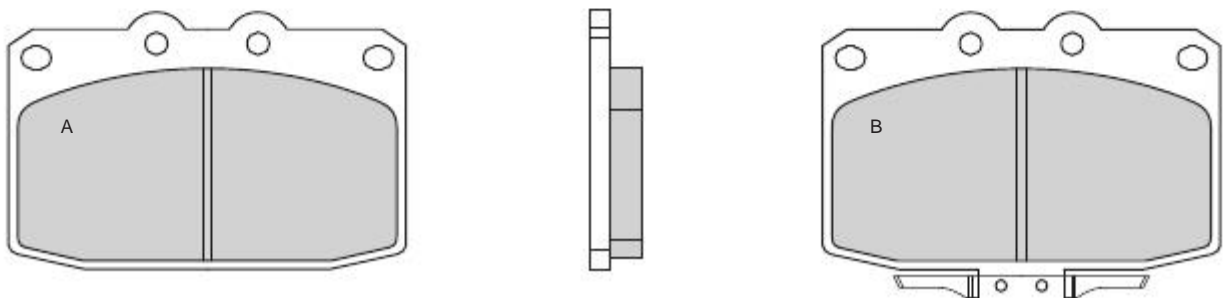

0368	OPEL - SAAB - VAUXHALL	DELCO	X	61,8	61	15	4		
-------------	------------------------	-------	---	------	----	----	---	--	--



0369	MAZDA	AKEBONO	X	106,6	67,5	14,5	2A-2B		
-------------	-------	---------	---	-------	------	------	-------	--	--

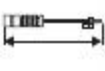

									
0370	NISSAN	AKEBONO	X	160,9	49,3	17	2A 1B-1C		

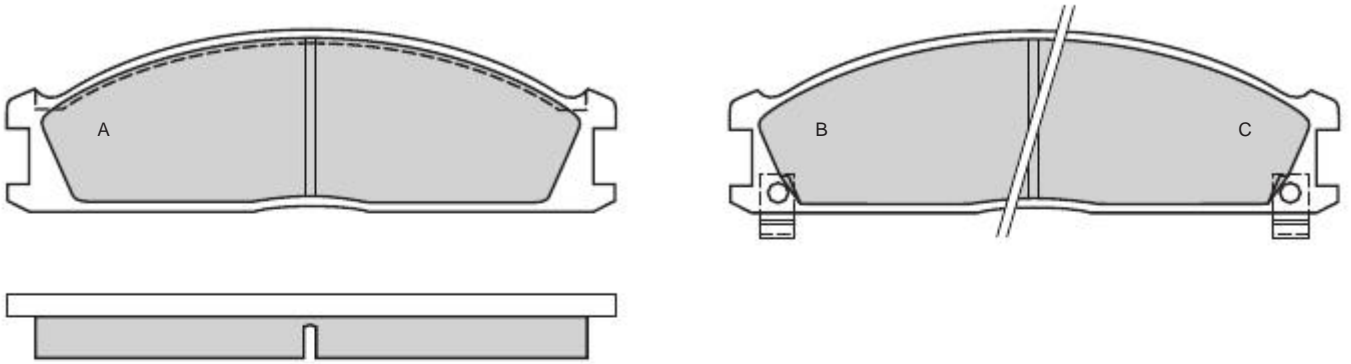



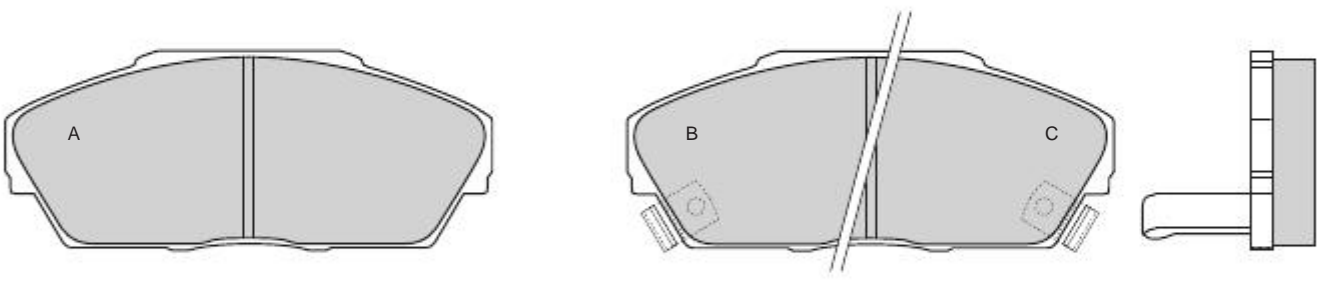



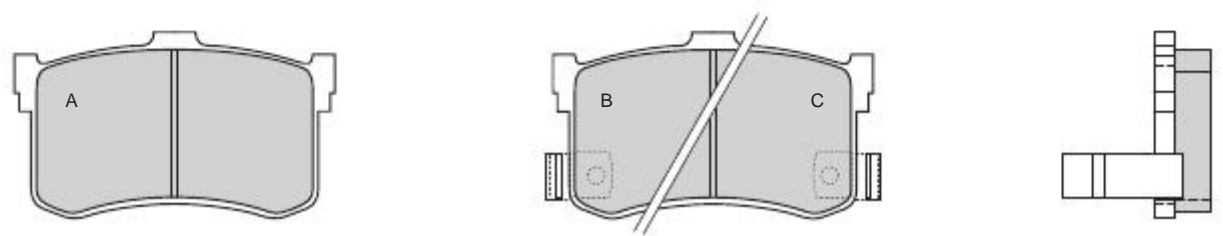

0371	HONDA - ROVER	AKEBONO	X	129,1	53	17	2A 1B-1C		
-------------	---------------	---------	---	-------	----	----	-------------	--	--



0372	HONDA - ROVER	AKEBONO	X	85,1	50	15	2A 1B-1C		
-------------	---------------	---------	---	------	----	----	-------------	--	--

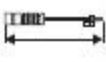

									
0373	ALFA ROMEO - FIAT - LANCIA	GIRLING	X	129,9	58,9	19,3	2A-2B	2	200

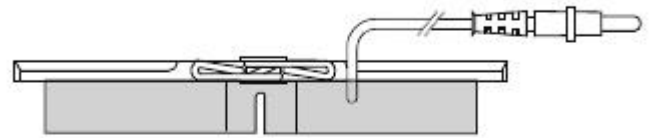
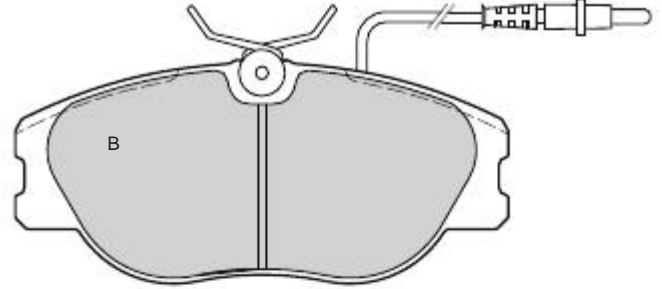
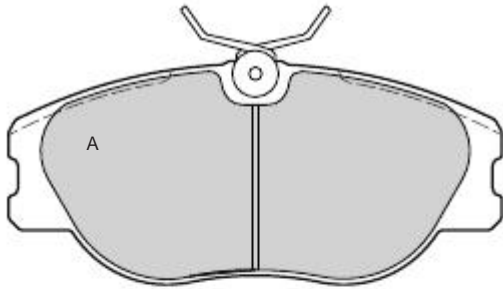



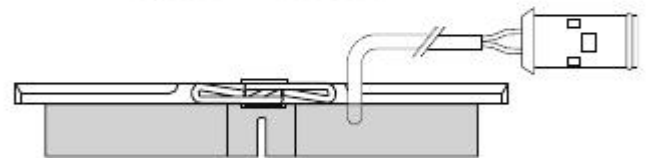
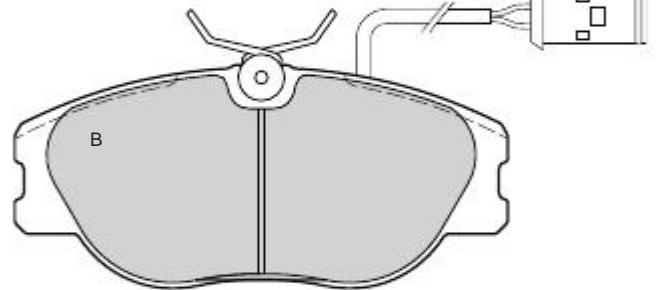
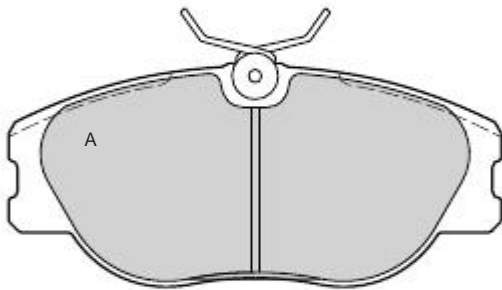



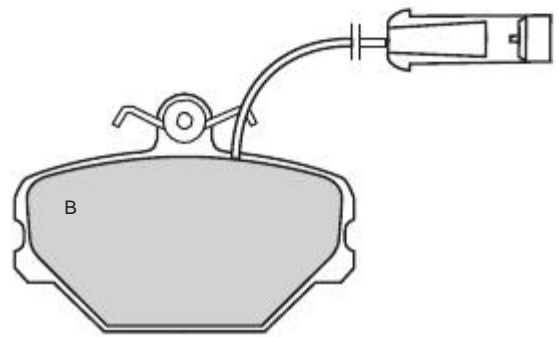
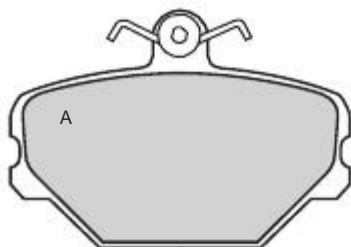



0374	ALFA ROMEO	GIRLING	X	129,9	58,9	19,3	2A-2B	2	460
-------------	------------	---------	---	-------	------	------	-------	---	-----



0375	FIAT	GIRLING	X	89,9	63,4	17	3A-1B	1	250
-------------	------	---------	---	------	------	----	-------	---	-----



									
0376	ALFA ROMEO	GIRLING	X	104,2	66,6	17	2A-2B	2	460

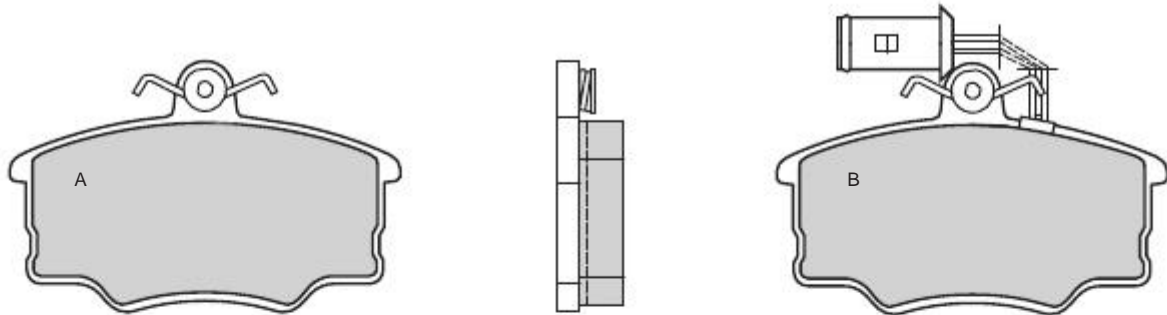



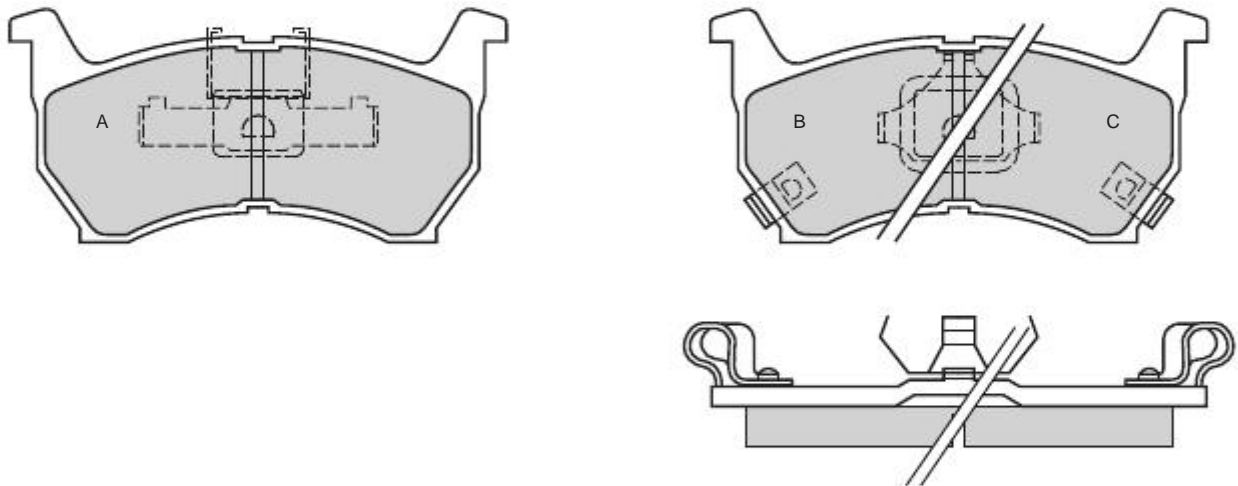



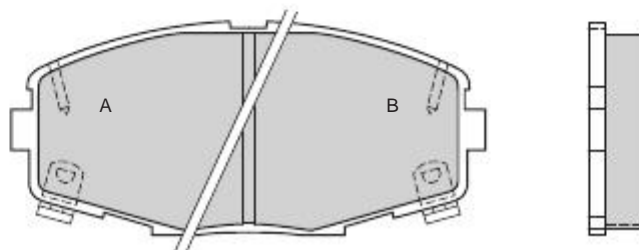

0377	MAZDA	AKEBONO	X	131,1	62,2	15	2A 1B-1C		
------	-------	---------	---	-------	------	----	-------------	--	--



0378	TOYOTA	AKEBONO	X	125,5	56	15,5	2A-2B		
------	--------	---------	---	-------	----	------	-------	--	--

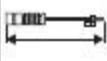

									
0379	PEUGEOT	GIRLING	X	95	49	18,5	2A-2B	2	220

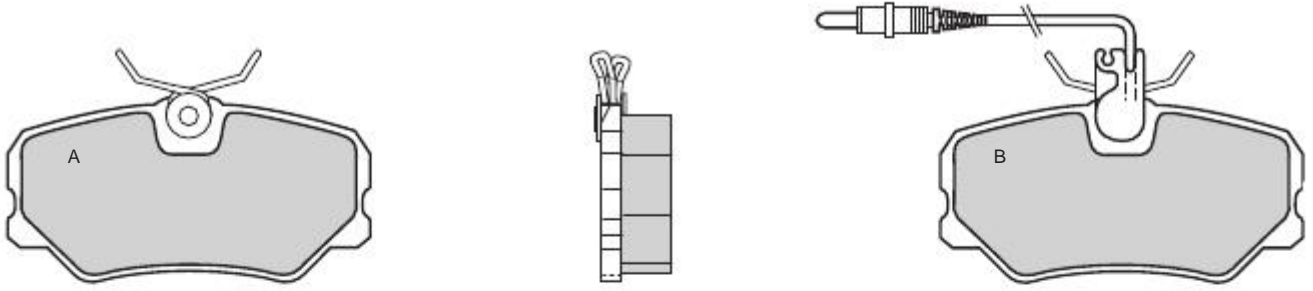



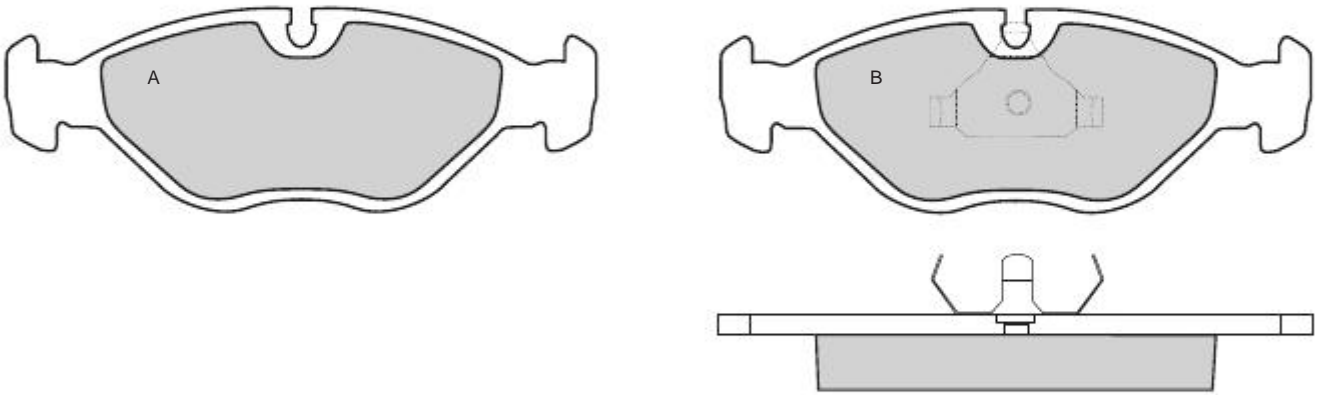



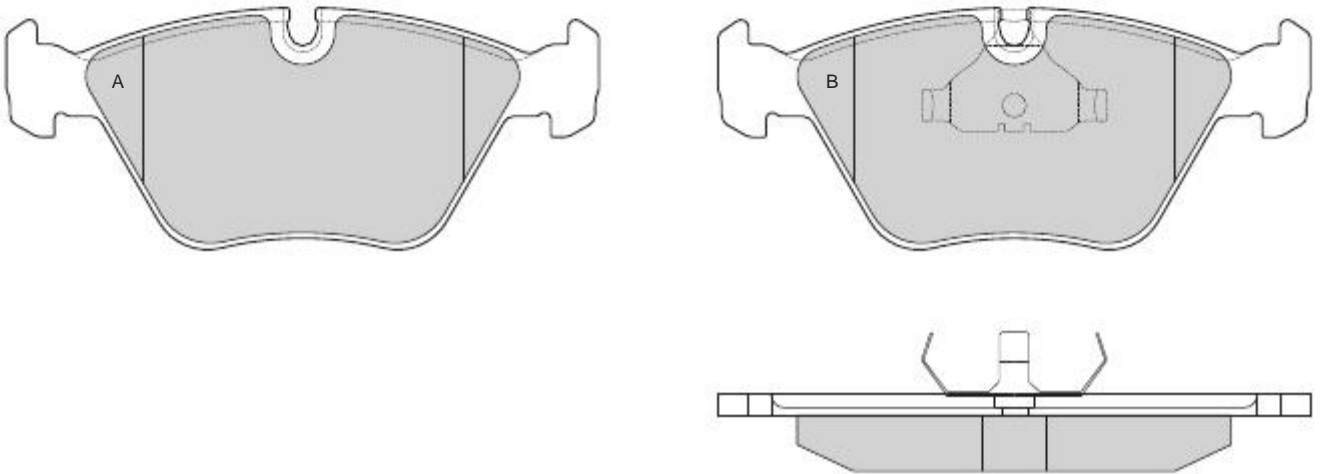

0380	SAAB	ATE	X	156,4	55,1	19,5	2A-2B		
------	------	-----	---	-------	------	------	-------	--	--



0381	BMW	ATE	X	156,4	64	20,3	2A-2B		
------	-----	-----	---	-------	----	------	-------	--	--

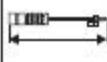

									
0382	AUDI	GIRLING	X	144,9	67,1	19	2A-2B	2	315

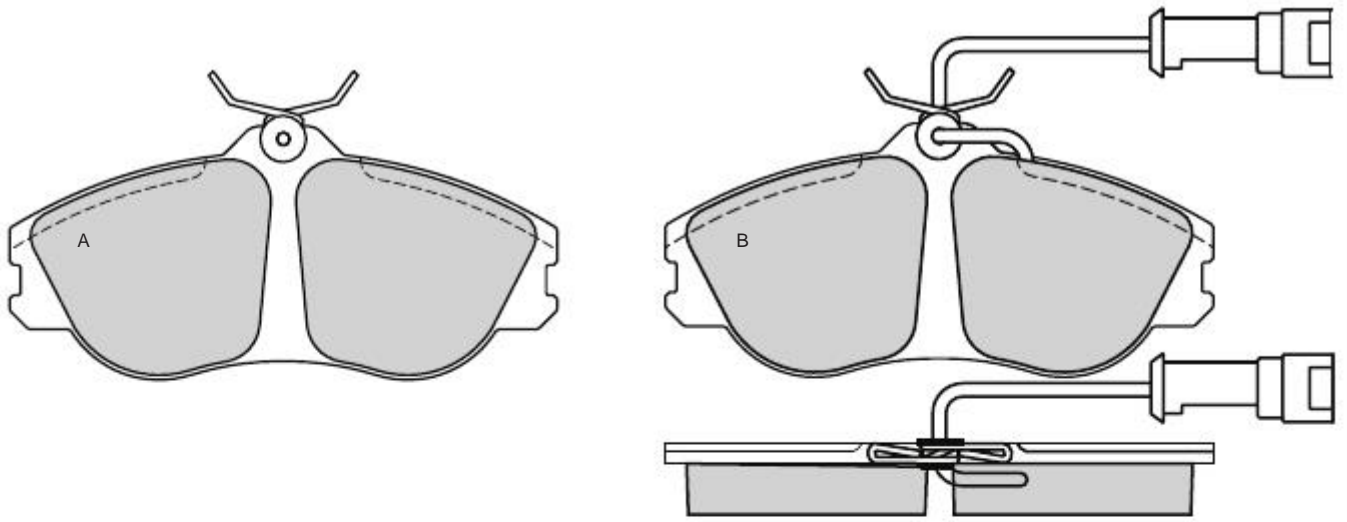



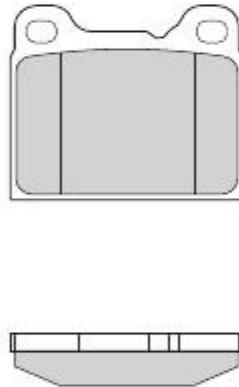



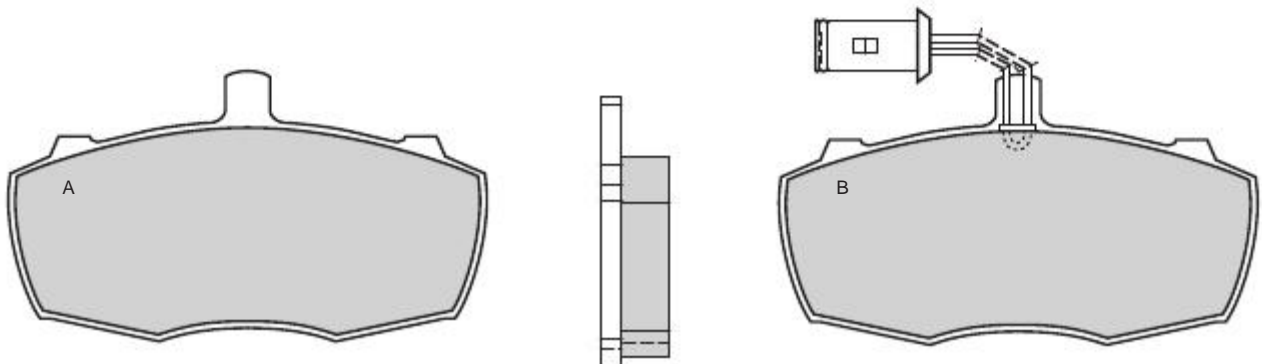

0383	VOLVO	ATE	X	61,4	56,25	15	4		
-------------	-------	-----	---	------	-------	----	---	--	--



0384	ROVER	LOCKHEED	X	126,7	72,7	18	2A-2B	2	225
-------------	-------	----------	---	-------	------	----	-------	---	-----

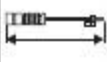

									
0385	ALFA ROMEO - LANCIA	GIRLING	X	109,9	58,7	19	2A-2B	2	220

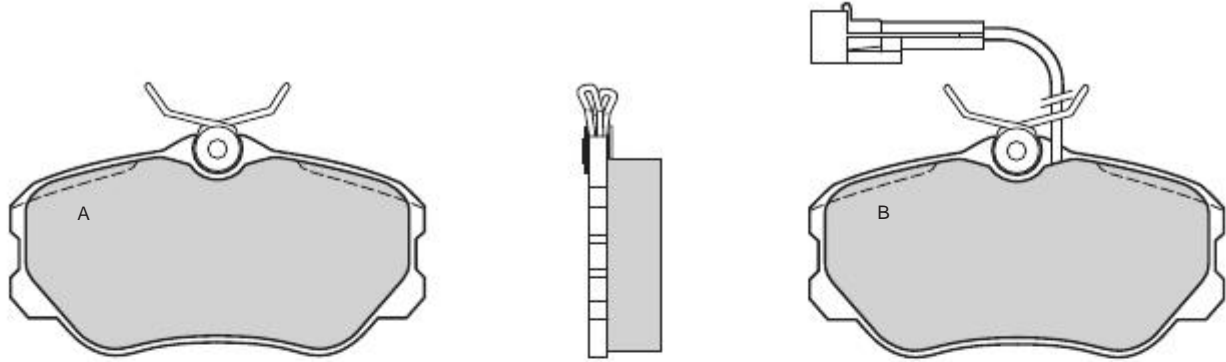



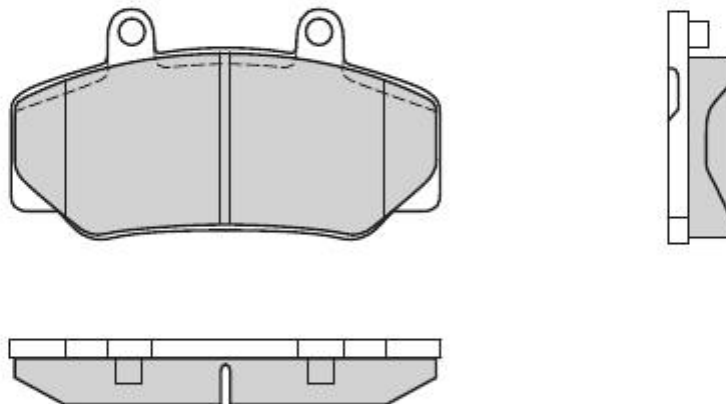



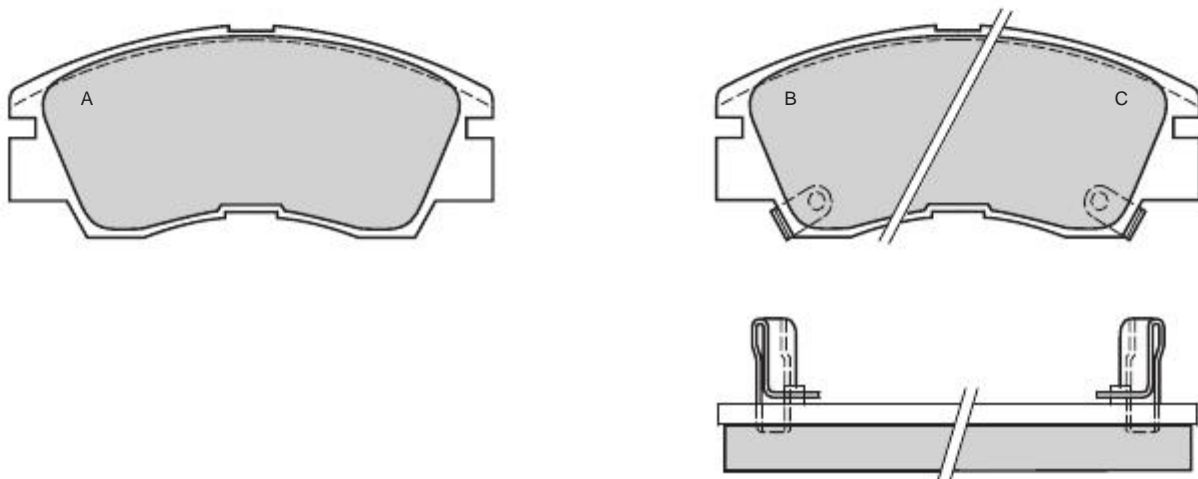



0386	VOLVO	BENDIX	X	113,95	62,3	17	4		
------	-------	--------	---	--------	------	----	---	--	--



0387	MITSUBISHI	AKEBONO	X	127,9	57	17	2A 1B-1C		
------	------------	---------	---	-------	----	----	-------------	--	--



									
0388	NISSAN	SUMITOMO	X	108,6	40,35	16	2A 1B-1C		

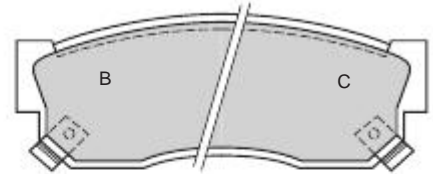
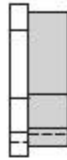



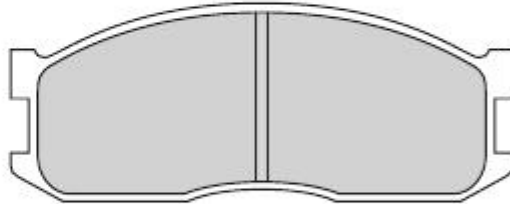



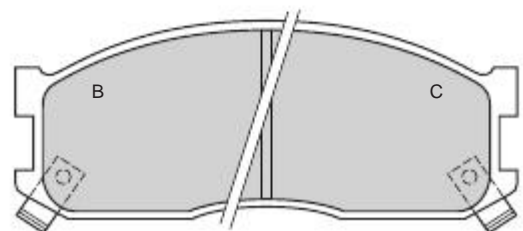
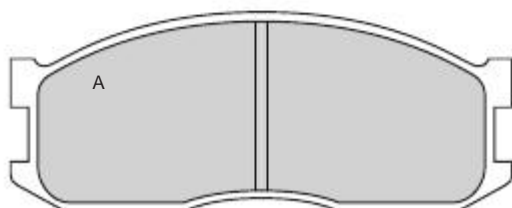

0389	FORD - MAZDA	AKEBONO	X	133,2	52,2	15,2	4		
-------------	--------------	---------	---	-------	------	------	---	--	--



0390	MAZDA - KIA	AKEBONO	X	133,2	52,2	15,2	2A 1B-1C		
-------------	-------------	---------	---	-------	------	------	-------------	--	--

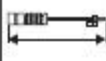

									
0391	HONDA	AKEBONO	X	127,5	54	17	4		

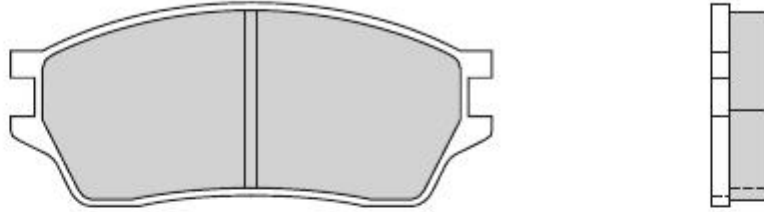



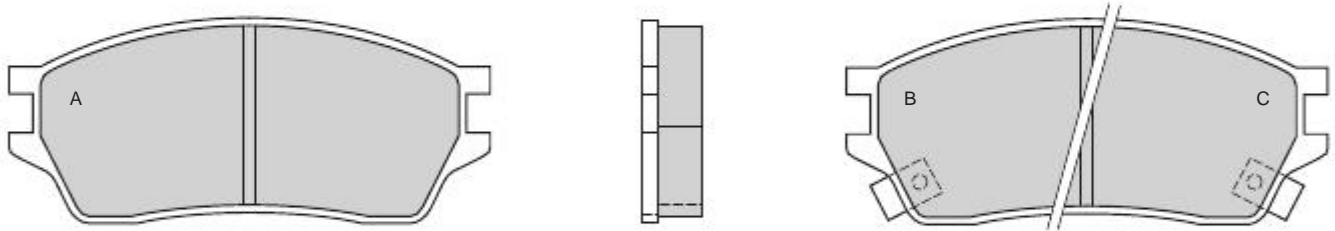



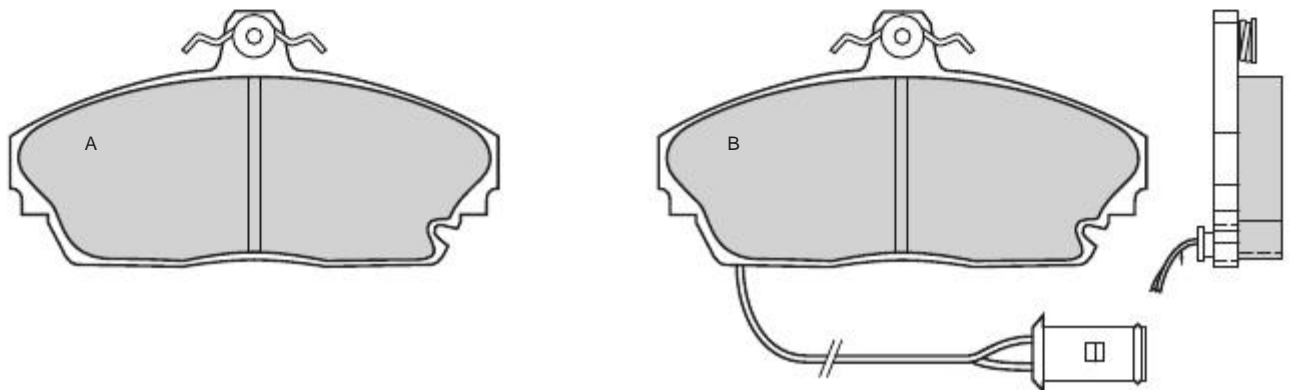

0392	HONDA	AKEBONO	X	127,5	54	17	2A 1B-1C		
-------------	-------	---------	---	-------	----	----	-------------	--	--



0393	HONDA - ROVER	GIRLING	X	129,25	67,9	17,5	3A-1B	1	225
-------------	---------------	---------	---	--------	------	------	-------	---	-----

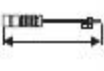

									
0394	HONDA - ROVER	GIRLING	X	129,9	72	17,5	3A-1B	1	225

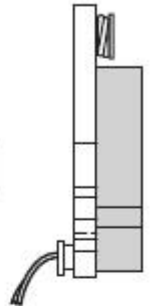
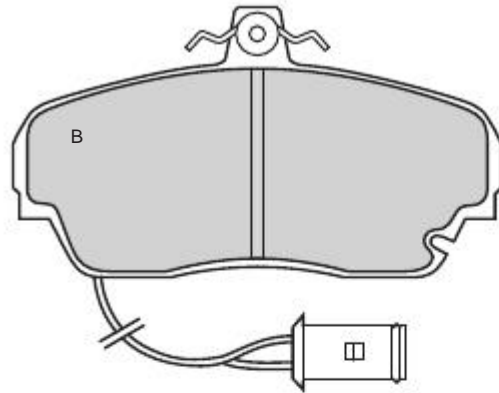
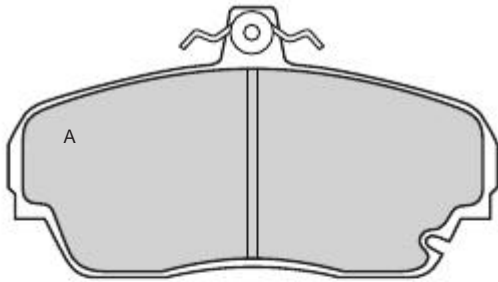



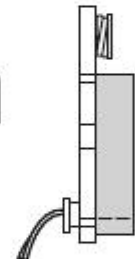
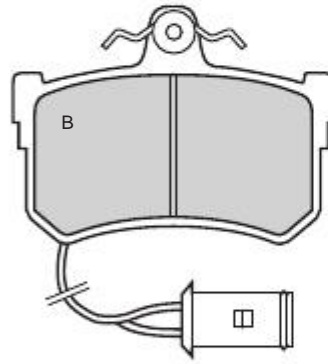
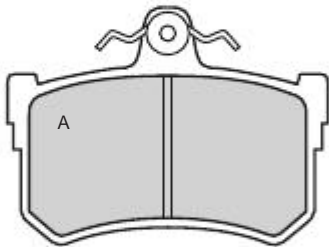



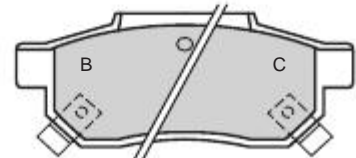
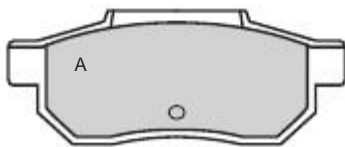

0395	HONDA - ROVER	GIRLING	X	85	62	14	3A-1B	1	225
-------------	---------------	---------	---	----	----	----	-------	---	-----



0396	HONDA	AKEBONO	X	89	35,5	13	2A 1B-1C		
-------------	-------	---------	---	----	------	----	-------------	--	--

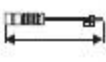

									
0397	HONDA	AKEBONO	X	89	35,2	13	2A 1B-1C		

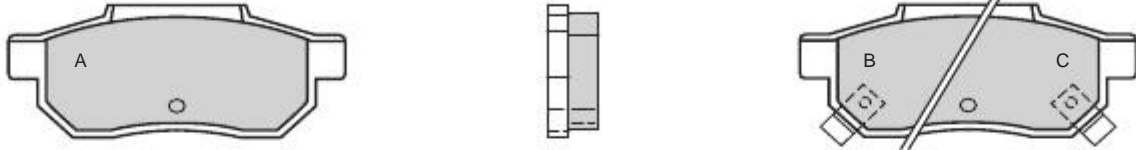



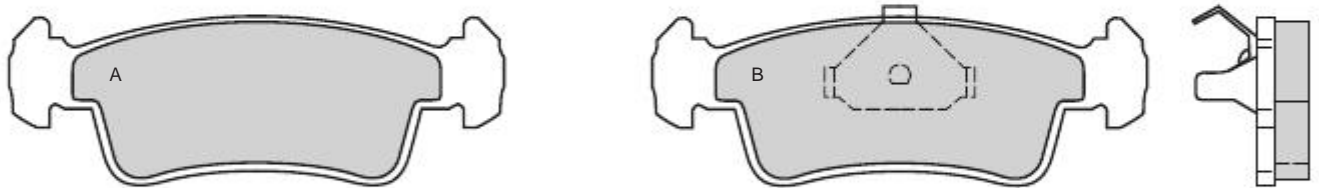







0398	SUZUKI	AKEBONO	X		131,3	45	15	2A-2B	
------	--------	---------	---	--	-------	----	----	-------	--



0399	FERRARI - PORSCHE	ATE	X	X	97,8	65,5	17,1	4	
------	-------------------	-----	---	---	------	------	------	---	--



									
0400	ISUZU - VAUXHALL	AKEBONO	X	120,9	48,2	15,3	2A-2B		

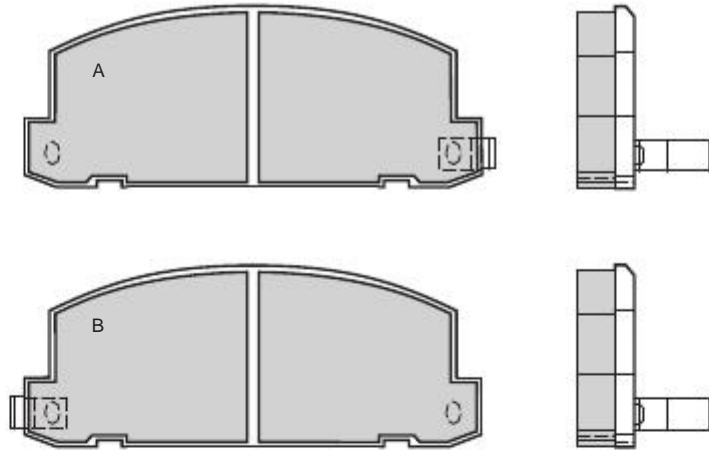

0401	LAND ROVER	LOCKHEED	X	126,8	68,55	18	4		
-------------	------------	----------	---	-------	-------	----	---	--	--

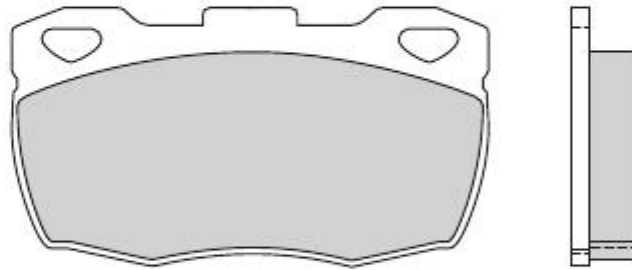

0402	LAND ROVER	LOCKHEED	X	104,9	72,3	18,5	4		
-------------	------------	----------	---	-------	------	------	---	--	--

