

0403	ISUZU	AKEBONO	X	111,4	46	13	2A-2B		

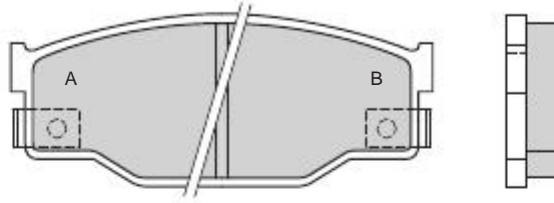

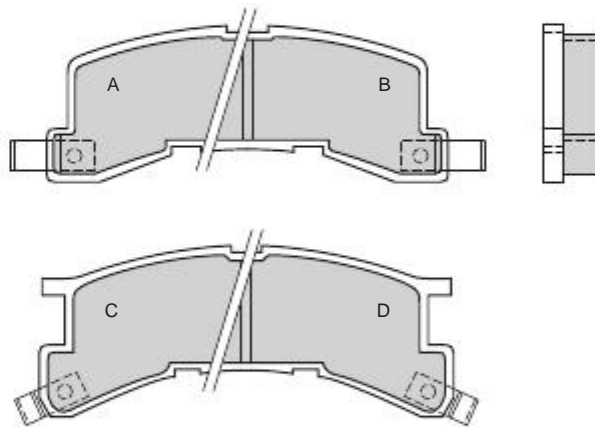

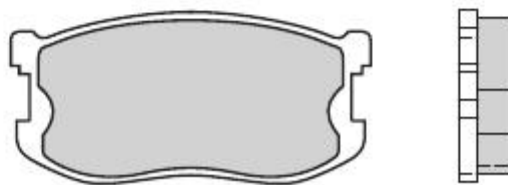





0404	ISUZU	AKEBONO	X	A/B 106,9 C/D 110,6	A/B 41 C/D 44,6	15	1A-1B 1C-1D		
-------------	-------	---------	---	------------------------	--------------------	----	----------------	--	--



0405	ISUZU	AKEBONO	X	95,1	45,6	14,5	4		
-------------	-------	---------	---	------	------	------	---	--	--

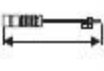

									
0406	HONDA	AKEBONO	X	127,7	48	15	2A 1B-1C		

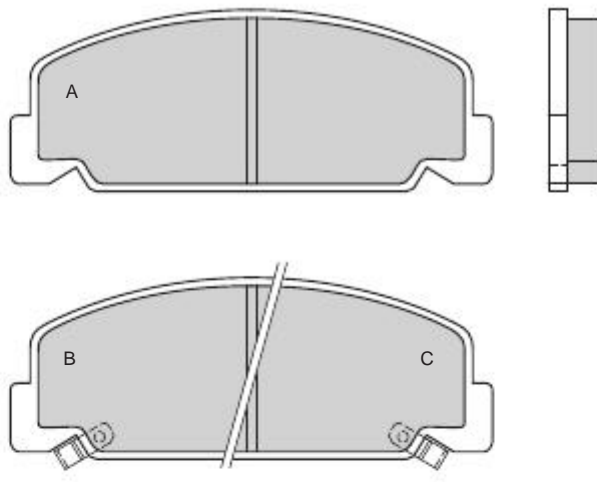



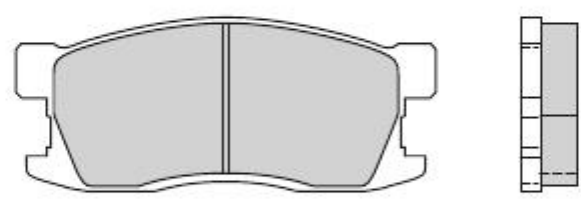



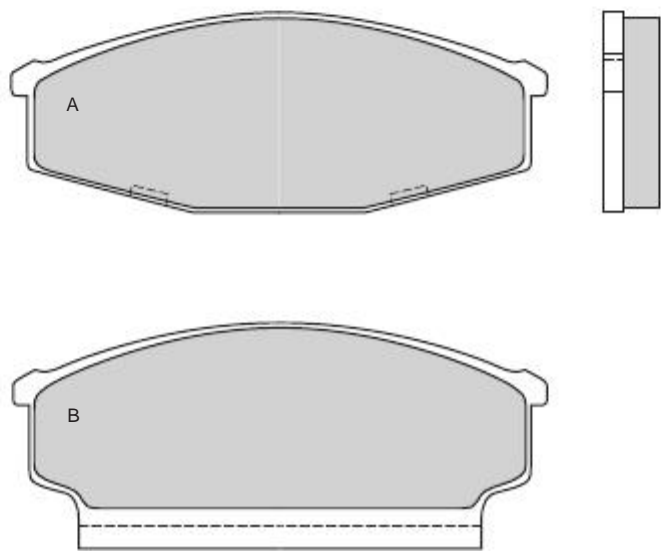



0407	HONDA	AKEBONO	X	111,3	47	15,5	4		
------	-------	---------	---	-------	----	------	---	--	--



0408	NISSAN	AKEBONO	X	A 141,9 B 142,1	A 53,4 B 58,5	15	2A-2B		
------	--------	---------	---	--------------------	------------------	----	-------	--	--



									
0409	MERCEDES	GIRLING	X	175,1	85,6	21,7	4	1	500

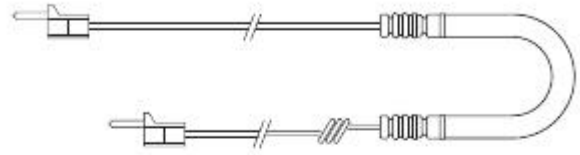
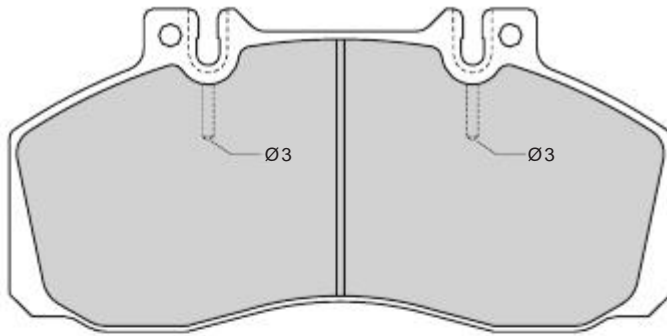

OPTIONAL



0410	MERCEDES	ATE	X	89,7	70,3	17,5	4	2	130
-------------	----------	-----	---	------	------	------	---	---	-----

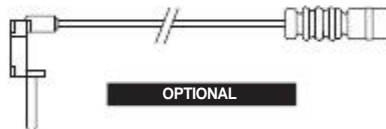
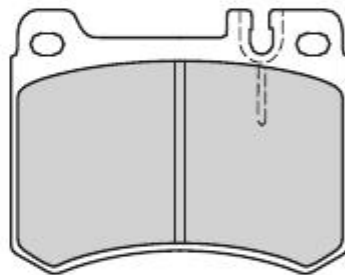





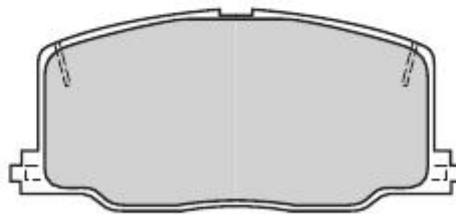





OPTIONAL

0411	TOYOTA	AKEBONO	X	119,8	53,9	15	4		
-------------	--------	---------	---	-------	------	----	---	--	--



OPTIONAL

									
0412	OPEL - VAUXHALL	DELCO	X	61,8	61	15	4		

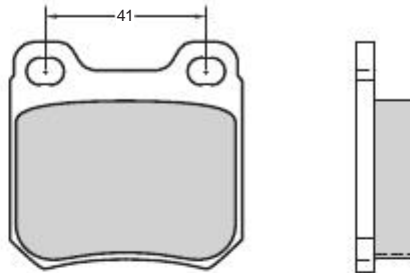



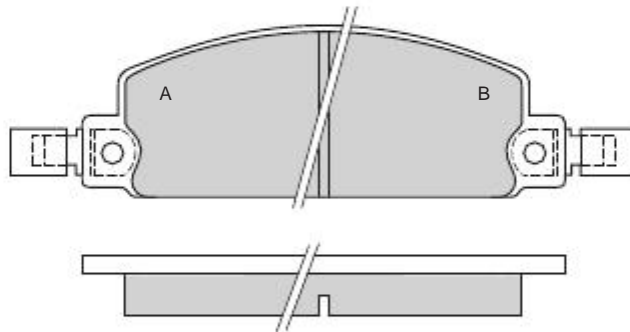



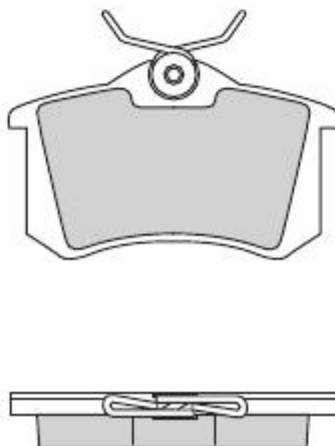

0413	ISUZU - VAUXHALL	AKEBONO	X	128,15	45	16	2A-2B		
-------------	------------------	---------	---	--------	----	----	-------	--	--



0414	PEUGEOT - SEAT VOLKSWAGEN	GIRLING	X	87	52,9	15	4		
-------------	------------------------------	---------	---	----	------	----	---	--	--

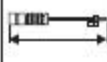

									
0415	BMW	ATE	X	123,1	44,4	17	2A-2B	2	810

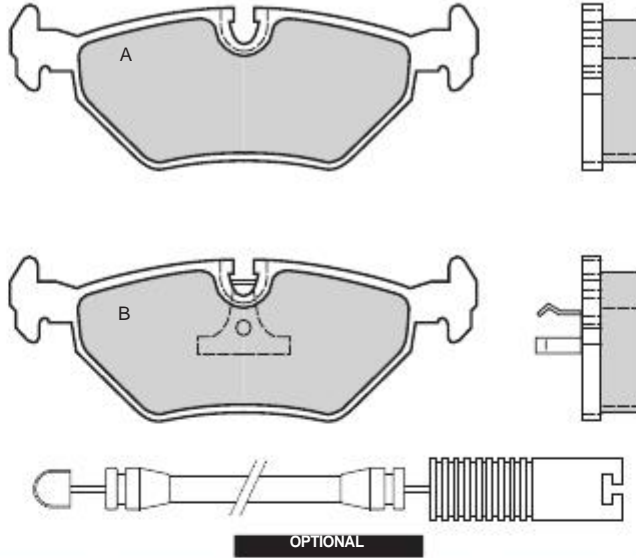



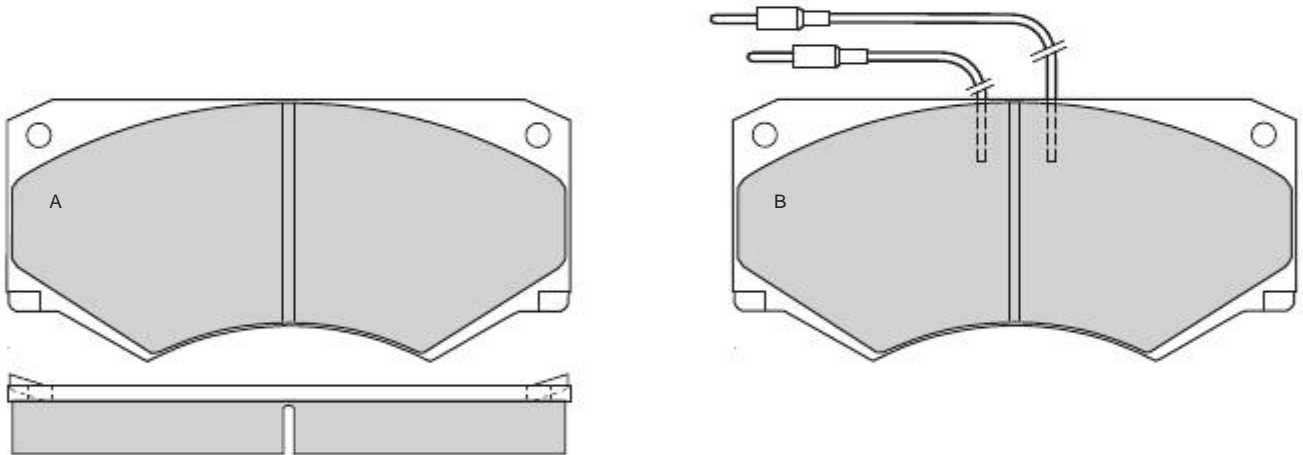



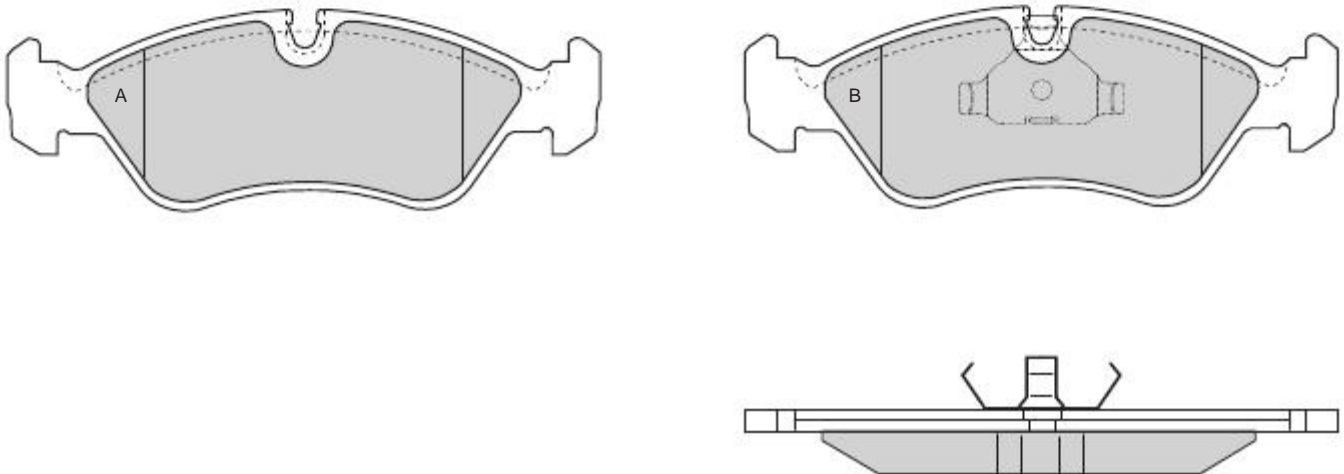

0416	FIAT	PERROT	X	149	69	18	2A-2B	2	140 200
------	------	--------	---	-----	----	----	-------	---	------------



0417	DAEWOO - OPEL VAUXHALL	ATE	X	156,4	52,8	17	2A-2B		
------	---------------------------	-----	---	-------	------	----	-------	--	--

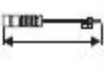

									
0418	OPEL - SAAB VAUXHALL	ATE	X	61,6	57,35	15,5	4		

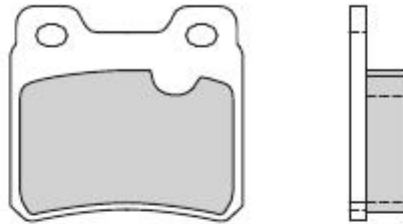



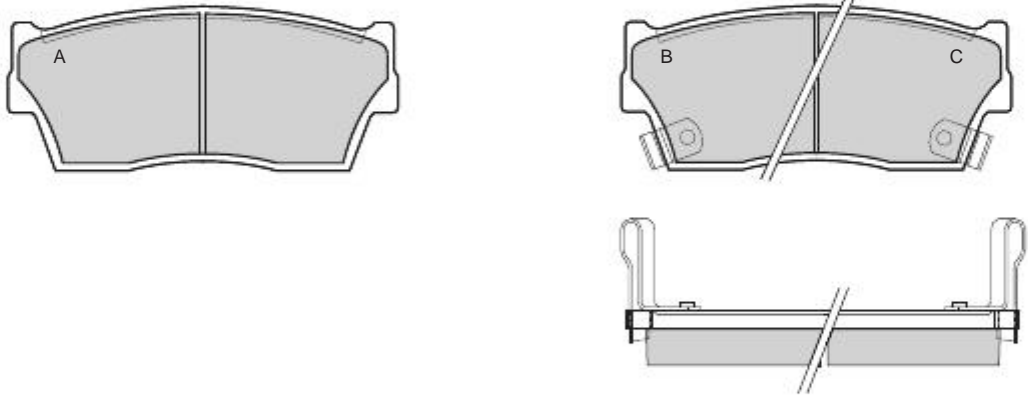



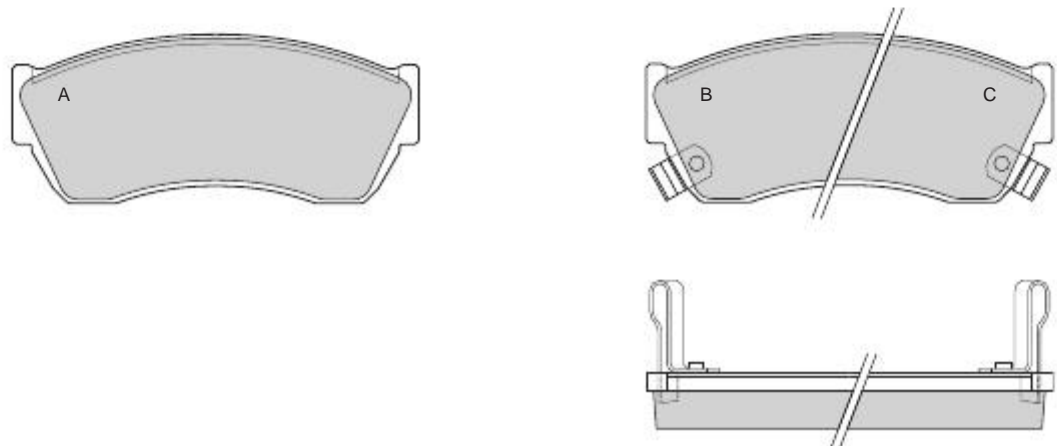



0419	SUZUKI	AKEBONO	X	103,4	43,6	15	2A 1B-1C		
-------------	--------	---------	---	-------	------	----	-------------	--	--



0420	SUBARU - SUZUKI - TATA	SUMITOMO	X	107,3	44,6	15	2A 1B-1C		
-------------	------------------------	----------	---	-------	------	----	-------------	--	--



									
0421	MAZDA	SUMITOMO	X	116,3	54,55	15	4		

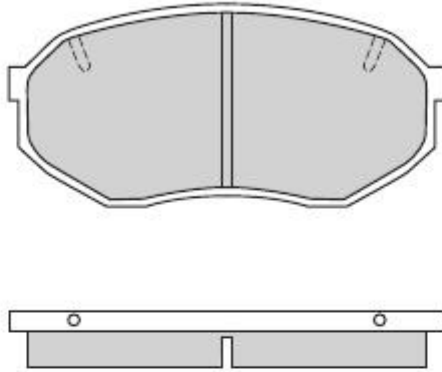



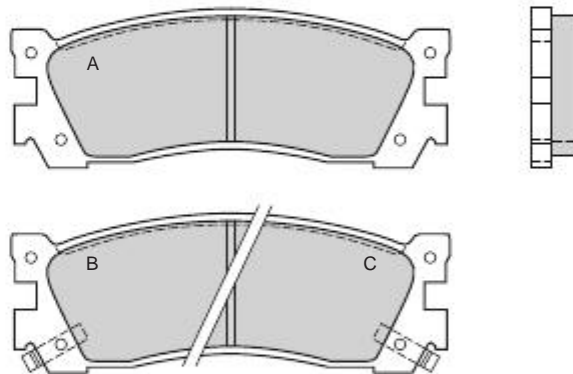



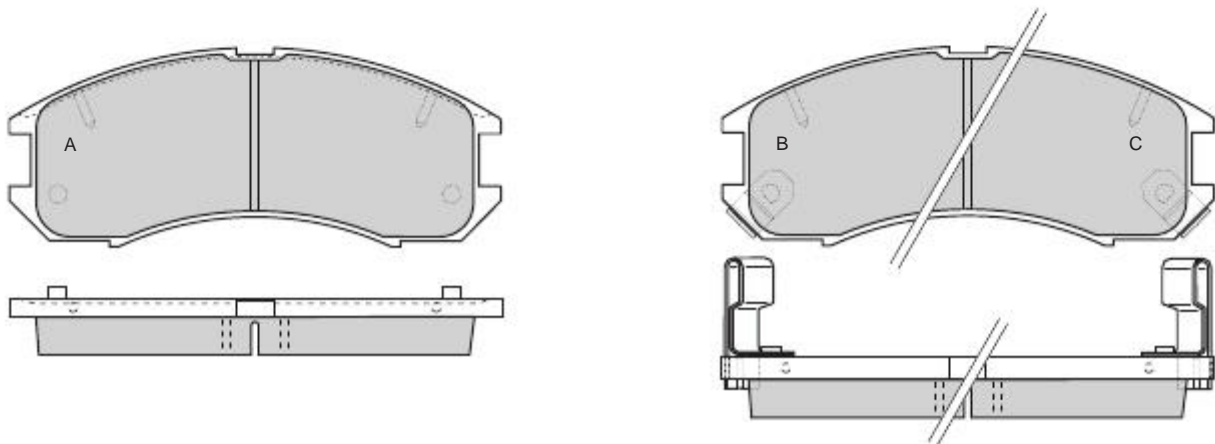

0422	MAZDA	AKEBONO	X	117	42,7	13	2A 1B-1C		
-------------	-------	---------	---	-----	------	----	-------------	--	--



0423	FORD - MAZDA	AKEBONO	X	129,9	52,45	A 15 B 16	2A 1B-1C		
-------------	--------------	---------	---	-------	-------	--------------	-------------	--	--

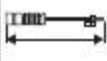

									
0424	FORD - MAZDA	SUMITOMO	X	104	42,2	13	4		

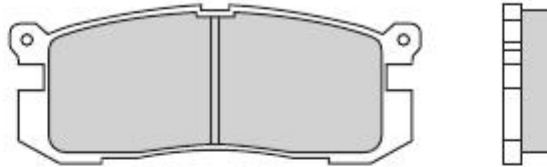



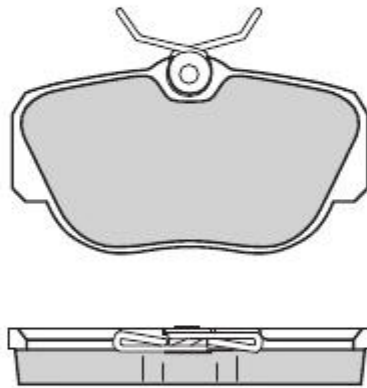



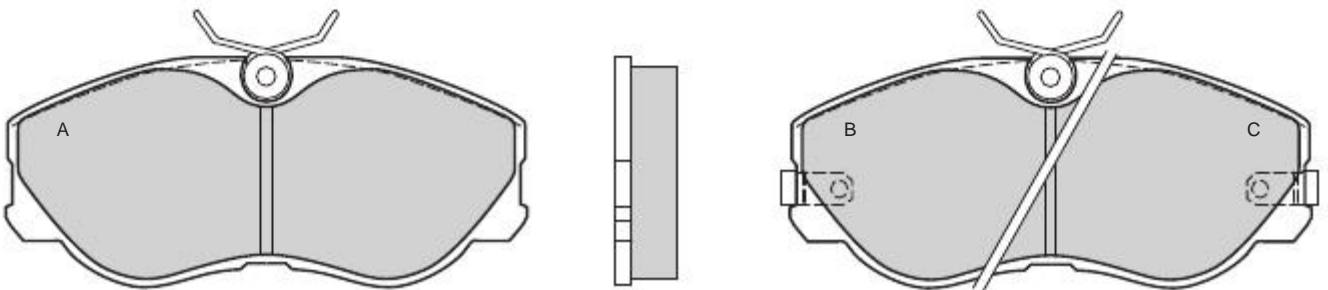

0425	MERCEDES	GIRLING	X	95	52,85	17,9	4		
------	----------	---------	---	----	-------	------	---	--	--



0426	NISSAN	SUMITOMO	X	137	60,6	17	2A 1B-1C		
------	--------	----------	---	-----	------	----	-------------	--	--

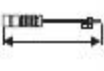

									
0427	FORD	ATE	X	141,4	44,7	18	2A-2B		

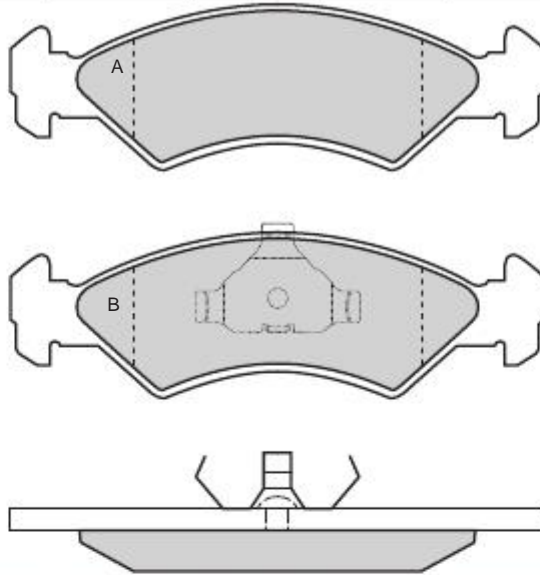



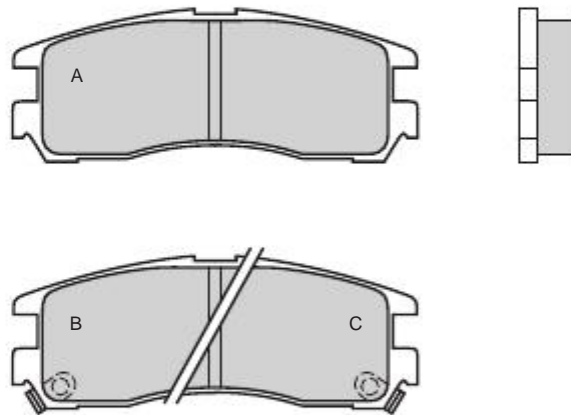



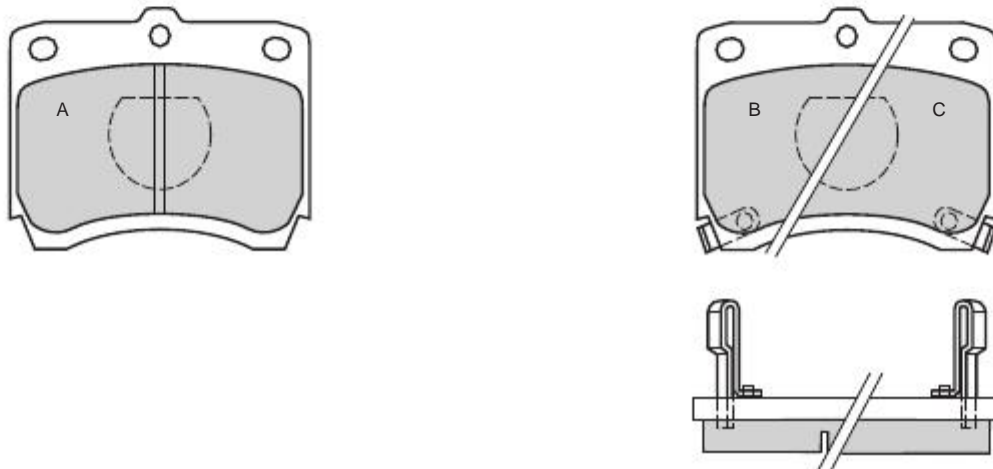



0428	MITSUBISHI	AKEBONO	X	107,8	41,1	15,5	2A 1B-1C		
------	------------	---------	---	-------	------	------	-------------	--	--



0429	MAZDA - KIA	SUMITOMO	X	78,8	63,5	14,2	2A 1B-1C		
------	-------------	----------	---	------	------	------	-------------	--	--



									
0430	CITROEN	BENDIX	X	130,85	70	16,8	2A-2B	2	130 338

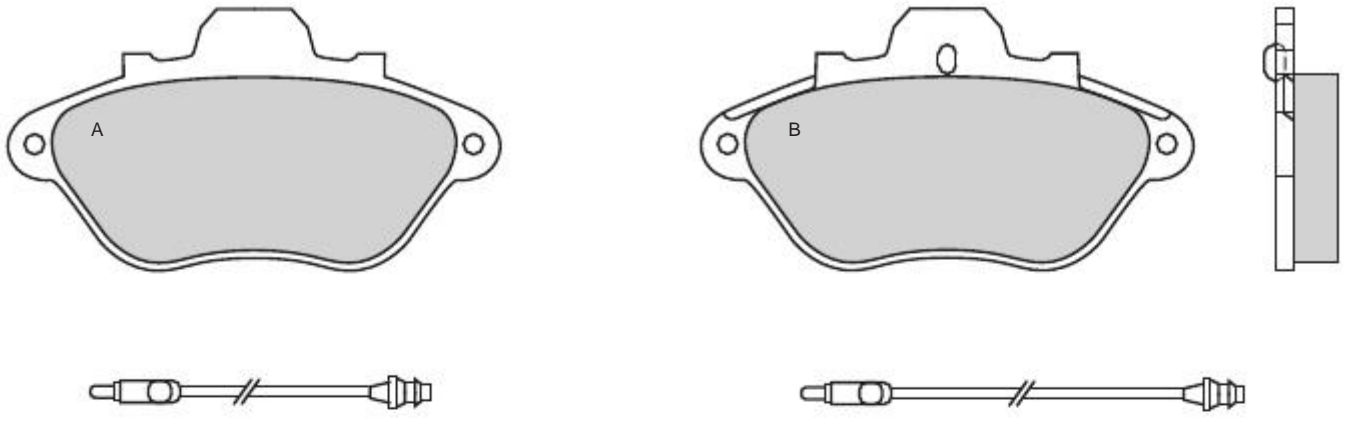



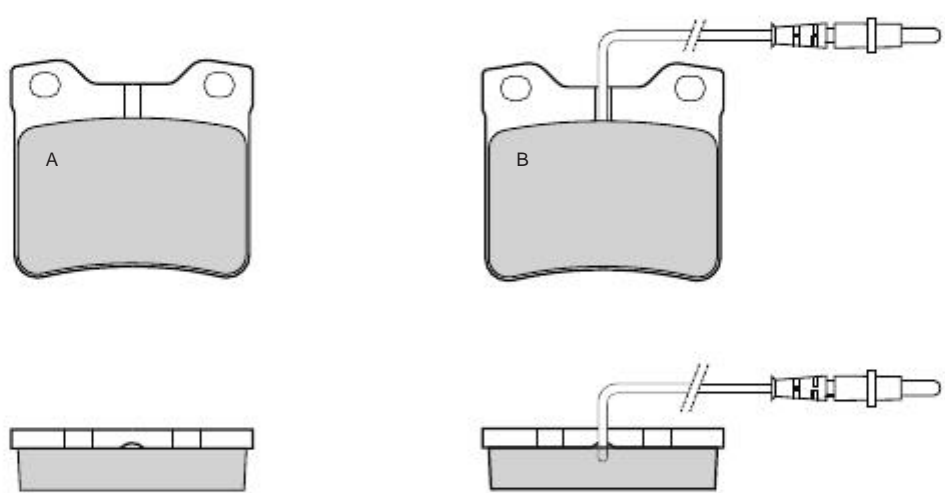



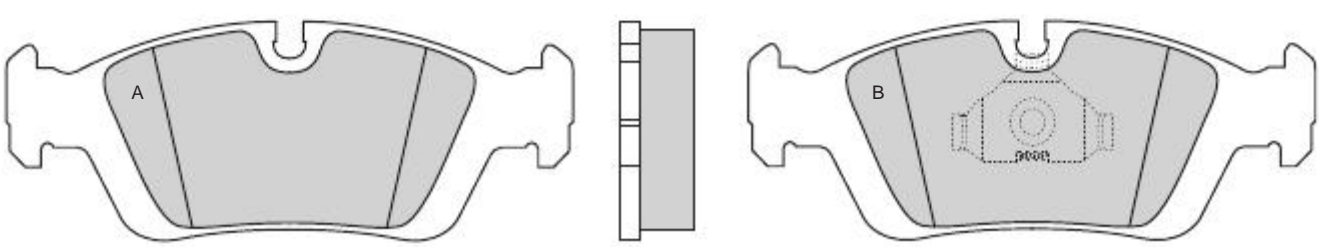

0431	PEUGEOT	ATE	X	63,7	57,4	16	2A-2B	2	140
-------------	----------------	------------	----------	-------------	-------------	-----------	--------------	----------	------------



0432	BMW	ATE	X	151,4	57,5	17	2A-2B		
-------------	------------	------------	----------	--------------	-------------	-----------	--------------	--	--

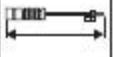

									
0433	JAGUAR - MERCEDES	GIRLING	X	114,95	80,25	17,5	2A-2B	2	225

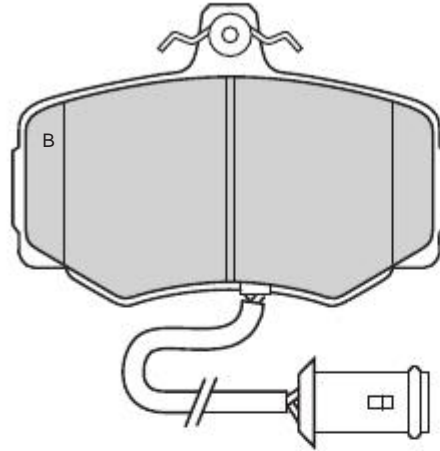
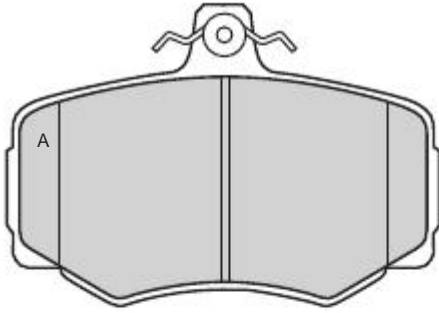



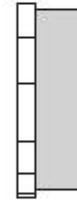
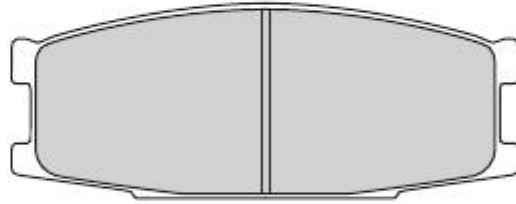



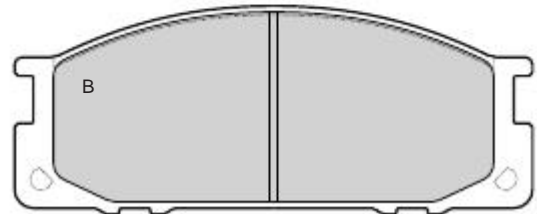
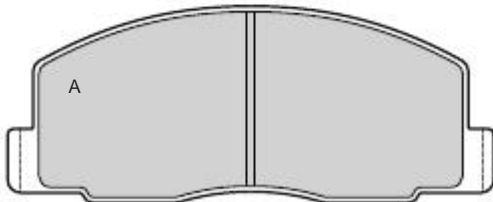

0434	MITSUBISHI	SUMITOMO	X	133,1	53	17,5	4		
-------------	------------	----------	---	-------	----	------	---	--	--



0435	TOYOTA	AKEBONO	X	A 128,4 B 137	A 52 B 55	15,5	2A-2B		
-------------	--------	---------	---	------------------	--------------	------	-------	--	--

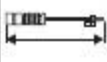

									
0436	ISUZU	AKEBONO	X	131	40	13	1A-1B 1C-1D		

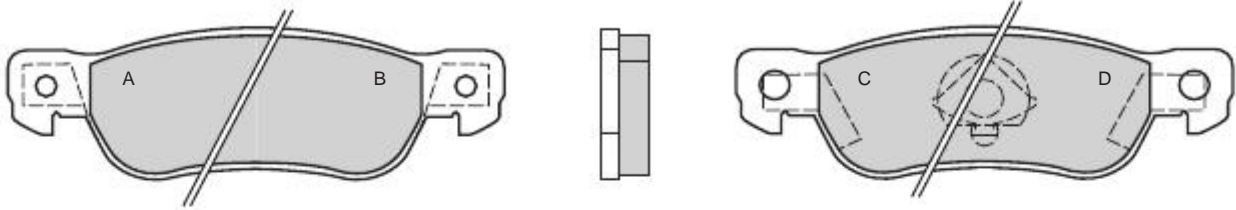



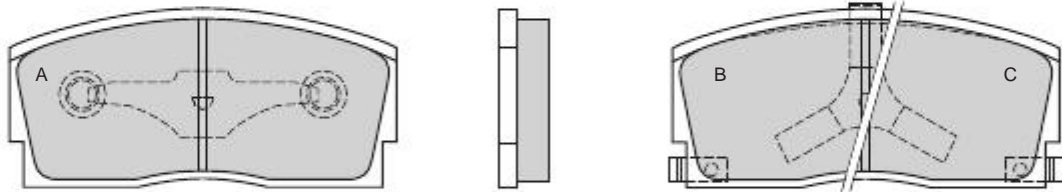



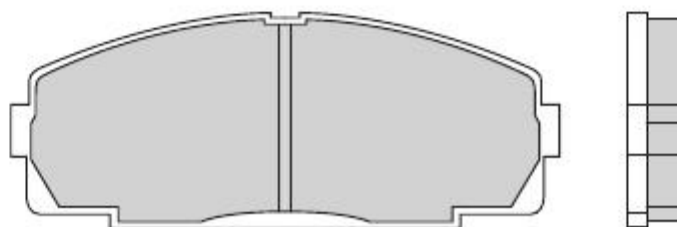

0437	DAIHATSU	SUMITOMO	X	102,8	47,3	14	2A 1B-1C		
-------------	----------	----------	---	-------	------	----	-------------	--	--



0438	TOYOTA	SUMITOMO	X	145,4	56,9	15,5	4		
-------------	--------	----------	---	-------	------	------	---	--	--

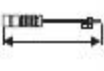

									
0439	HYUNDAI - NISSAN	SUMITOMO	X	137	54,6	17	2A 1B-1C		

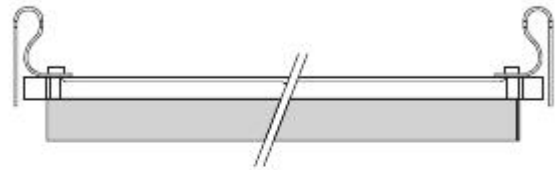
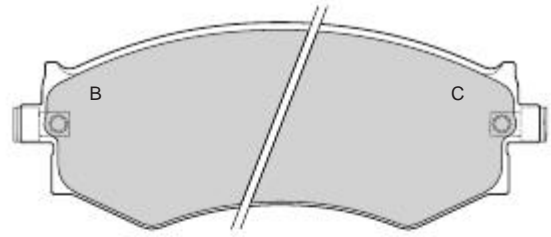
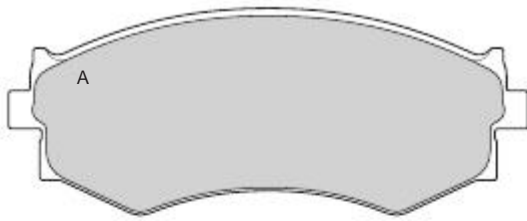







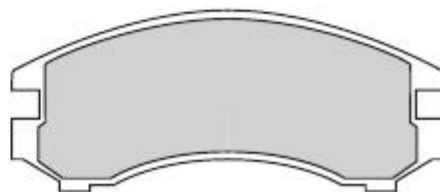

0440	NISSAN	SUMITOMO	X	98,6	33,8	14	4		
-------------	--------	----------	---	------	------	----	---	--	--



0441	NISSAN	SUMITOMO	X	114,9	47,6	16	4		
-------------	--------	----------	---	-------	------	----	---	--	--

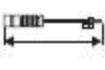

									
0442	NISSAN	SUMITOMO	X	98,95	36,1	14	2A 1B-1C		

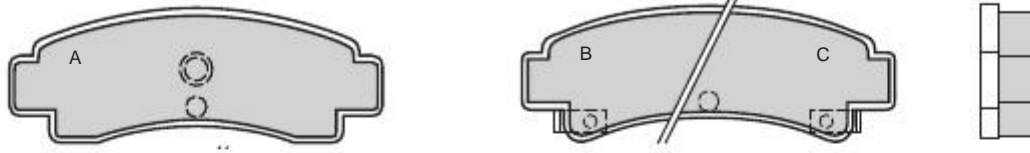



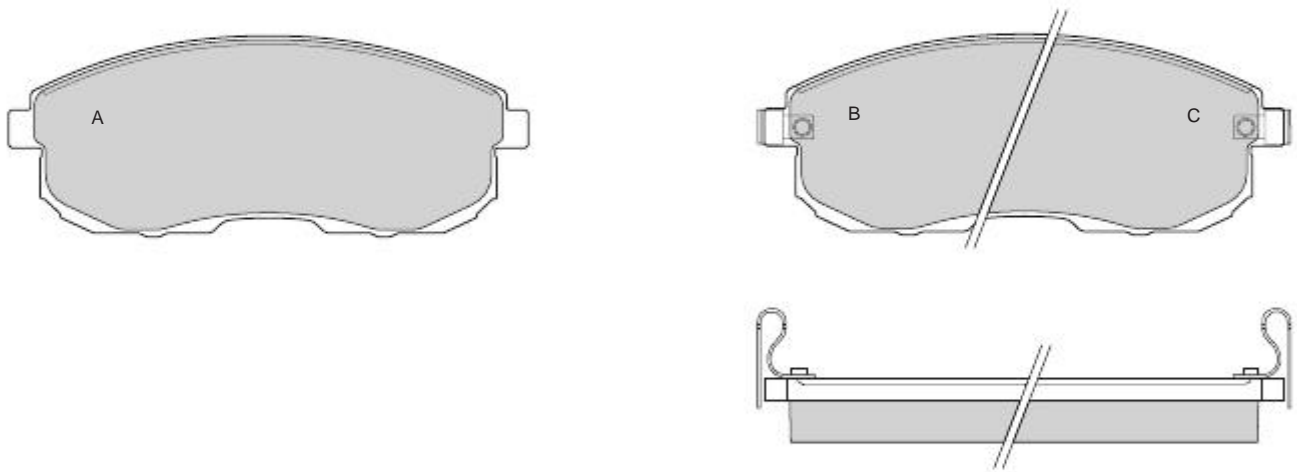



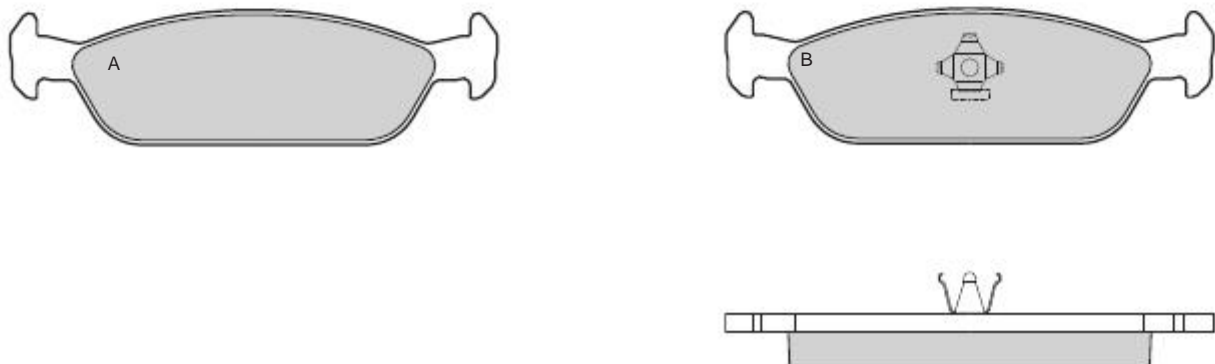



0443	NISSAN	SUMITOMO	X	137,1	53,1	17	2A 1B-1C		
-------------	--------	----------	---	-------	------	----	-------------	--	--



0444	DAIHATSU	AKEBONO	X	128,6	35,6	14	2A-2B		
-------------	----------	---------	---	-------	------	----	-------	--	--



									
0445	NISSAN	AKEBONO	X	127,8	50,5	19	4		

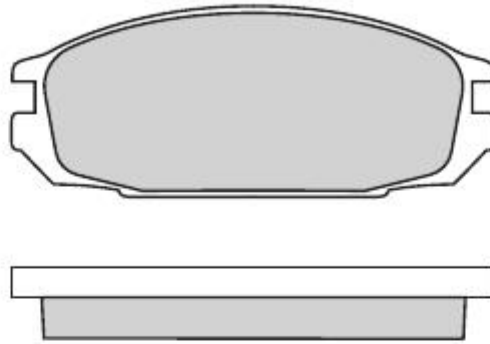



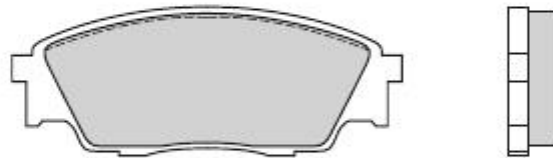



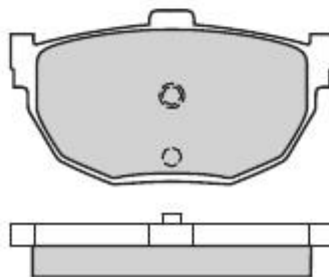



0446	SUBARU	AKEBONO	X	103,2	39	14	4		
-------------	--------	---------	---	-------	----	----	---	--	--



0447	NISSAN	SUMITOMO	X	85,4	45,9	14	4		
-------------	--------	----------	---	------	------	----	---	--	--



									
0448	MAZDA	AKEBONO	X	107,7	39,4	13	4		

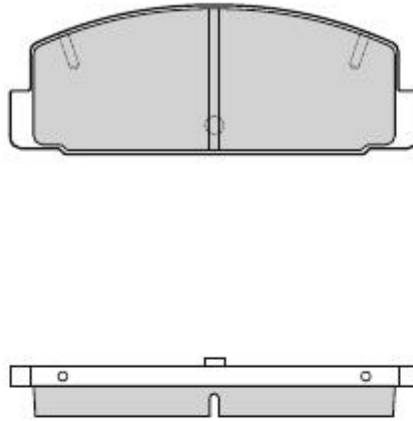



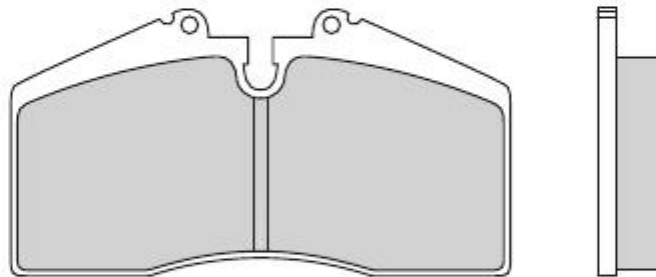



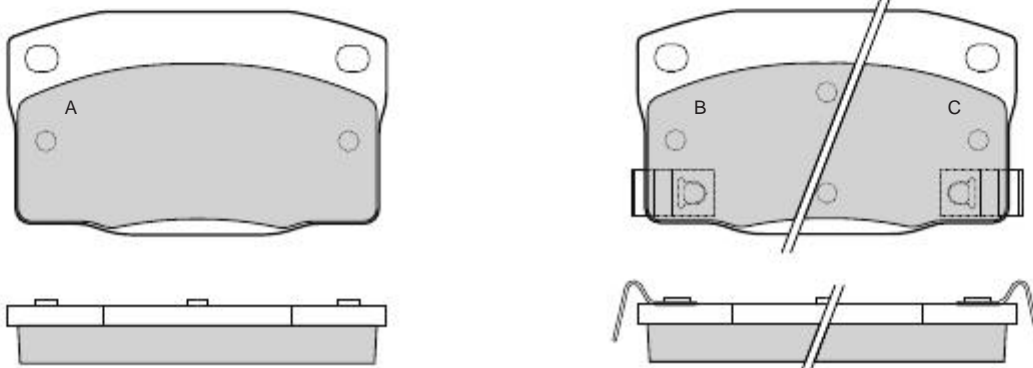

0449	PORSCHE	ATE	X	X	131,8	71	17,3	4	
------	---------	-----	---	---	-------	----	------	---	--



0450	OPEL - DAEWOO	DELCO	X		100	59	15	2A 1B-1C	
------	---------------	-------	---	--	-----	----	----	-------------	--

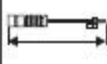

									
0451	BMW	GIRLING	X	94,8	52,1	17	4		

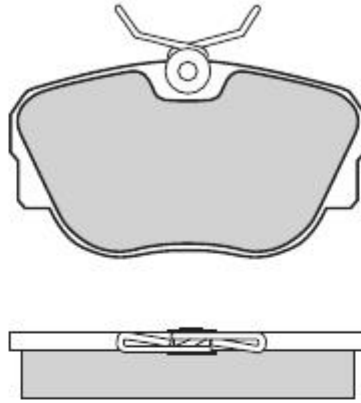



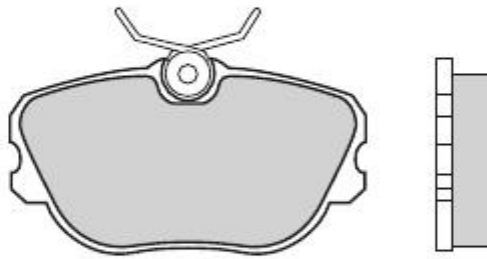



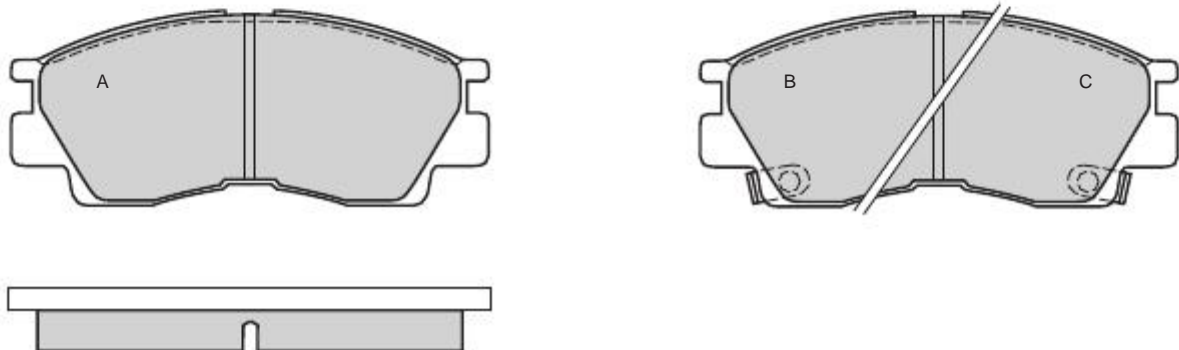

0452	VOLVO	GIRLING	X	95	52,1	15,8	4		
-------------	-------	---------	---	----	------	------	---	--	--



0453	MITSUBISHI	SUMITOMO	X	127,9	52,1	16,7	2A 1B-1C		
-------------	------------	----------	---	-------	------	------	-------------	--	--

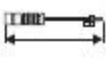

									
0454	JAGUAR	GIRLING	X	90	53	12,8	2A-2B	2	430

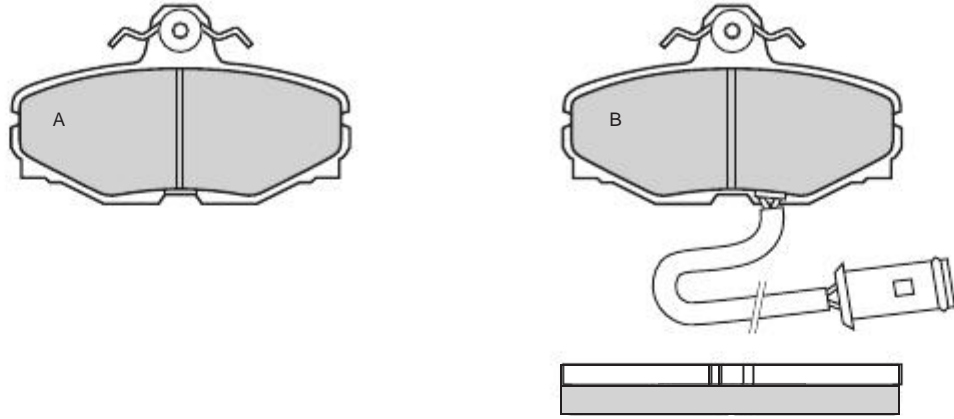



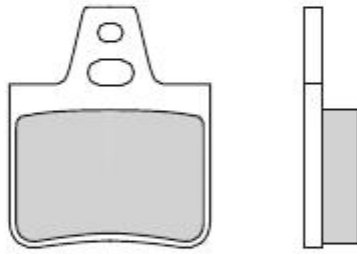



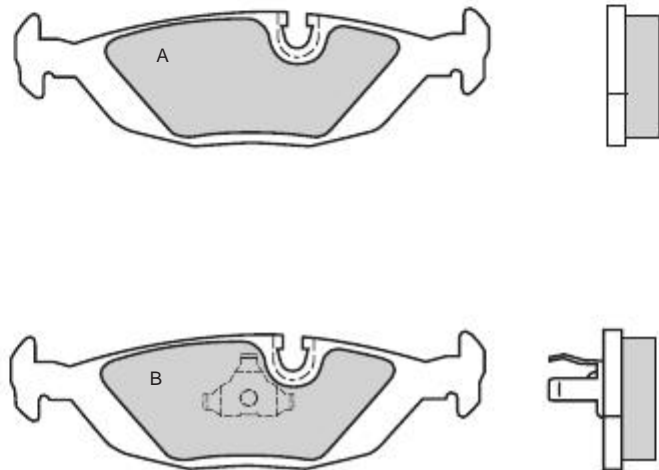



0455	CITROEN	CITROEN	X	54	65	15	4		
------	---------	---------	---	----	----	----	---	--	--



0456	SAAB - VOLVO	ATE	X	125,1	36,5	14,7	2A-2B		
------	--------------	-----	---	-------	------	------	-------	--	--



									
0457	LADA		X	93,2	51	16	2A-2B		

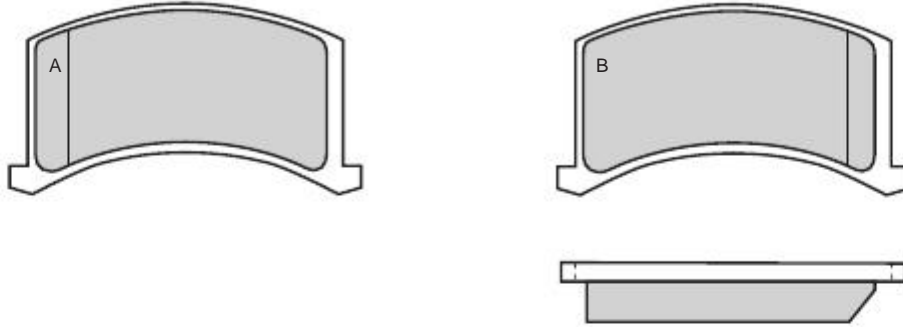



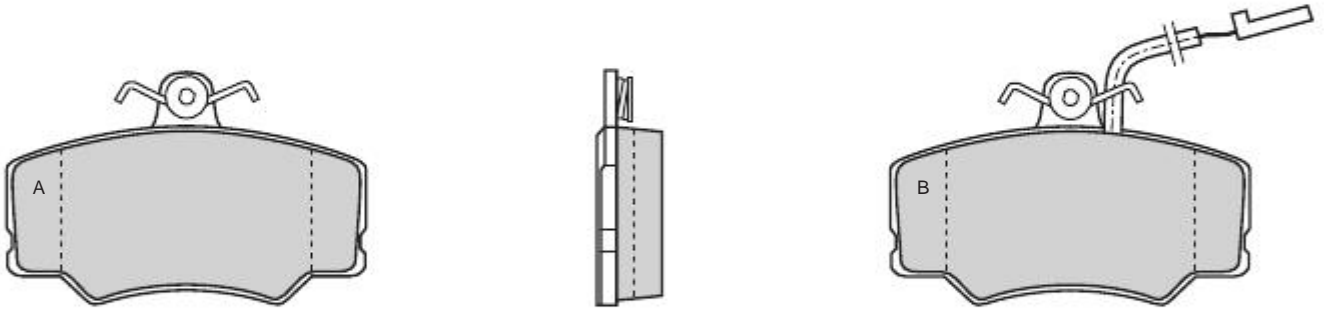



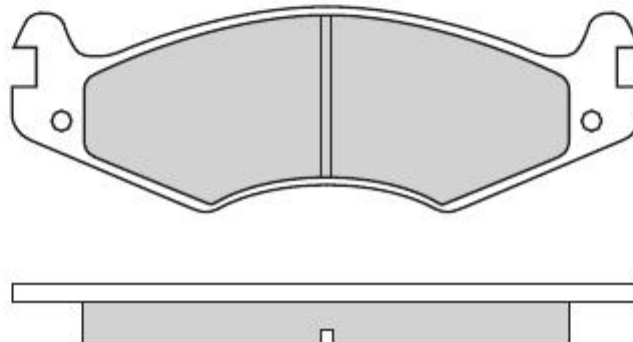



0458	ALFA ROMEO	GIRLING	X	94,9	61,9	17	2A-2B	2	900
-------------	------------	---------	---	------	------	----	-------	---	-----



0459	RENAULT - JEEP	BREMBO	X	166,9	52,75	17	4		
-------------	----------------	--------	---	-------	-------	----	---	--	--



									
0460	FORD	ATE	X	89,6	70,6	15,8	2A-2B	2	255

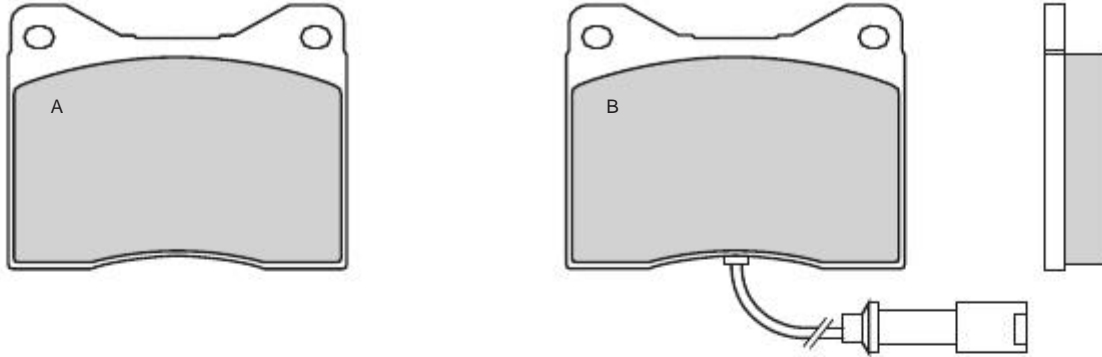



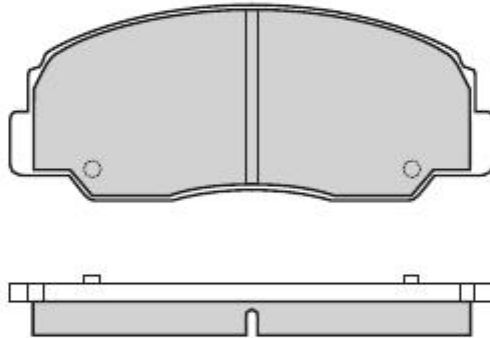



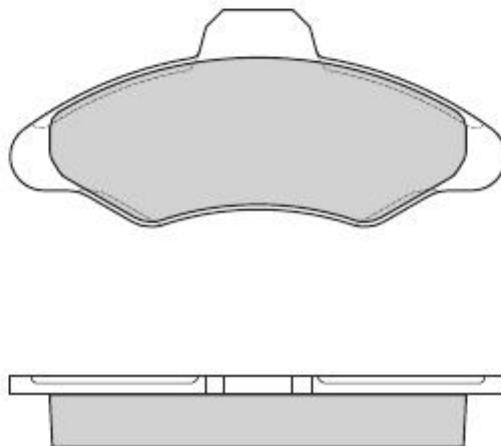

0461	DAIHATSU	AKEBONO	X	127,9	52,2	13	4		
-------------	----------	---------	---	-------	------	----	---	--	--



0462	FORD	BENDIX	X	130,9	57,7	18,3	4		
-------------	------	--------	---	-------	------	------	---	--	--

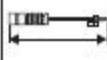

									
0463	TOYOTA - VOLKSWAGEN	SUMITOMO	X	119,3	73,6	15	2A 1B-1C		

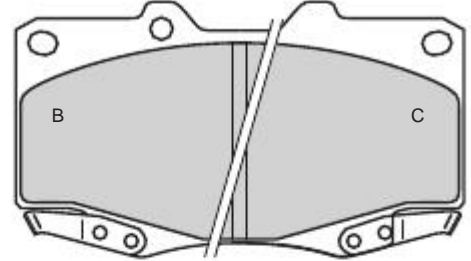
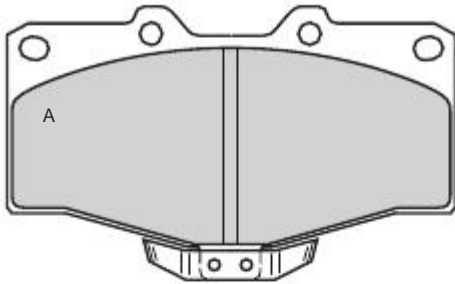



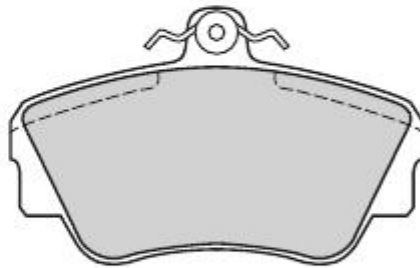



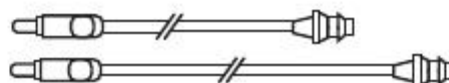
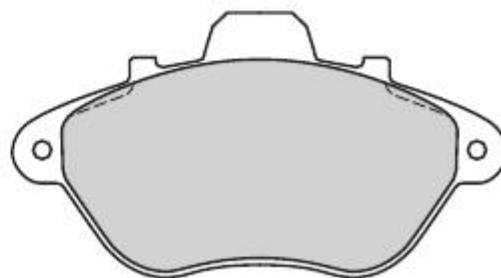

0464	VOLVO	GIRLING	X	110	67,5	17,2	4		
-------------	-------	---------	---	-----	------	------	---	--	--



0465	PEUGEOT	BENDIX	X	130,85	70	17	4	2 2	130 338
-------------	---------	--------	---	--------	----	----	---	--------	------------

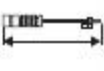

									
0466	JAGUAR - MERCEDES	GIRLING	X	114,95	80,25	17,5	2A-2B	2	240

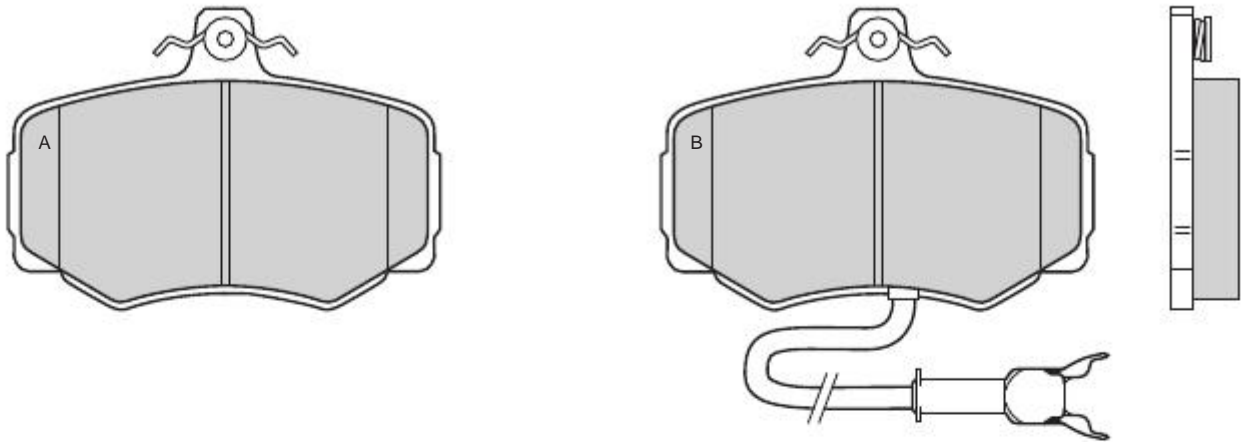



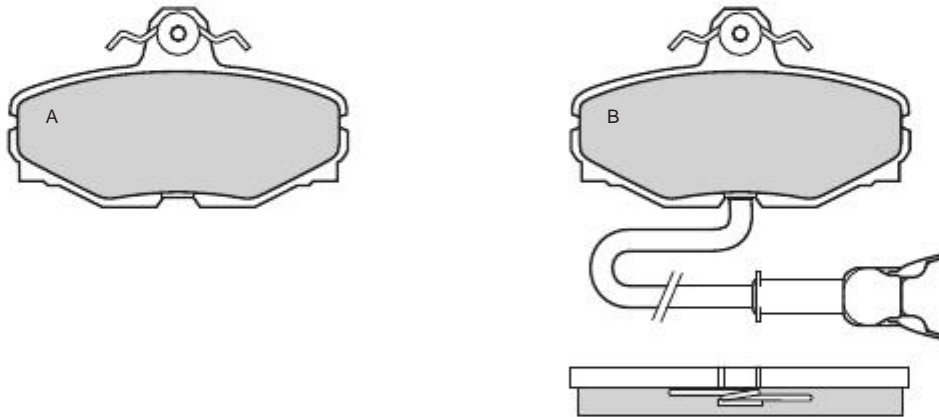



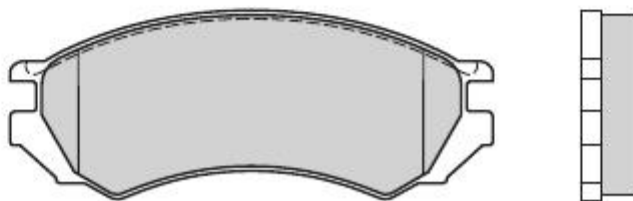

0467	JAGUAR - MERCEDES	GIRLING	X	90	53	12,5	2A-2B	2	430
-------------	-------------------	---------	---	----	----	------	-------	---	-----



0468	NISSAN	AKEBONO	X	127,9	50,45	16	4		
-------------	--------	---------	---	-------	-------	----	---	--	--

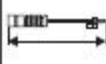

									
0470	NISSAN	GIRLING	X	128,8	57	16,5	4		

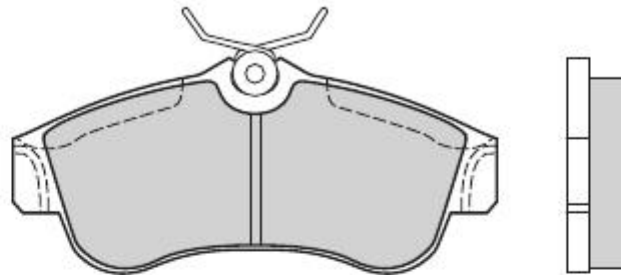



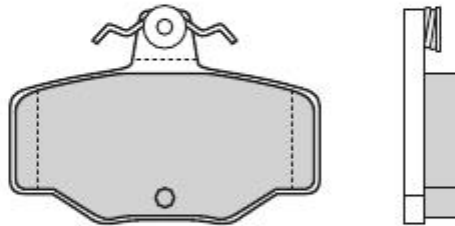



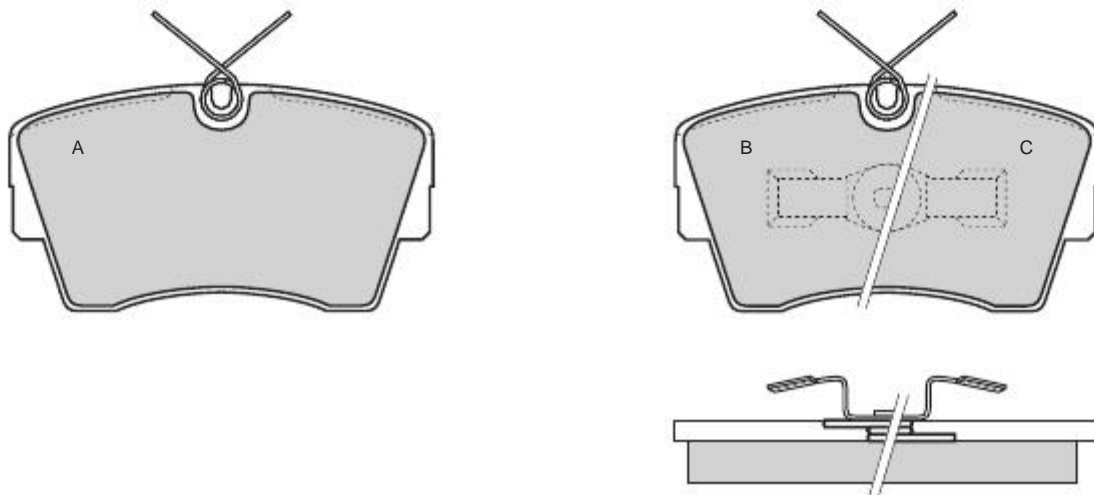

0471	NISSAN-DATSUN	GIRLING	X	82,2	57,3	15	4		
-------------	---------------	---------	---	------	------	----	---	--	--



0472	OPEL - VAUXHALL	ATE	X	112	60	17,5	2A 1B-1C		
-------------	-----------------	-----	---	-----	----	------	-------------	--	--

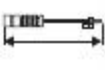

									
0473	NISSAN	SUMITOMO	X	121,05	50,45	16	2A 1B-1C		

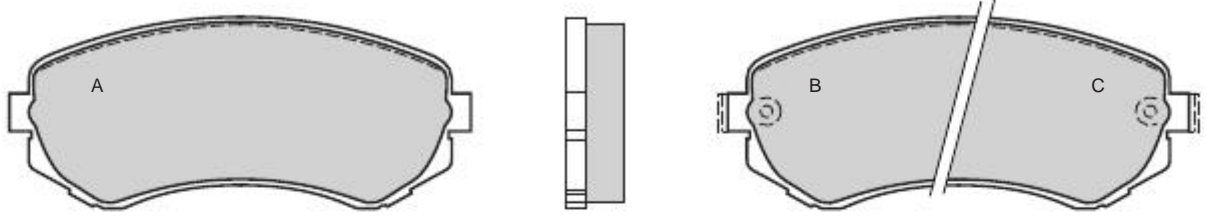



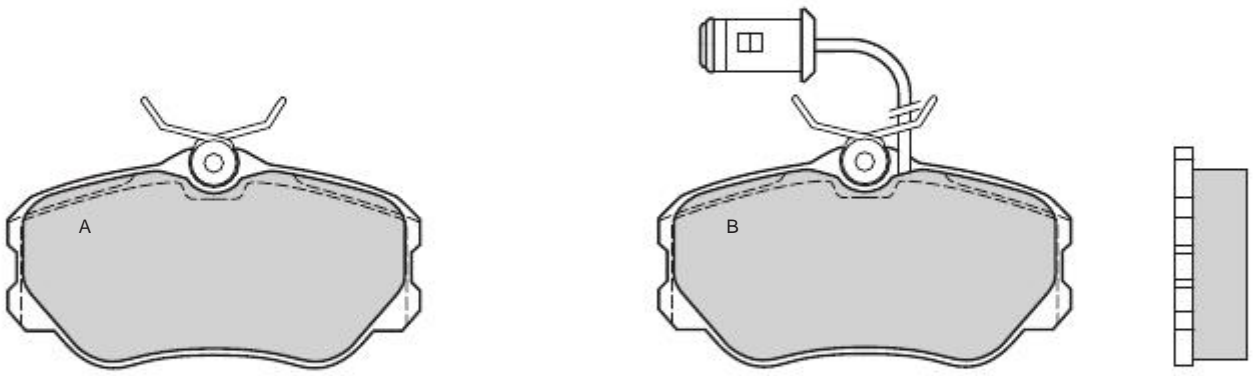



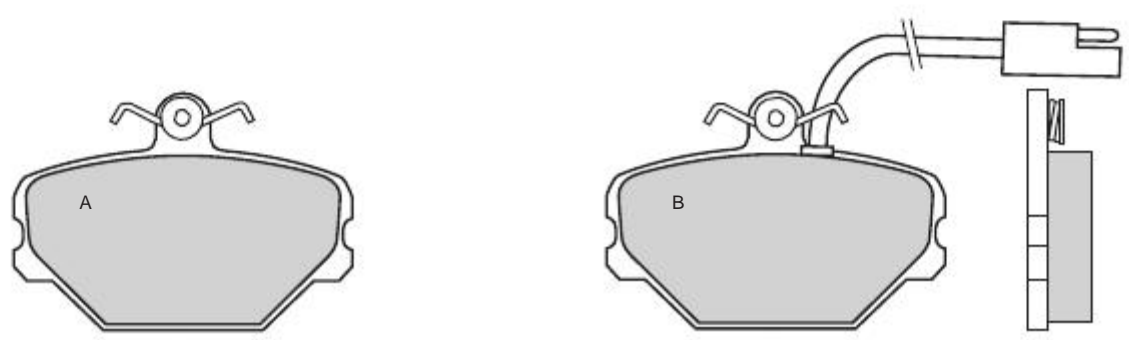

0474	ALFA ROMEO FIAT - LANCIA	GIRLING	X	109,9	58,7	19	2A-2B	2	460
-------------	-----------------------------	---------	---	-------	------	----	-------	---	-----



0475	YUGO	GIRLING	X	89,9	63,4	16,5	2A-2B	2	273
-------------	------	---------	---	------	------	------	-------	---	-----

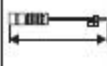

									
0476	TOYOTA	AKEBONO	X	116,1	53,4	15,4	4		

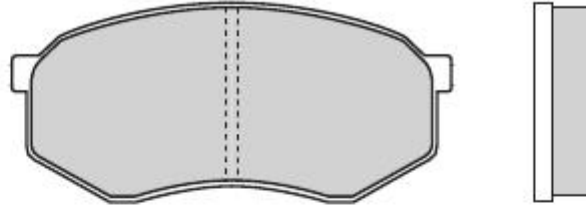





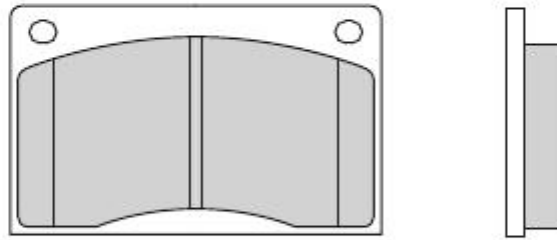



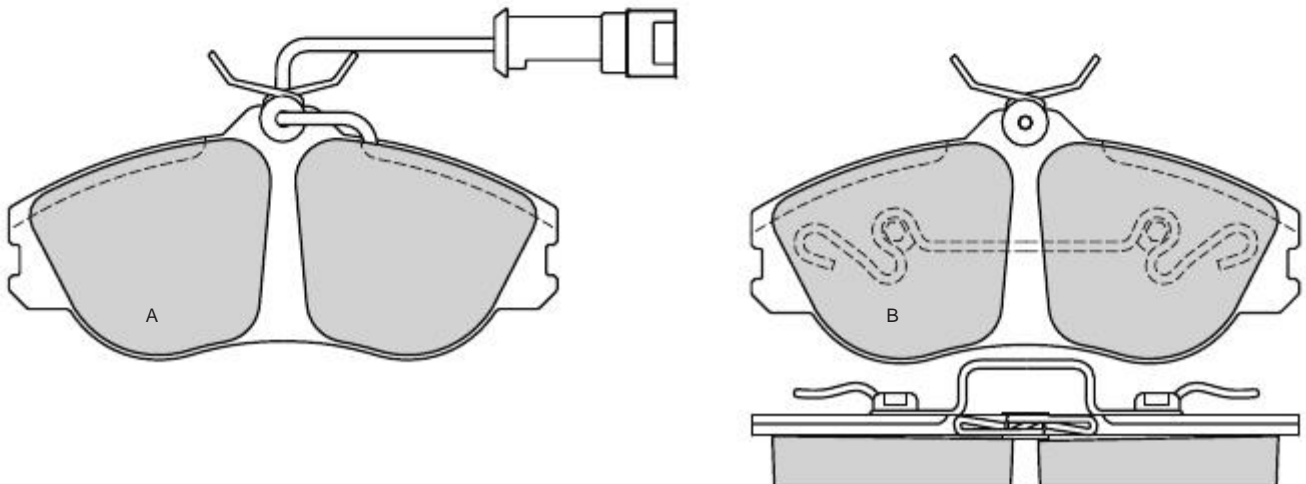

OPTIONAL

0477	VOLVO	GIRLING	X	98,4	60,4	16	4		
-------------	-------	---------	---	------	------	----	---	--	--



0478	AUDI	GIRLING	X	144,9	67,1	19	2A-2B	2	315
-------------	------	---------	---	-------	------	----	-------	---	-----

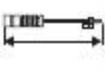

									
0479	HONDA	AKEBONO	X	132,2	49,5	15	2A 1B-1C		

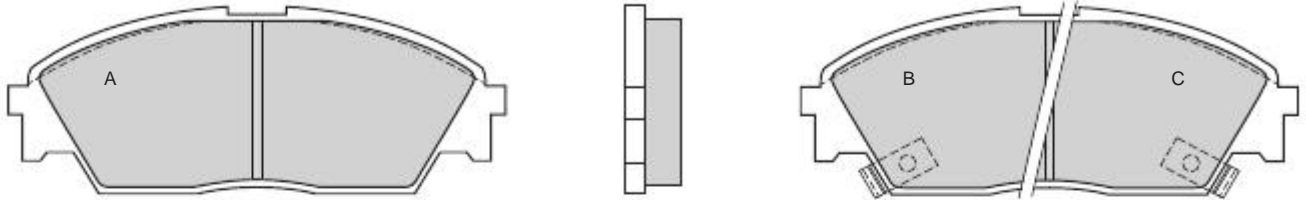



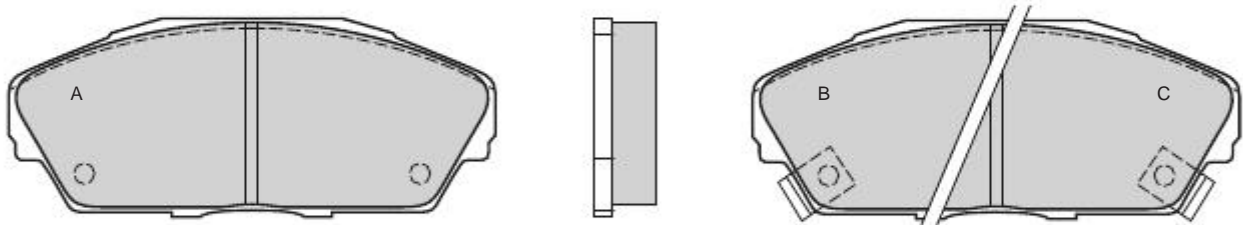



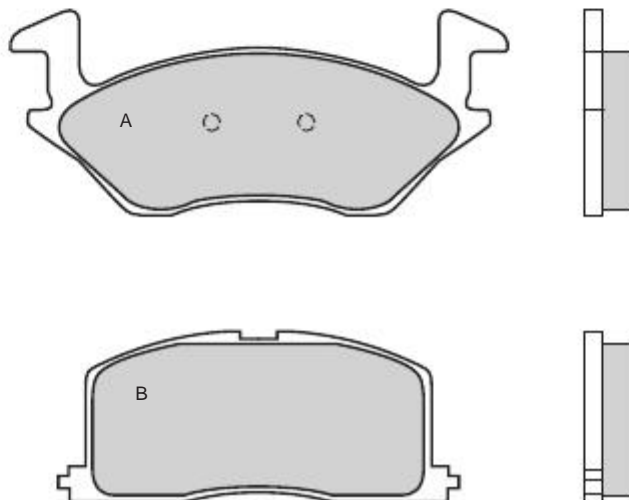

0480	HONDA	AKEBONO	X	129,1	53	16,8	2A 1B-1C		
-------------	-------	---------	---	-------	----	------	-------------	--	--



0481	TOYOTA	AKEBONO	X	A 131,9 B 106,2	A 54,3 B 45,7	13,5	2A-2B		
-------------	--------	---------	---	--------------------	------------------	------	-------	--	--

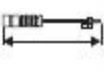

									
0482	HONDA	AKEBONO	X	137,8	52,6	18	2A 1B-1C		

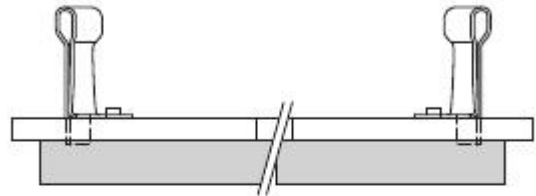
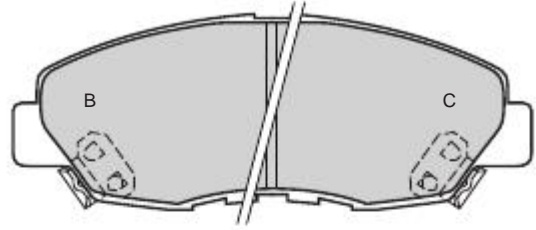
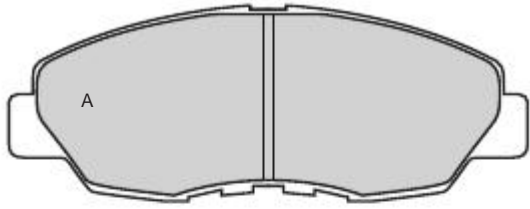



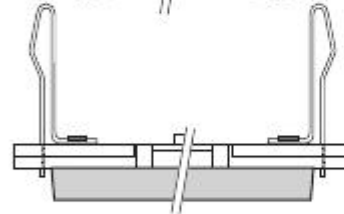
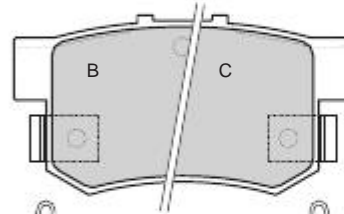
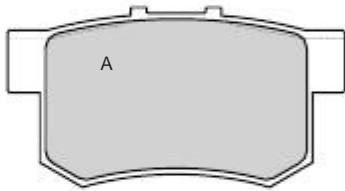



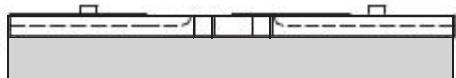
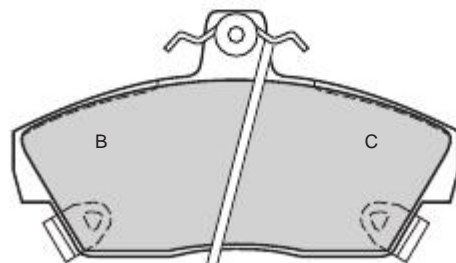
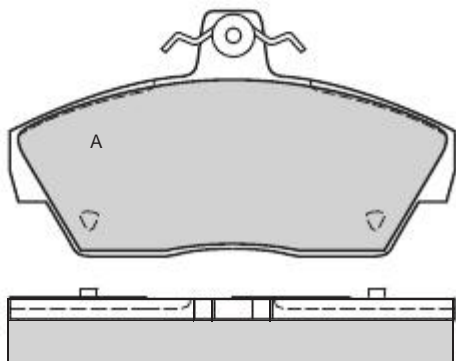



0483	HONDA - ROVER	AKEBONO	X	88,9	47,8	14,5	2A 1B-1C		
-------------	---------------	---------	---	------	------	------	-------------	--	--



0484	HONDA - ROVER	GIRLING	X	117,5	65,50	18,20	2A 1B-1C		
-------------	---------------	---------	---	-------	-------	-------	-------------	--	--



									
0485	MERCEDES	GIRLING	X	109,9	60	19,2	2A-2B	2	200

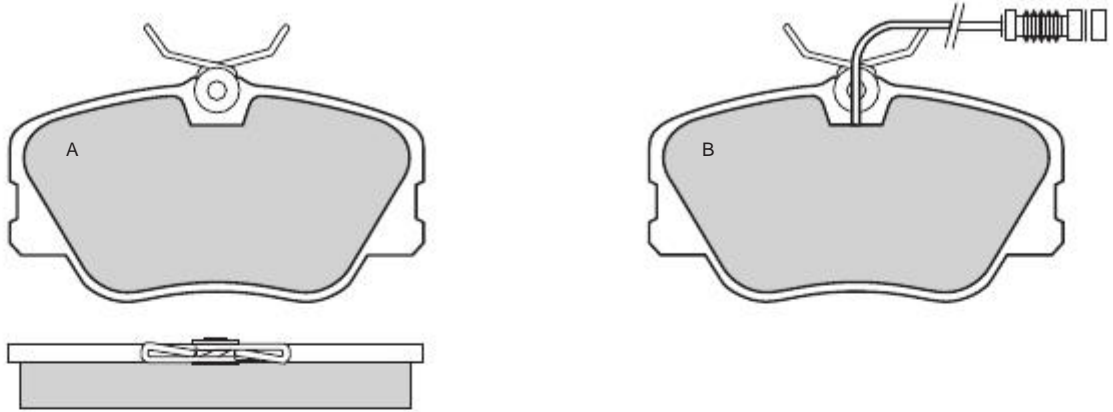



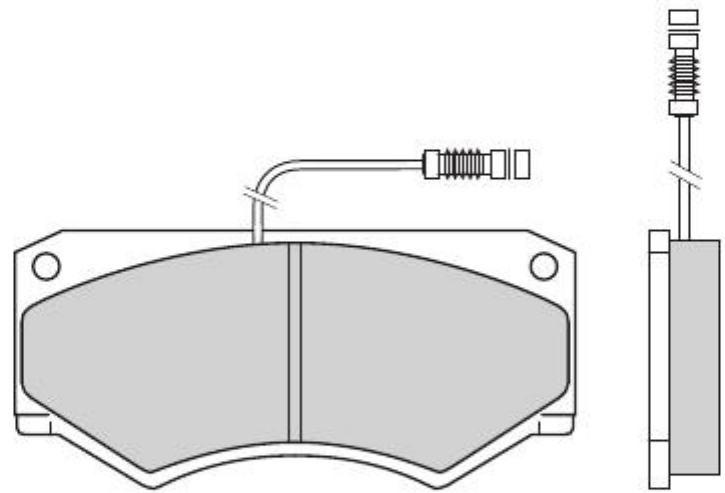



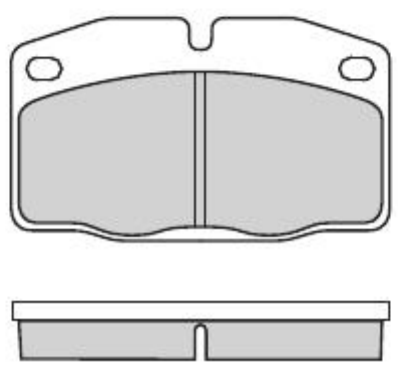

0486	MERCEDES	PERROT	X	149,1	69,1	18	4	4	113
-------------	----------	--------	---	-------	------	----	---	---	-----



0487	OPEL - VAUXHALL	DELCO	X	100,1	59,1	15,5	4		
-------------	-----------------	-------	---	-------	------	------	---	--	--

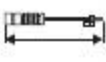

									
0488	DAIHATSU - MAZDA	AKEBONO	X	102,3	39,3	13,5	4		

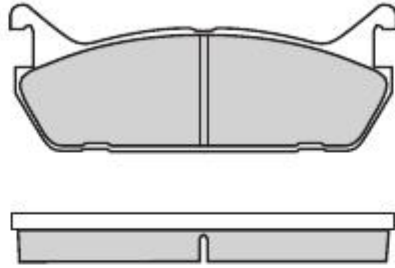



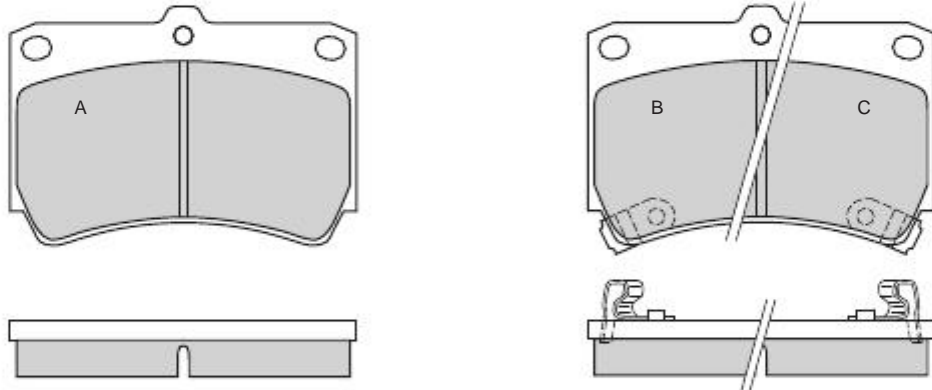



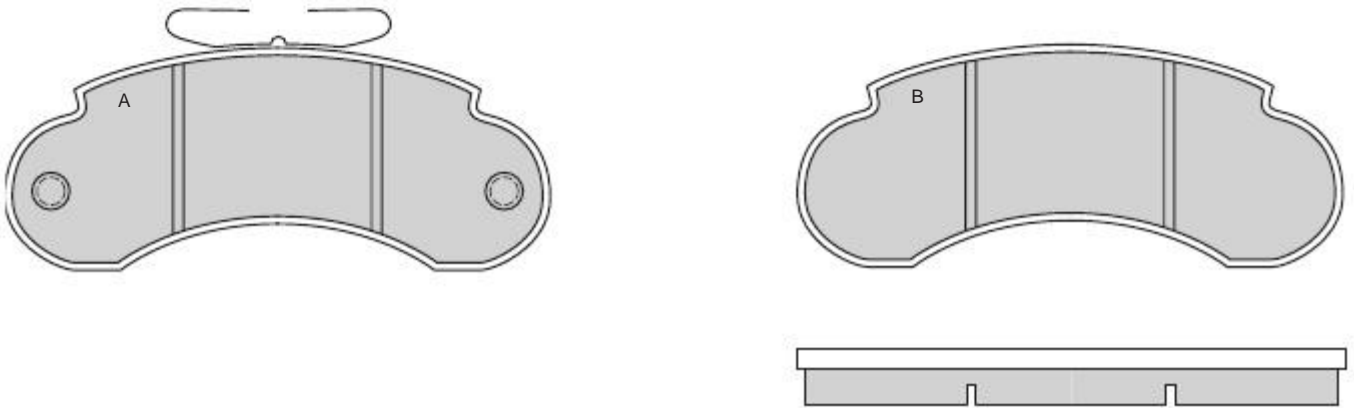

0489	MAZDA	SUMITOMO	X	91,7	64	15	2A 1B-1C		
------	-------	----------	---	------	----	----	-------------	--	--



0490	MERCEDES	BENDIX	X	145,6	59,2	14	2A-2B		
------	----------	--------	---	-------	------	----	-------	--	--

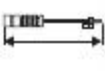

									
0491	FORD USA - MAZDA	SUMITOMO	X	91,8	71,2	15	2A 1B-1C		

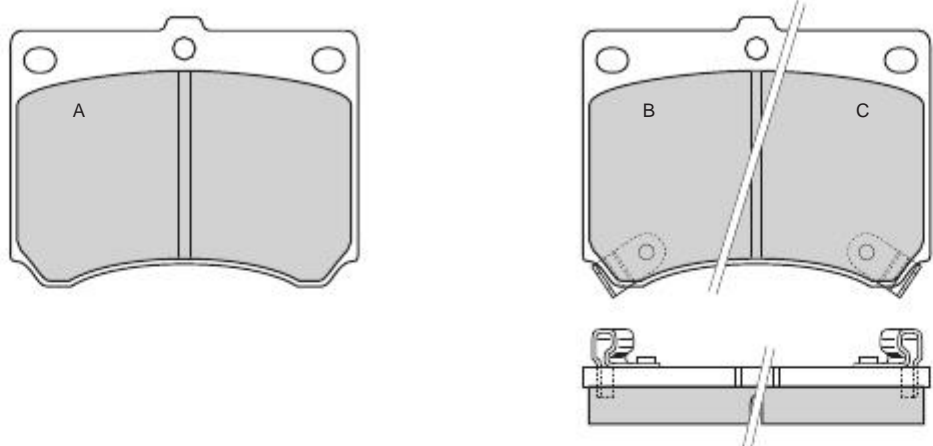



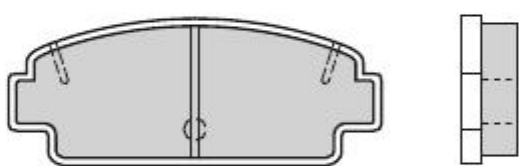



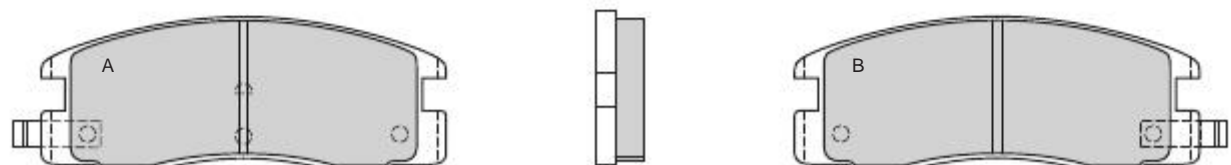



0492	TOYOTA	AKEBONO	X	98,75	38,8	14,5	4		
-------------	--------	---------	---	-------	------	------	---	--	--



0493	TOYOTA	AKEBONO	X	107,3	40,4	13	2A-2B		
-------------	--------	---------	---	-------	------	----	-------	--	--



									
0494	HYUNDAI - NISSAN	AKEBONO	X	137,1	54,05	17	2A 1B-1C		

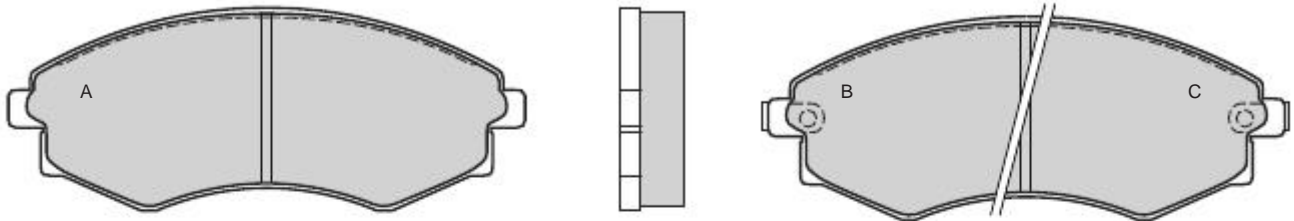



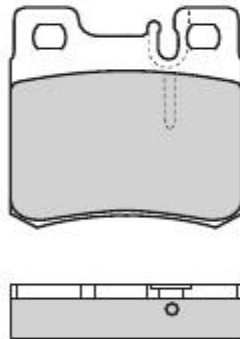



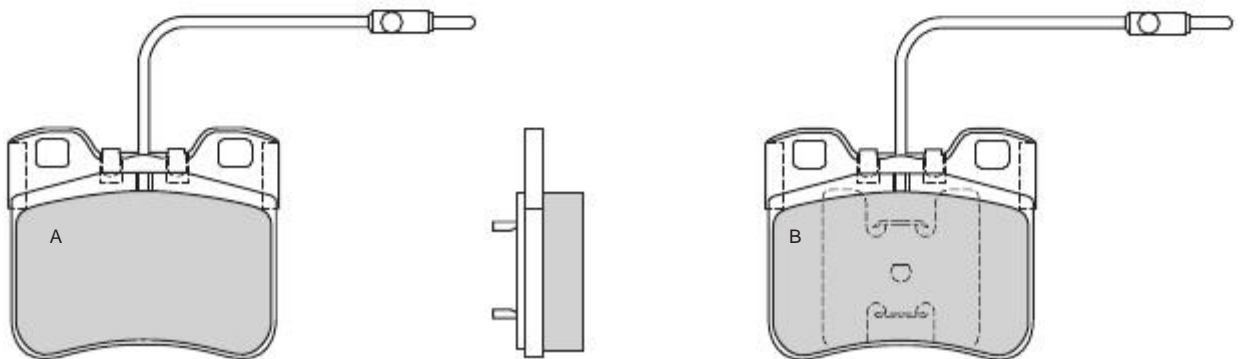



0495	MERCEDES	ATE	X	61,7	58,4	15,2	4		
-------------	----------	-----	---	------	------	------	---	--	--



0496	CITROEN - PEUGEOT	CITROEN	X	71,95	60,6	16,5	2A-2B	4	175
-------------	-------------------	---------	---	-------	------	------	-------	---	-----



									
0497	AUDI - VOLKSWAGEN	GIRLING	X	119,6	69,7	16,6	2A-2B	2	260

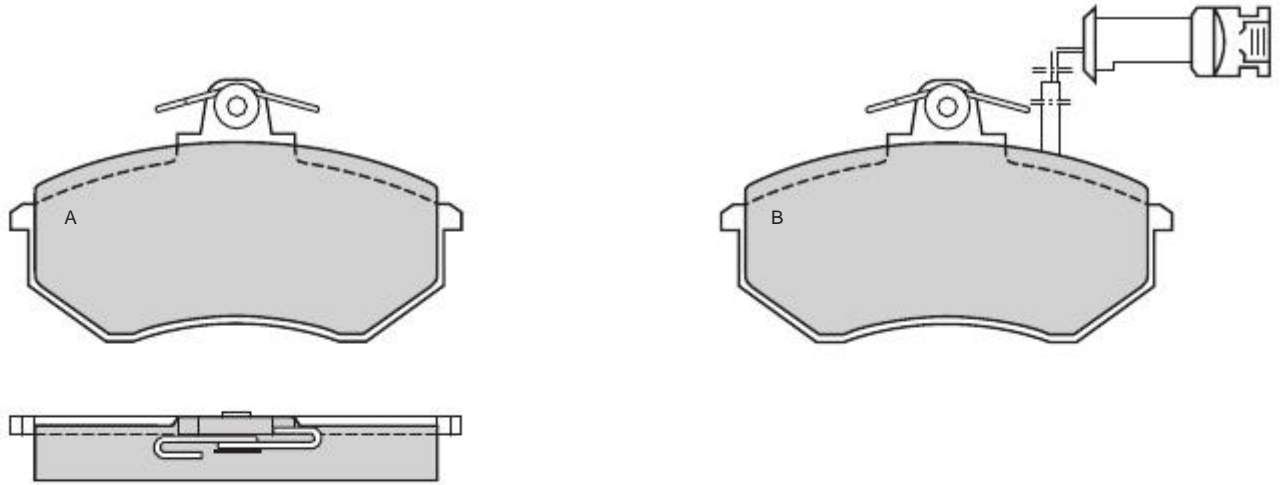



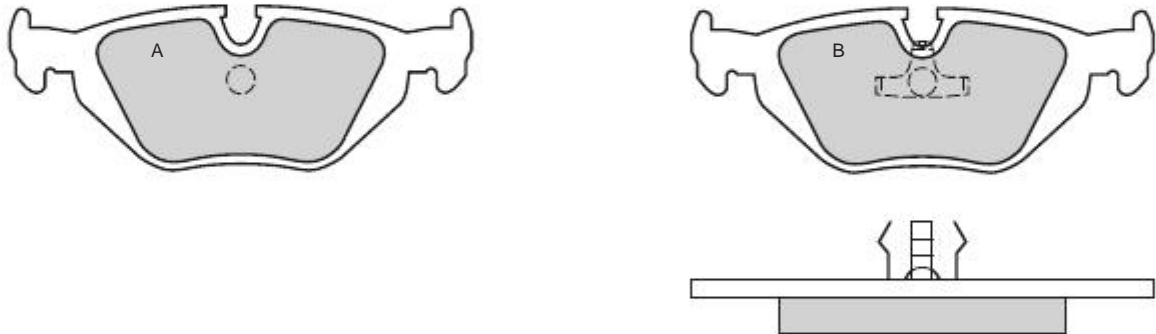



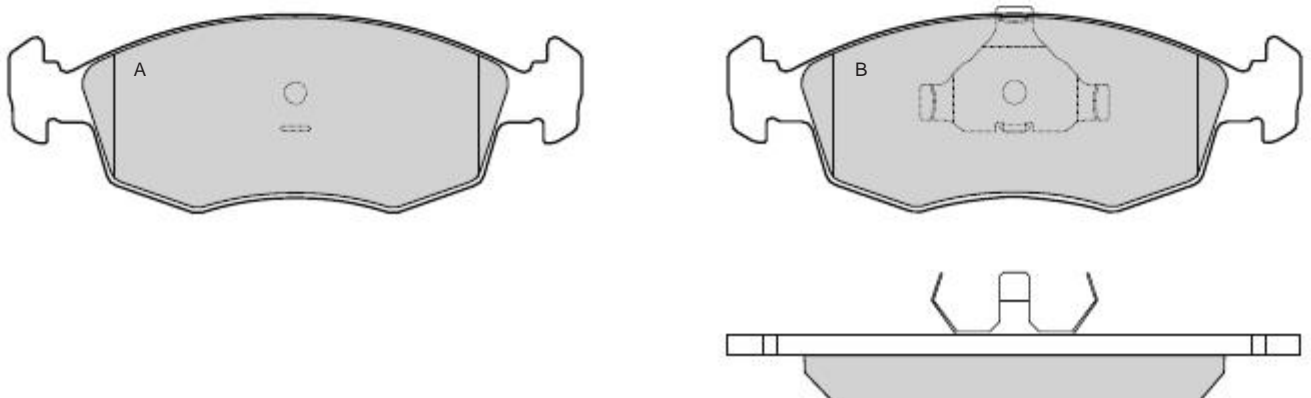

0498	BMW	ATE	X	123	43,5	16,5	2A-2B		
-------------	-----	-----	---	-----	------	------	-------	--	--



0499	FORD	ATE	X	151,3	52,5	17,5	2A-2B		
-------------	------	-----	---	-------	------	------	-------	--	--

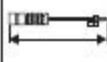

									
0500	FORD	GIRLING	X	89,8	54	13,7	4		

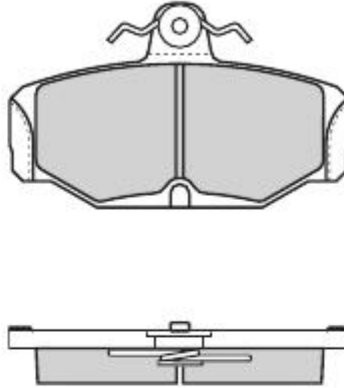



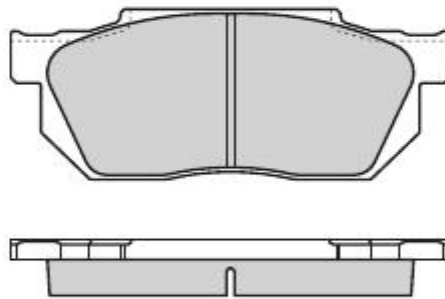



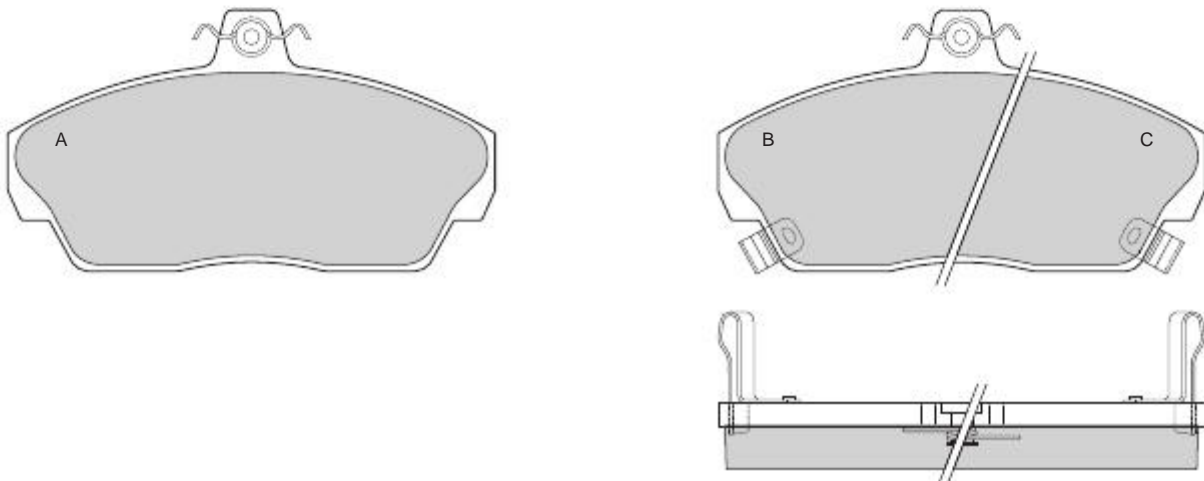

0501	HONDA	AKEBONO	X	116	45,5	15	4		
------	-------	---------	---	-----	------	----	---	--	--



0502	HONDA - ROVER	GIRLING	X	129,1	68,6	17,5	2A 1B-1C		
------	---------------	---------	---	-------	------	------	-------------	--	--

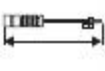

									
0503	HONDA	AKEBONO	X	127,7	48,6	15	4		

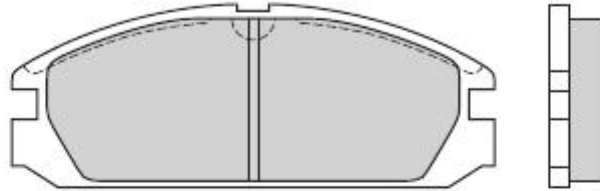



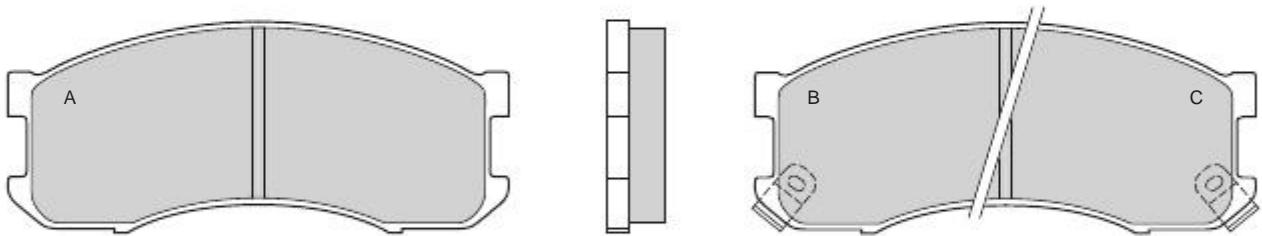



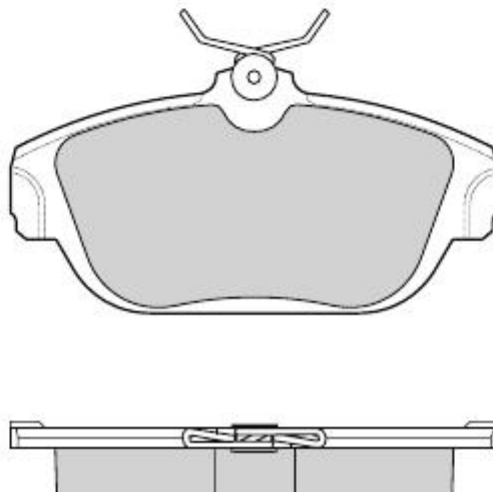



0504	MAZDA	AKEBONO	X	133	56	15,5	2A 1B-1C		
-------------	-------	---------	---	-----	----	------	-------------	--	--



0505	VOLVO	GIRLING	X	128,9	64,8	18	4		
-------------	-------	---------	---	-------	------	----	---	--	--



									
0506	MERCEDES	ATE	X	99,5	73,4	17,5	4	2	130

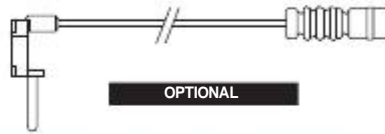
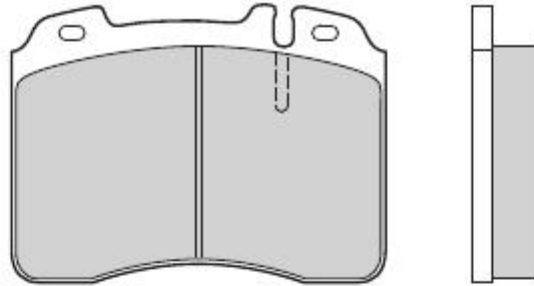



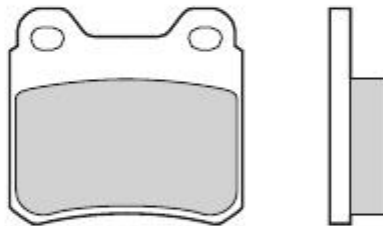



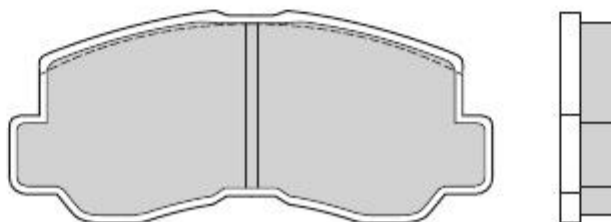

0507	MERCEDES	ATE	X	61,7	57,4	15,5	4		
-------------	----------	-----	---	------	------	------	---	--	--



0508	MITSUBISHI	AKEBONO	X	127,6	56,3	15,5	4		
-------------	------------	---------	---	-------	------	------	---	--	--

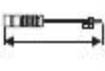

									
0509	MITSUBISHI - PLYMOUTH PROTON	AKEBONO	X	127,9	51,9	16	2A 1B-1C		

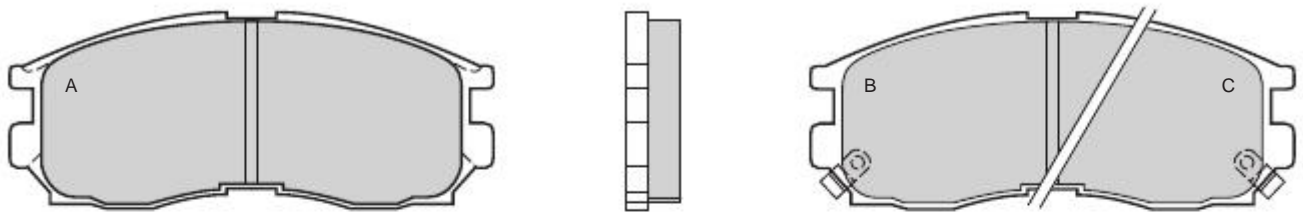



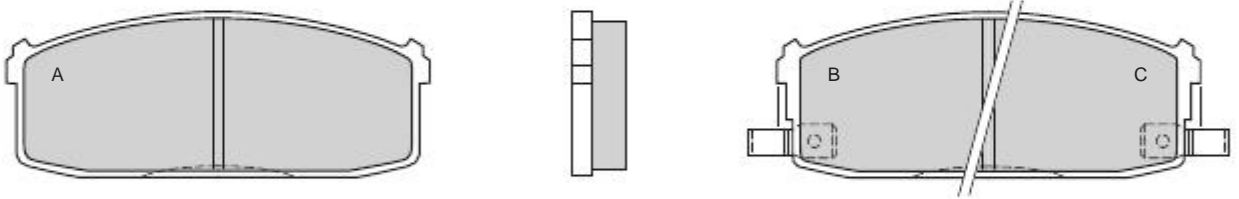



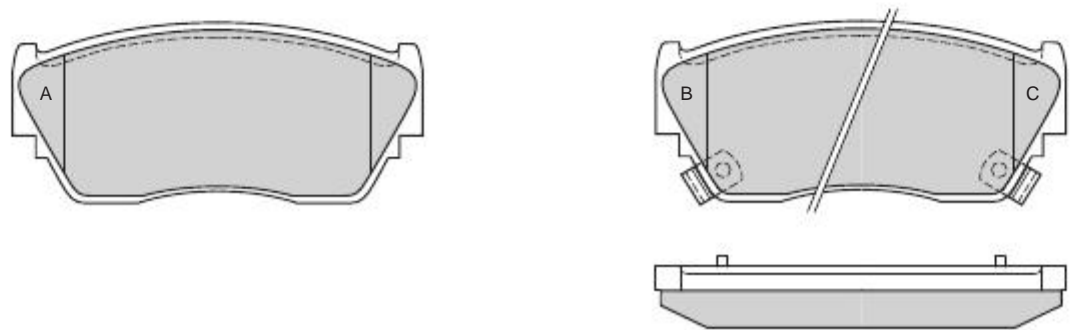

0510	NISSAN	SUMITOMO	X	111,9	44	14,5	2A 1B-1C		
-------------	--------	----------	---	-------	----	------	-------------	--	--



0511	NISSAN	SUMITOMO	X	108,4	47,85	16,5	2A 1B-1C		
-------------	--------	----------	---	-------	-------	------	-------------	--	--

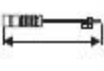

									
0512	NISSAN	SUMITOMO	X	127,8	51,7	15	2A 1B-1C		

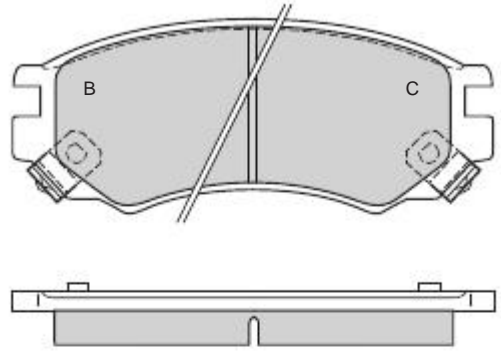
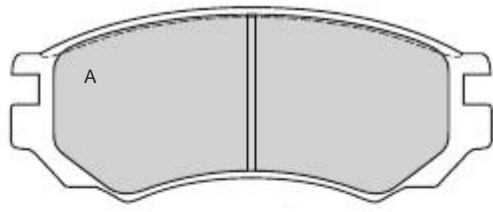



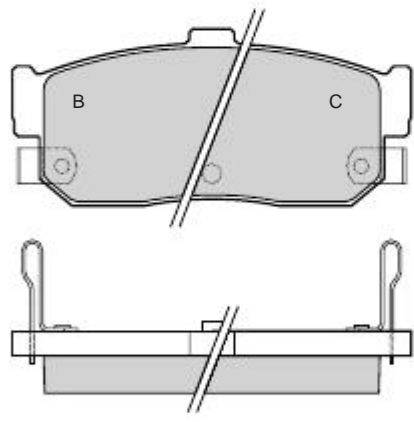
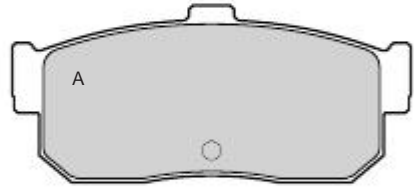



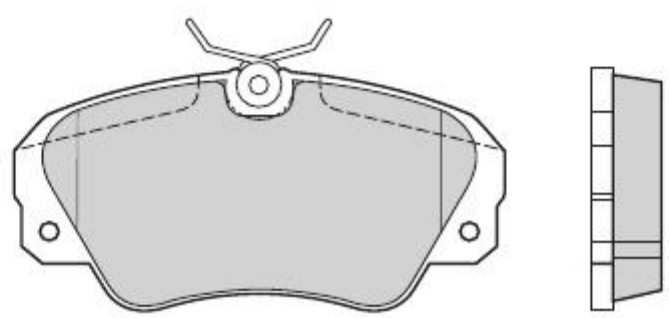

0513	NISSAN	SUMITOMO	X	105,3	46,8	16,4	2A 1B-1C		
-------------	--------	----------	---	-------	------	------	-------------	--	--



0514	OPEL - VAUXHALL	GIRLING	X	129,9	64	18,5	4		
-------------	-----------------	---------	---	-------	----	------	---	--	--

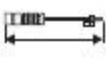

									
0515	MAZDA	SUMITOMO	X	110,1	45,1	14,2	4		

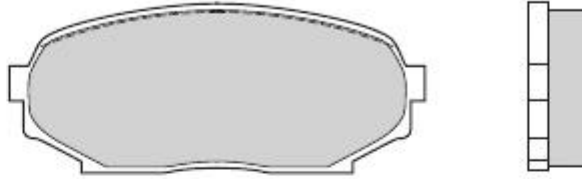



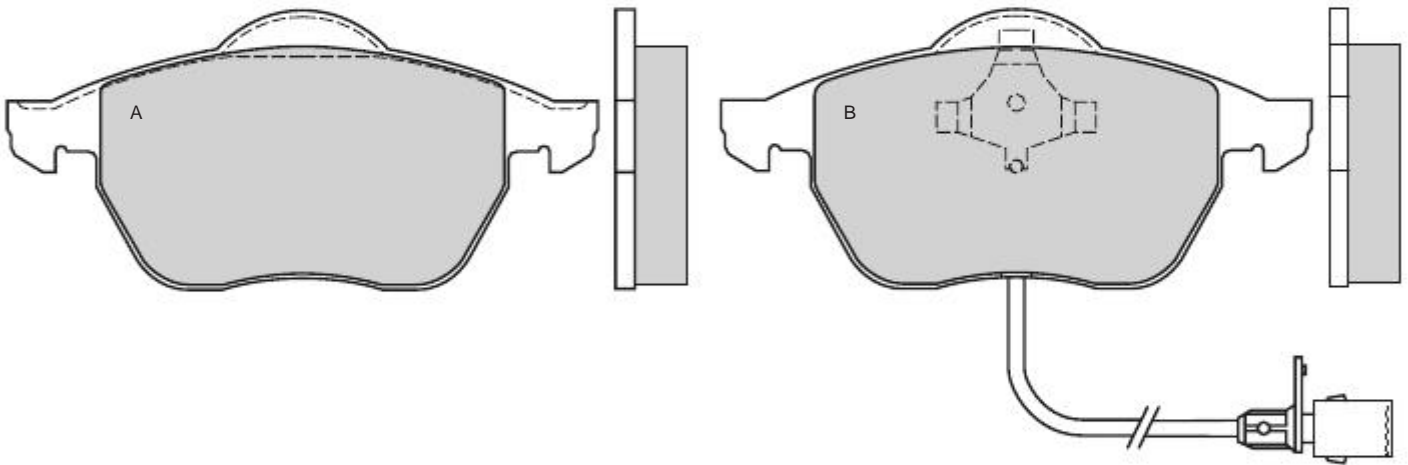



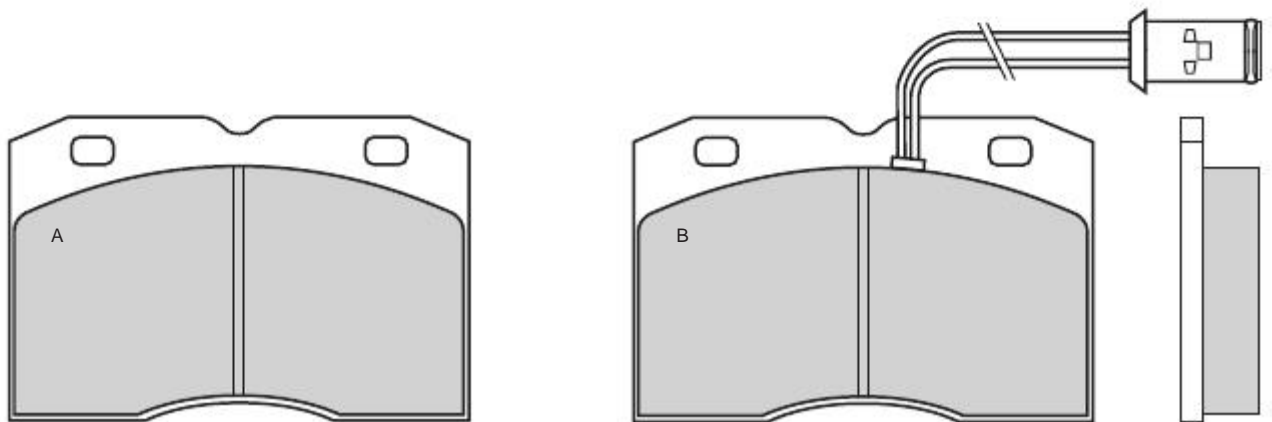

0516	AUDI	ATE	X	156,5	74,2	A 19,5 B 20,5	2A-2B	2	210
------	------	-----	---	-------	------	------------------	-------	---	-----



0517	FIAT - IVECO	BREMBO	X	109,8	73	18	2A-2B	2	225
------	--------------	--------	---	-------	----	----	-------	---	-----

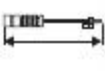

									
0518	LAND ROVER	LOCKHEED	X	104,9	72,3	18,5	3A-1B		225

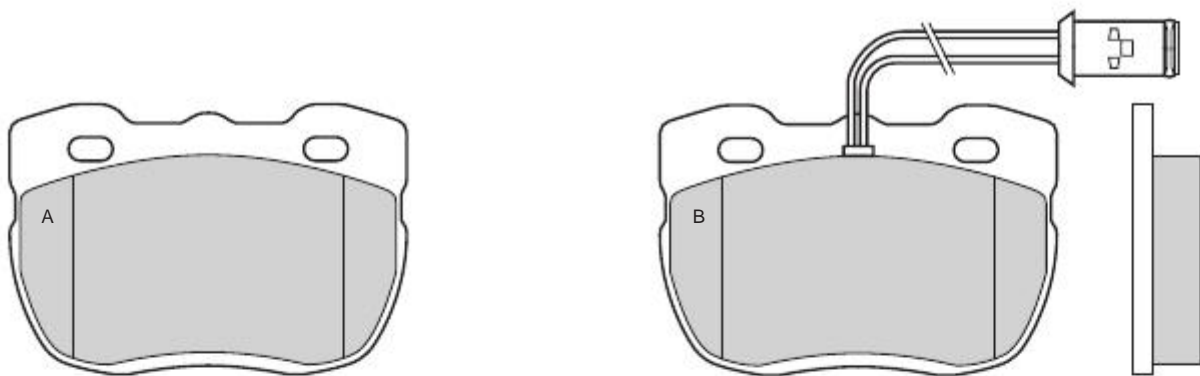



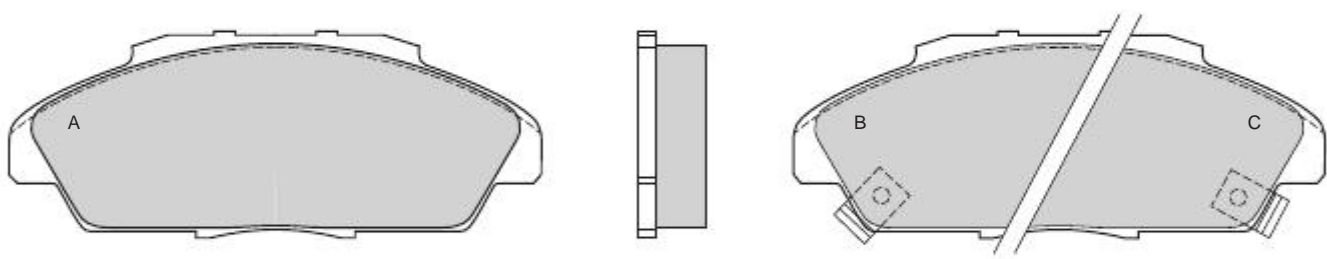



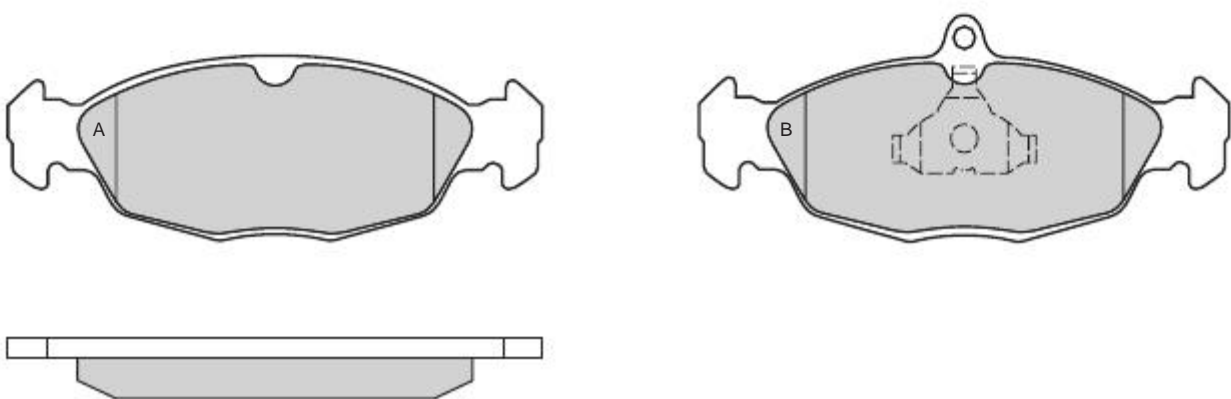

0519	HONDA	AKEBONO	X	141,1	54,4	18,5	2A 1B-1C		
-------------	-------	---------	---	-------	------	------	-------------	--	--



0520	DAEWOO - OPEL VAUXHALL	ATE	X	A 140,1 B 141,3	A 58,3 B 48,3	16,5	2A-2B		
-------------	---------------------------	-----	---	--------------------	------------------	------	-------	--	--

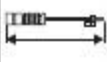

										
0521	CITROEN - PEUGEOT	BENDIX	X	131,1	73,1	17	2A-2B	2	2	130 338

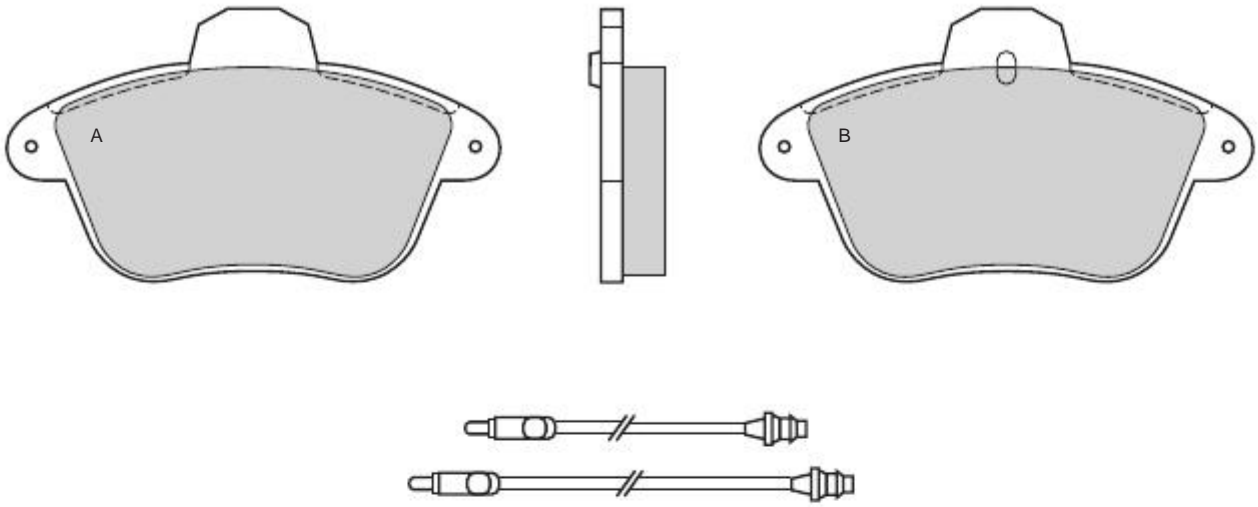



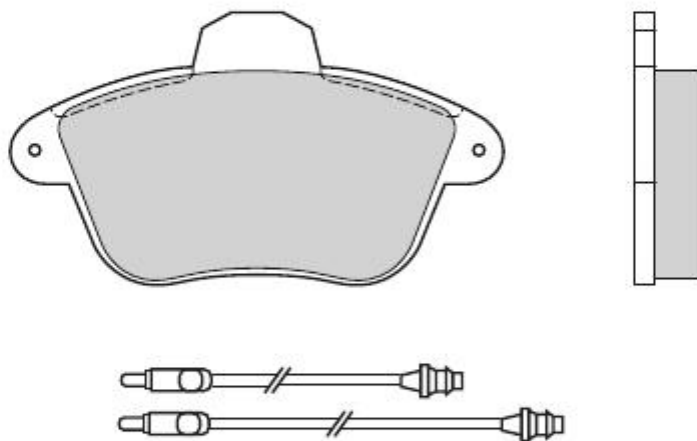



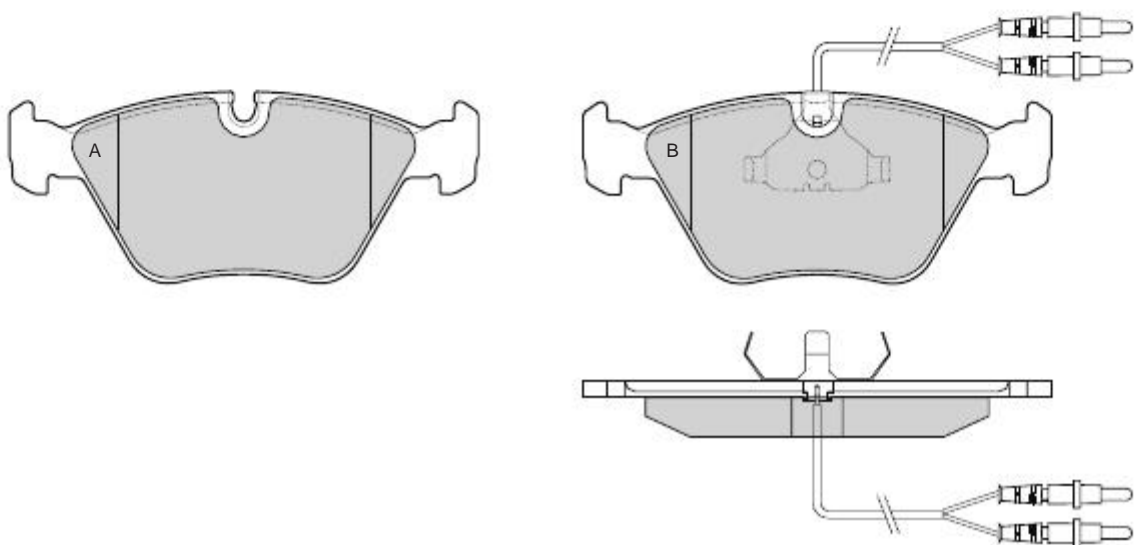

0522	PEUGEOT	BENDIX	X	131,1	73,1	17	4	2	2	130 338
-------------	---------	--------	---	-------	------	----	---	---	---	------------



0523	PEUGEOT	ATE	X	156,4	64	18,7	2A-2B	2	2	262
-------------	---------	-----	---	-------	----	------	-------	---	---	-----

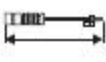

									
0524	PEUGEOT	BENDIX	X	144,1	58	18	4	2	200

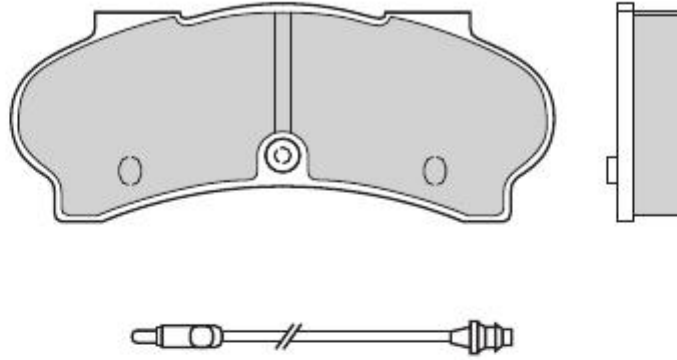



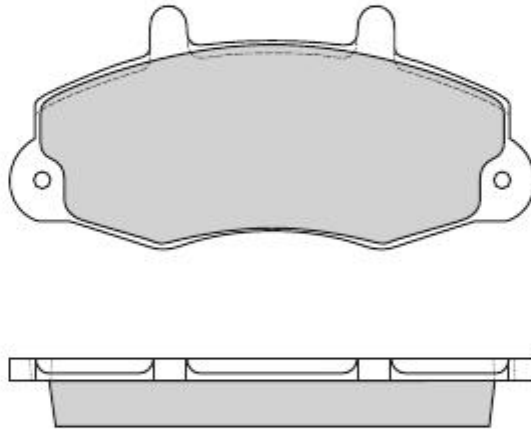



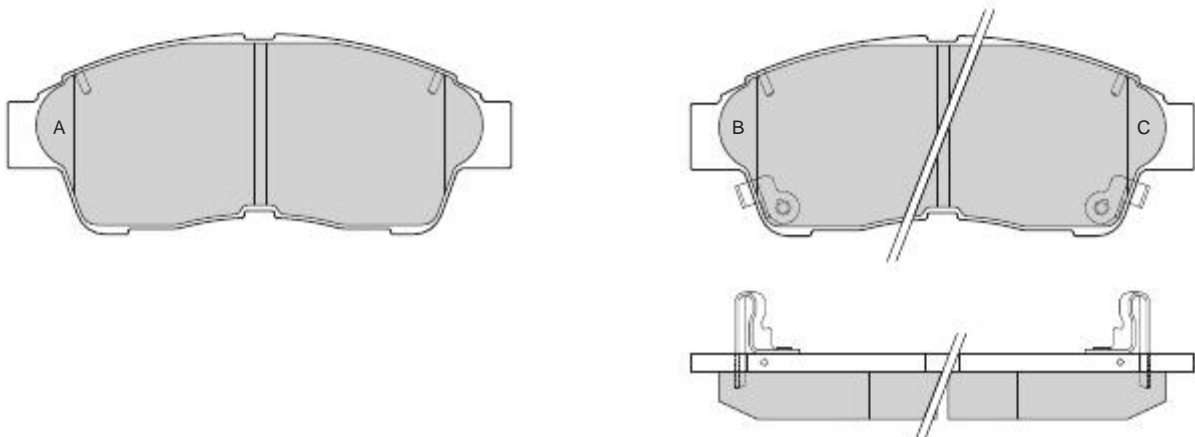

0525	FORD	BENDIX	X	138,9	64,1	18,7	4		
-------------	------	--------	---	-------	------	------	---	--	--



0526	TOYOTA	AKEBONO	X	133,1	53,1	17,5	2A 1B-1C		
-------------	--------	---------	---	-------	------	------	-------------	--	--

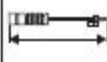

									
0527	RENAULT	GIRLING	X	130,1	55,8	18,5	2A-2B	2	305

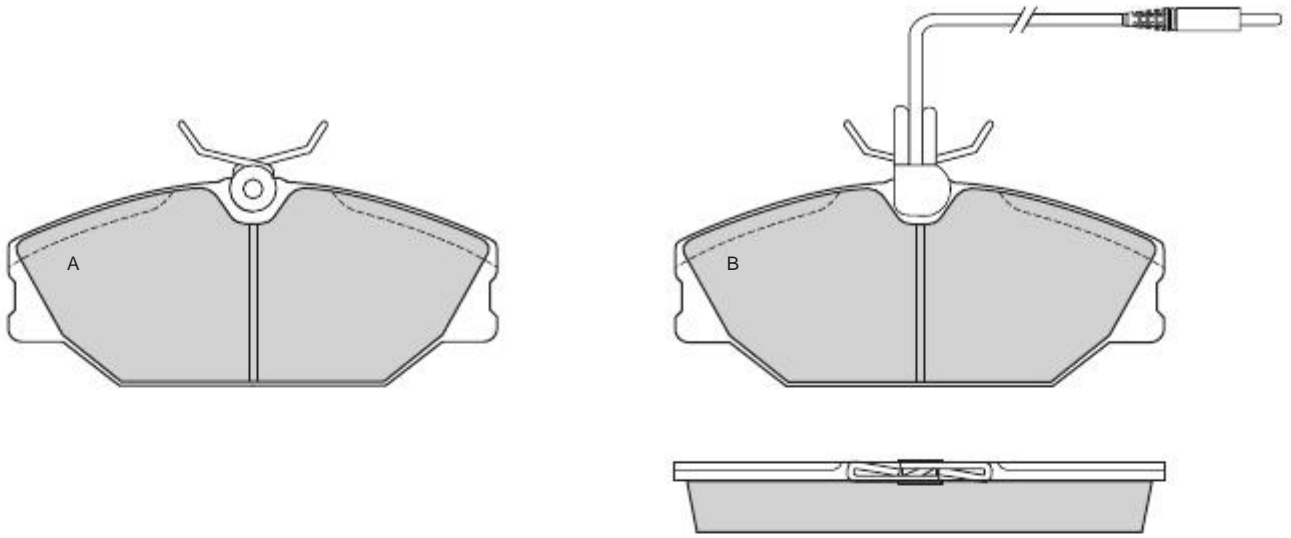



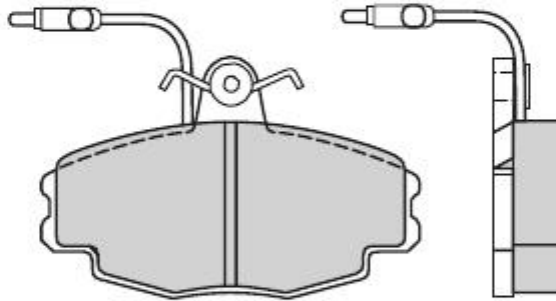



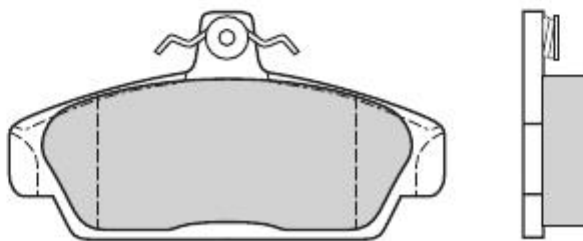



0528	CITROEN	GIRLING	X	100	64	18	4	4	370
-------------	---------	---------	---	-----	----	----	---	---	-----



0529	ROVER	GIRLING	X	115	60,2	17,8	4		
-------------	-------	---------	---	-----	------	------	---	--	--



									
0530	ROVER	AKEBONO	X	89	35,5	13	2A 1B-1C		

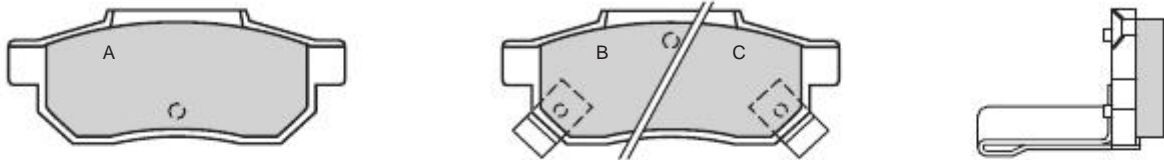



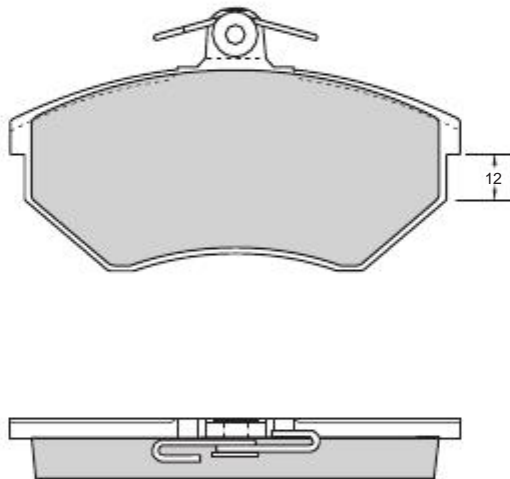



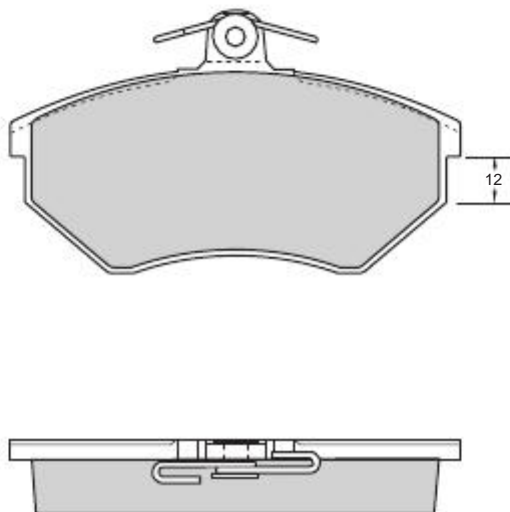

0531	SEAT - VOLKSWAGEN	GIRLING	X	118,9	69,5	16	4		
-------------	-------------------	---------	---	-------	------	----	---	--	--



0532	AUDI - SEAT - VOLKSWAGEN	GIRLING	X	118,9	69,5	19,6	4		
-------------	--------------------------	---------	---	-------	------	------	---	--	--

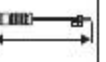

									
0533	AUDI - VOLKSWAGEN	GIRLING	X	118,9	69,5	19,6	2A-2B	2	260

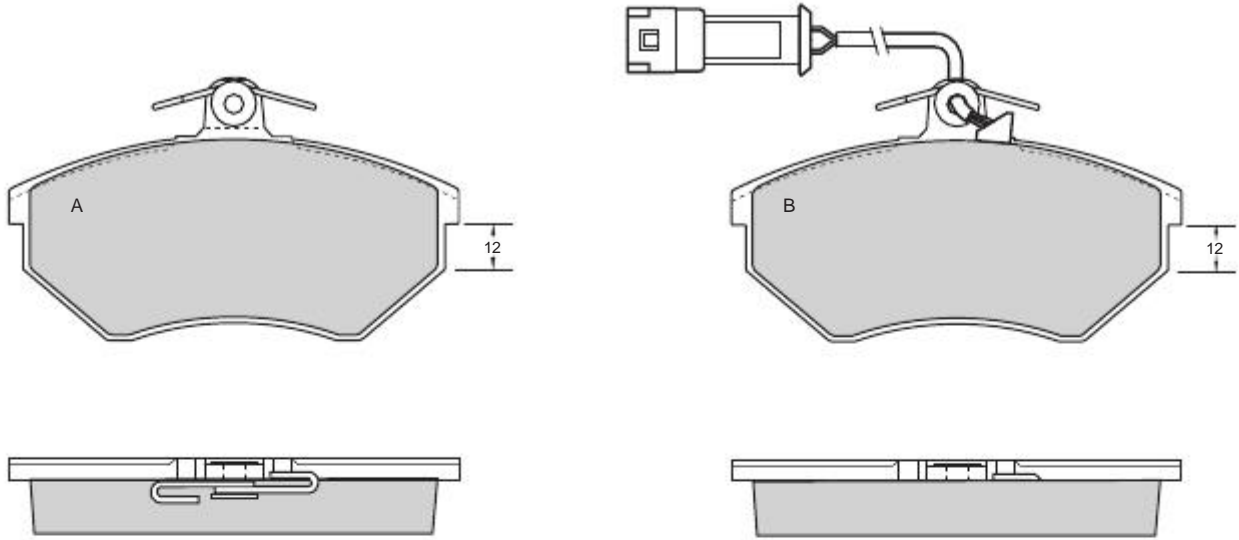



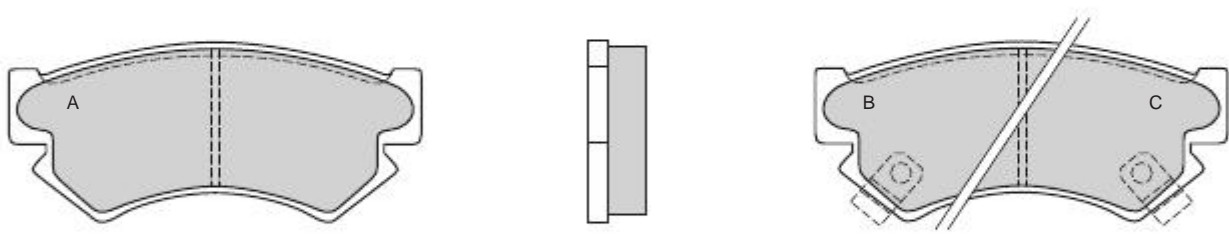



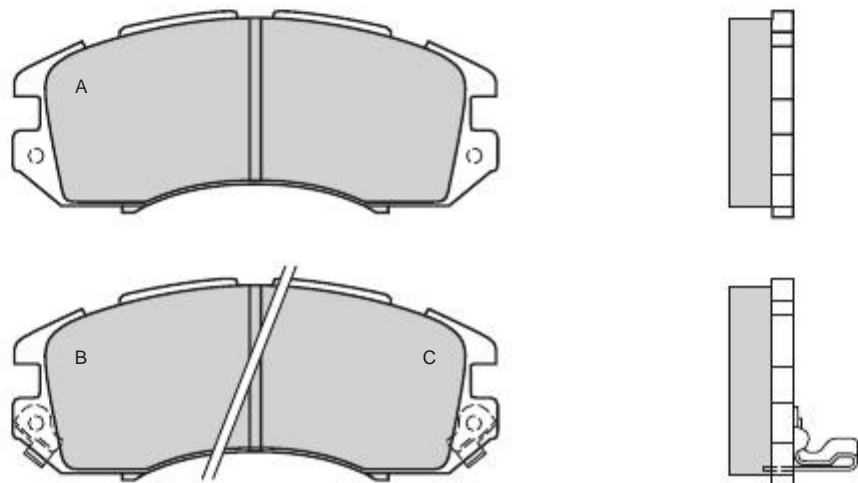



0534	SUBARU	SUMITOMO	X	108,8	48	14,8	2A 1B-1C		
------	--------	----------	---	-------	----	------	-------------	--	--



0535	SUBARU	AKEBONO	X	128,1	54,4	17	2A 1B-1C		
------	--------	---------	---	-------	------	----	-------------	--	--



									
0536	SUBARU	SUMITOMO	X	108	38,8	15	2A 1B-1C		

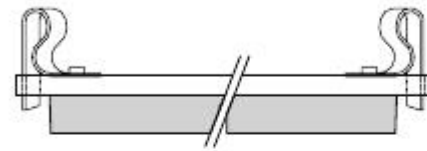
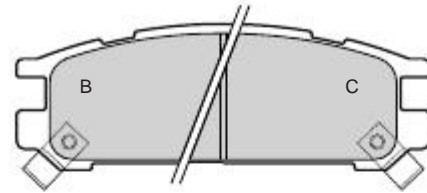
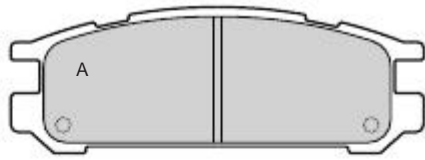



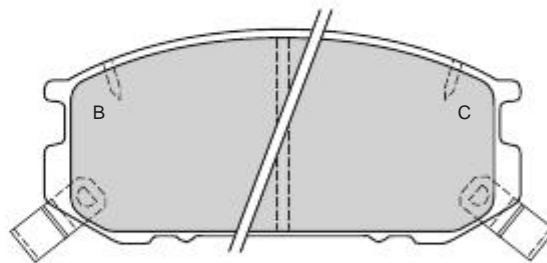
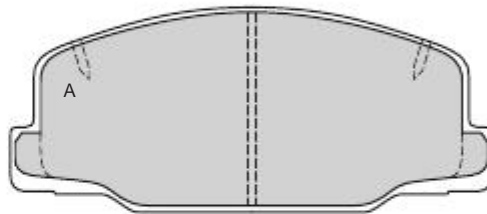



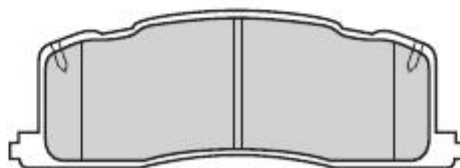

0537	TOYOTA	AKEBONO	X	A 128,3 B 126,8	A 55,1 B 58,6	15,6	2A 1B-1C		
------	--------	---------	---	--------------------	------------------	------	-------------	--	--



0538	TOYOTA	AKEBONO	X	119,6	43	15,3	4		
------	--------	---------	---	-------	----	------	---	--	--

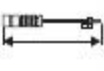

									
0539	TOYOTA	AKEBONO	X	A 128,4 B 137	A 52 B 55	15,5	2A 1B-1C		

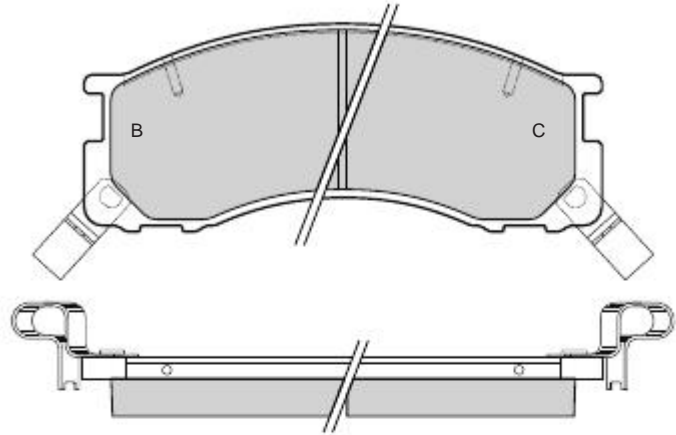
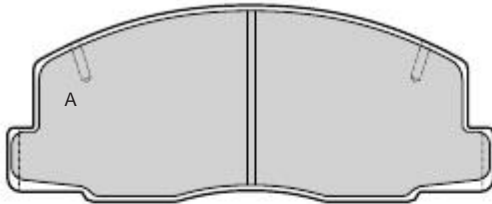



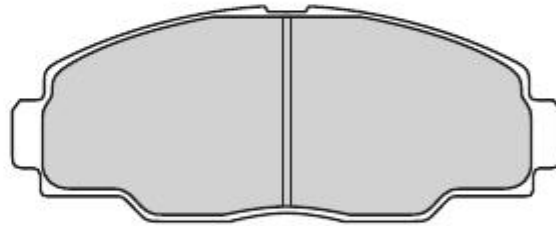



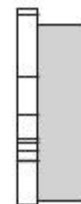
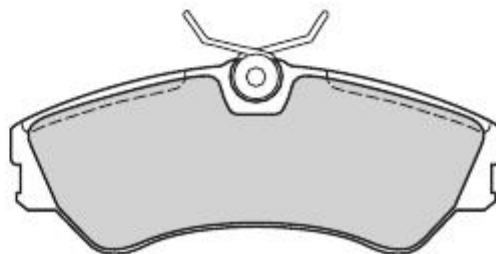



0540	TOYOTA	SUMITOMO	X	144,4	56,8	15,5	4		
-------------	--------	----------	---	-------	------	------	---	--	--



0541	VOLKSWAGEN	GIRLING	X	129,9	52	19	4		
-------------	------------	---------	---	-------	----	----	---	--	--



									
0542	VOLVO	GIRLING	X	90	53,6	13	4		

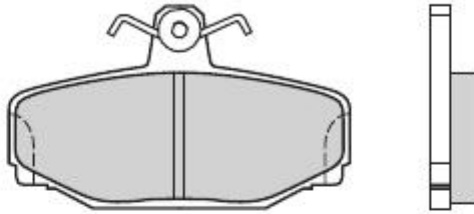



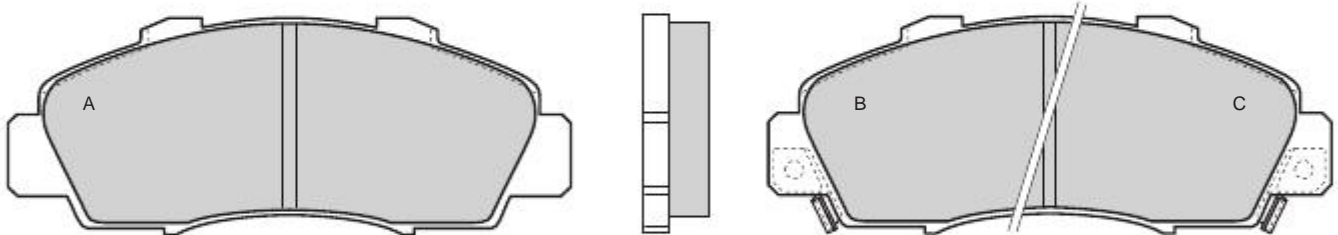



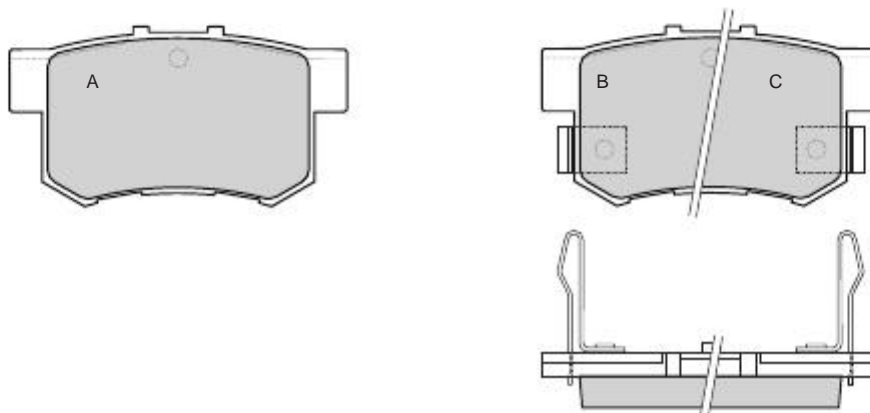



0543	HONDA - ROVER	AKEBONO	X	148,9	57,8	17,3	2A 1B-1C		
------	---------------	---------	---	-------	------	------	-------------	--	--



0544	HONDA - ROVER	AKEBONO	X	89	47,5	14,5	2A 1B-1C		
------	---------------	---------	---	----	------	------	-------------	--	--



									
0545	HONDA	AKEBONO	X	110,7	56,6	15	2A 1B-1C		

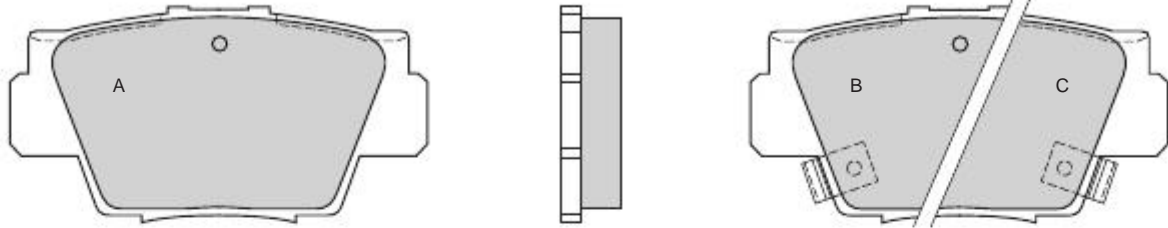



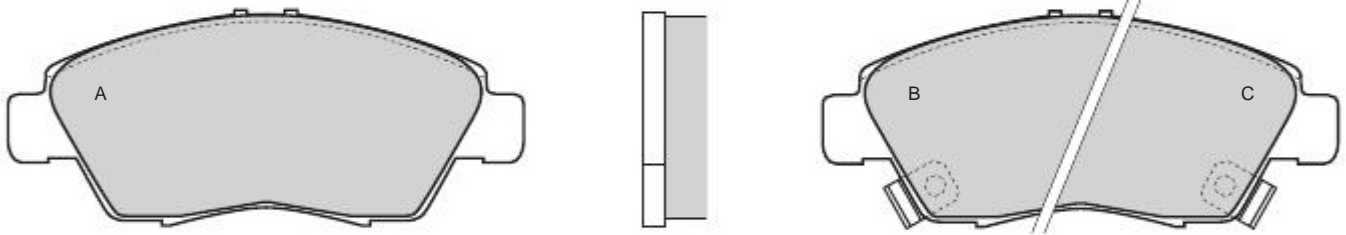



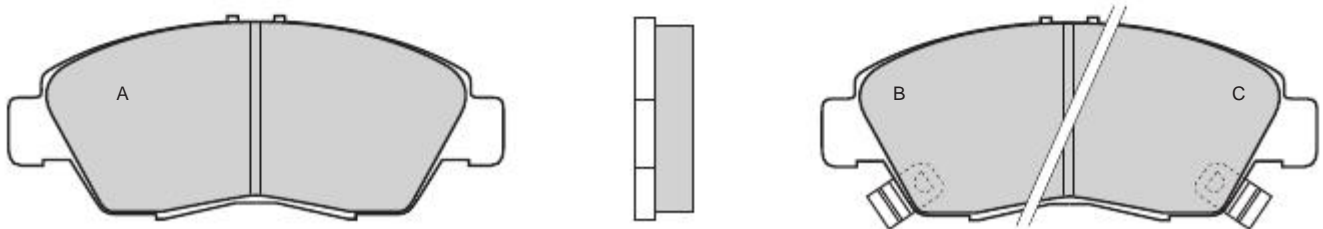



0546	HONDA	AKEBONO	X	136,5	57,8	16,4	2A 1B-1C		
-------------	-------	---------	---	-------	------	------	-------------	--	--



0547	HONDA	AKEBONO	X	131,5	54,5	15	2A 1B-1C		
-------------	-------	---------	---	-------	------	----	-------------	--	--



									
0548	HONDA	AKEBONO	X	89	37	12,6	2A-2B		

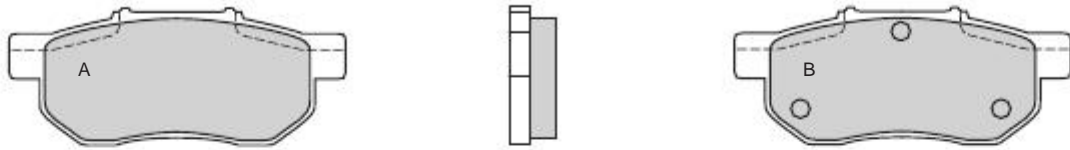



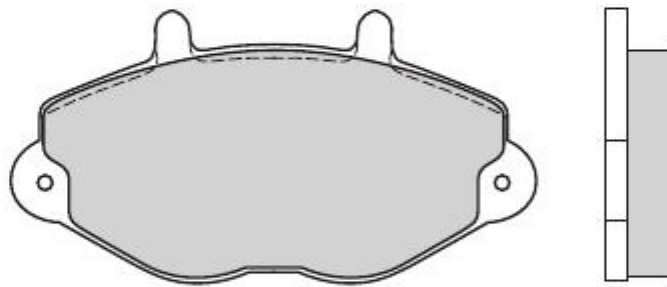



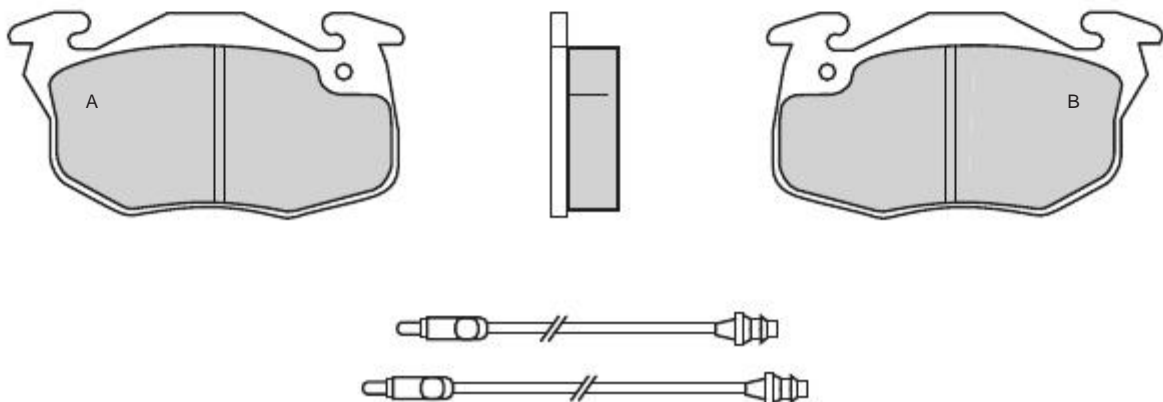

0549	FORD	BENDIX	X		139	72	18,7	4		
------	------	--------	---	--	-----	----	------	---	--	--



0550	CITROEN - PEUGEOT	BENDIX	X		105	55	18	2A-2B	2	2	200 338
------	-------------------	--------	---	--	-----	----	----	-------	---	---	------------

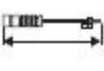

									
0551	CITROEN - PEUGEOT	BENDIX	X	105	55	15	2A-2B	2	200 338

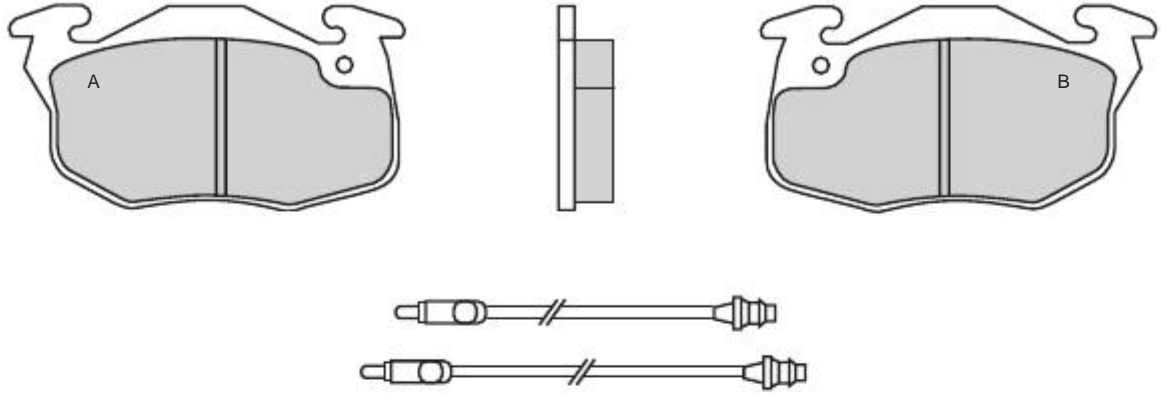



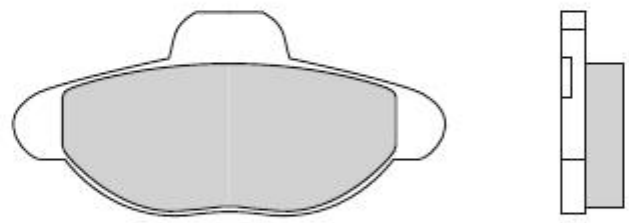



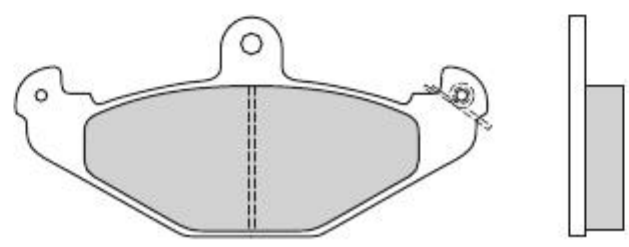



0552	FIAT	BENDIX	X	114,9	54	17	4		
-------------	------	--------	---	-------	----	----	---	--	--



0553	RENAULT	BREMBO	X	125,9	58,4	14,8	4		
-------------	---------	--------	---	-------	------	------	---	--	--



									
0554	VOLKSWAGEN	GIRLING	X	91,4	80	18	4		

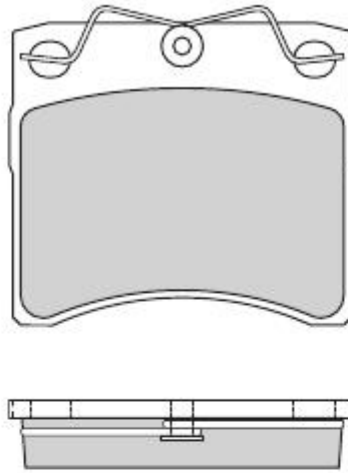



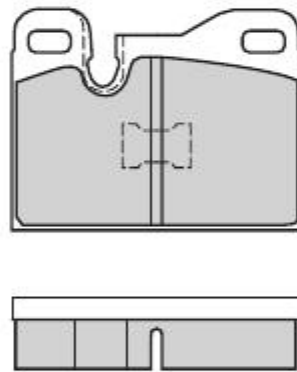



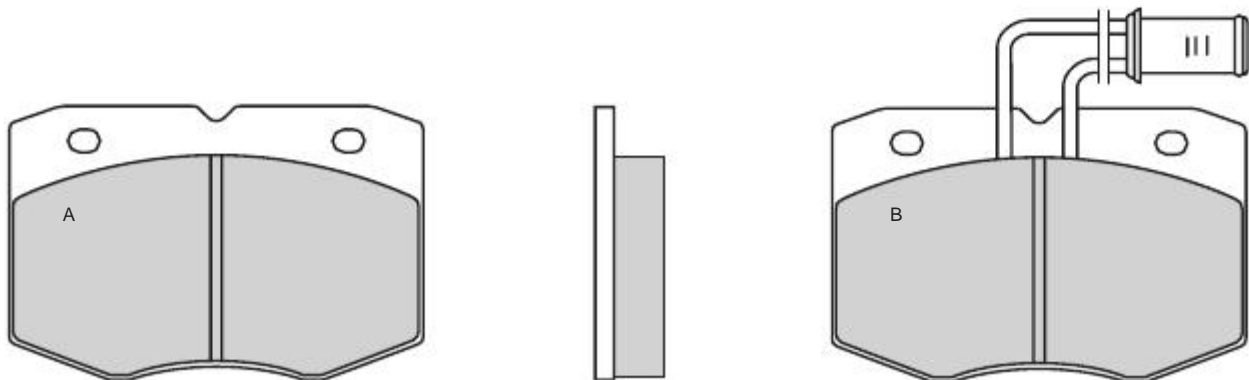

0555	PORSCHE	ATE	X	X	76,8	58,7	18	4	
-------------	----------------	------------	----------	----------	-------------	-------------	-----------	----------	--



0556	FIAT-IVECO	BREMBO	X		109,7	73	18,3	2A-2B	2	170
-------------	-------------------	---------------	----------	--	--------------	-----------	-------------	--------------	----------	------------

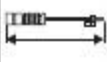

									
0557	RENAULT	GIRLING	X	109,9	67,6	18	2A 1B-1C	2	200

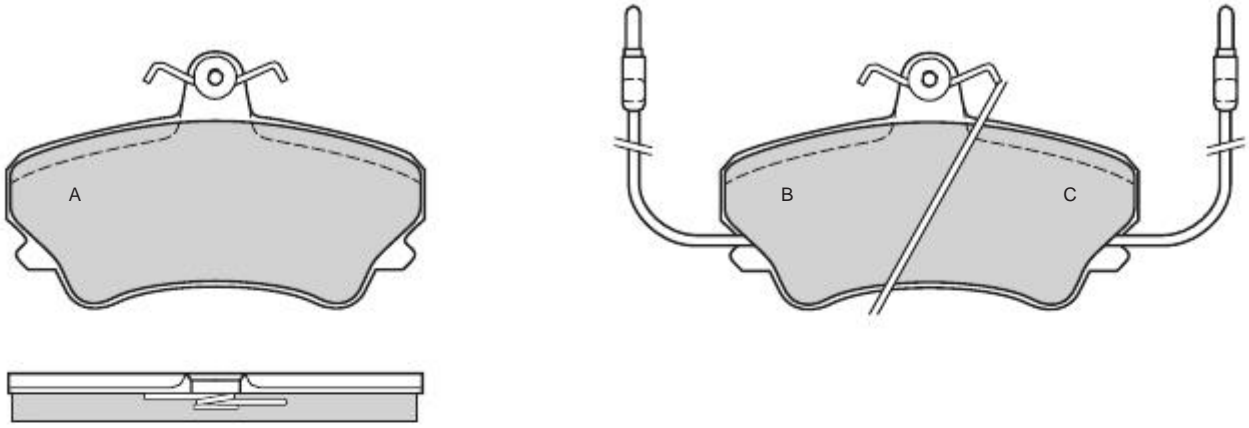



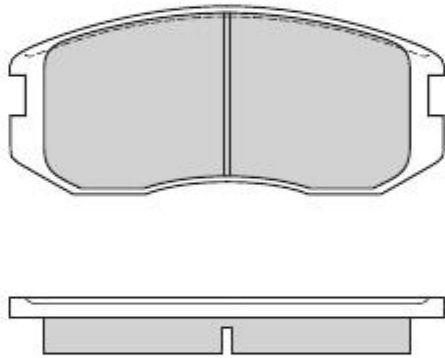



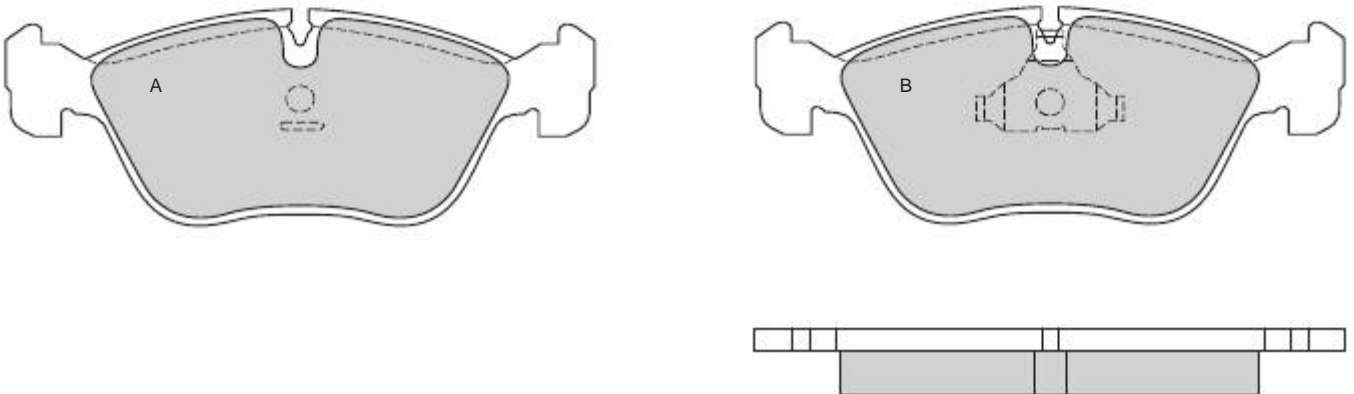

0558	MITSUBISHI - PROTON	SUMITOMO	X	114,2	49,9	15	4		
------	---------------------	----------	---	-------	------	----	---	--	--



0559	VOLVO	ATE	X	156,5	58,5	19	2A-2B		
------	-------	-----	---	-------	------	----	-------	--	--

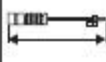

									
0560	NISSAN	SUMITOMO	X	90	45	15	4		

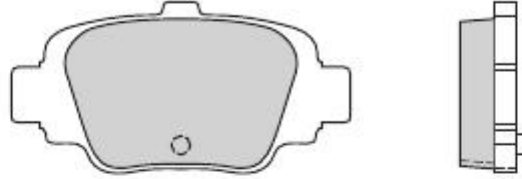



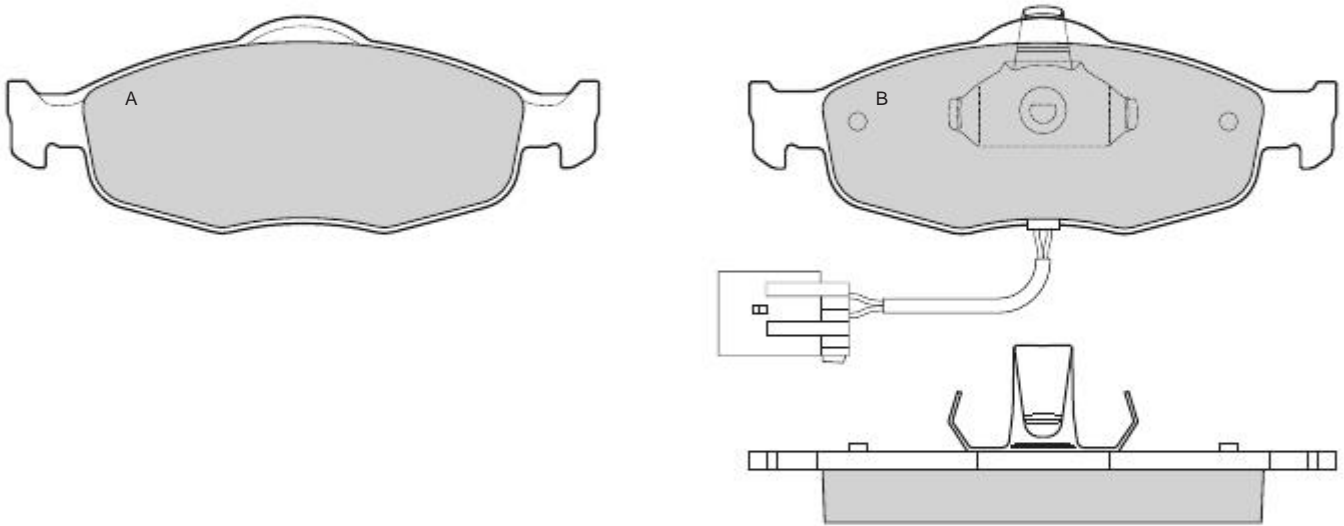



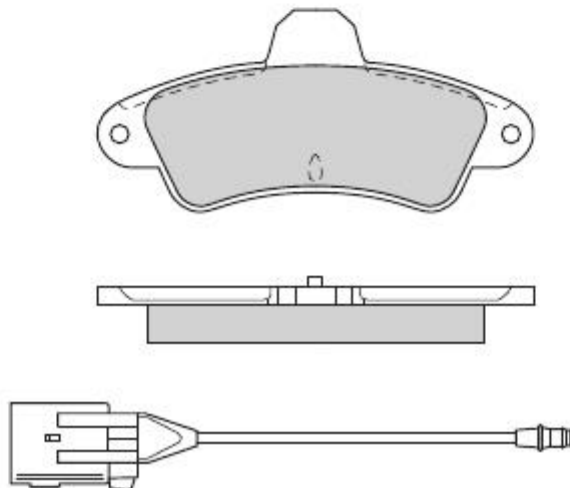

0561	FORD	ATE	X	A 156,3 B 155,2	58,5	18,5	2A-2B	2	225
------	------	-----	---	--------------------	------	------	-------	---	-----



0562	FORD	BENDIX	X	115,8	53,7	15	4	2	150
------	------	--------	---	-------	------	----	---	---	-----

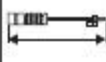

									
0563	NISSAN	AKEBONO	X	120,85	45	15,8	4		

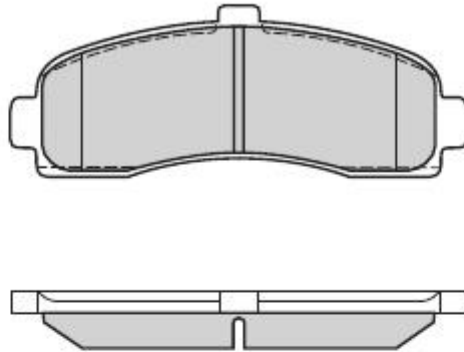



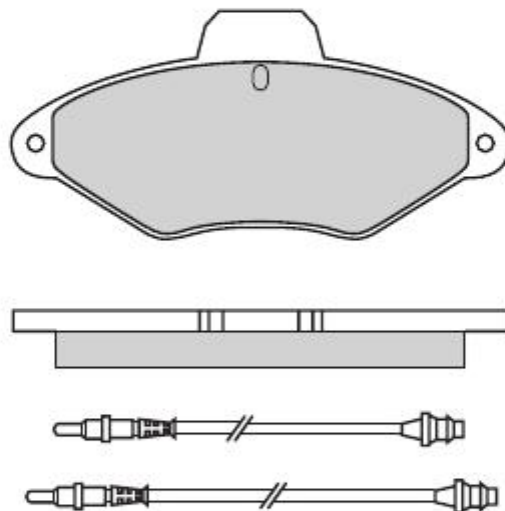



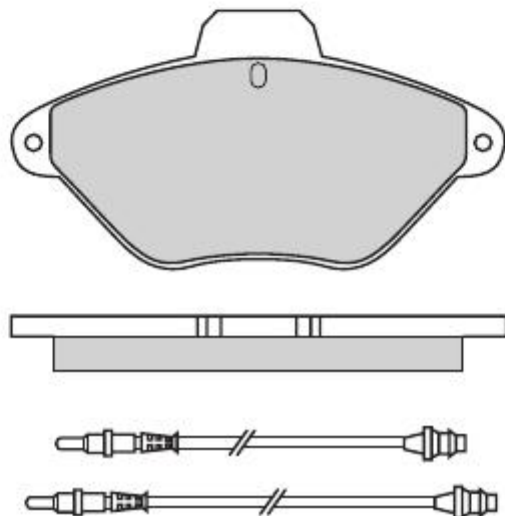

0564	CITROEN	BENDIX	X	131	60,5	16,8	4	2 2	200 370
-------------	---------	--------	---	-----	------	------	---	--------	------------



0565	CITROEN	BENDIX	X	131	68,8	16	4	2 2	200 370
-------------	---------	--------	---	-----	------	----	---	--------	------------

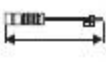

									
0566	MERCEDES	BENDIX	X	145,6	59,2	14	2A-2B		

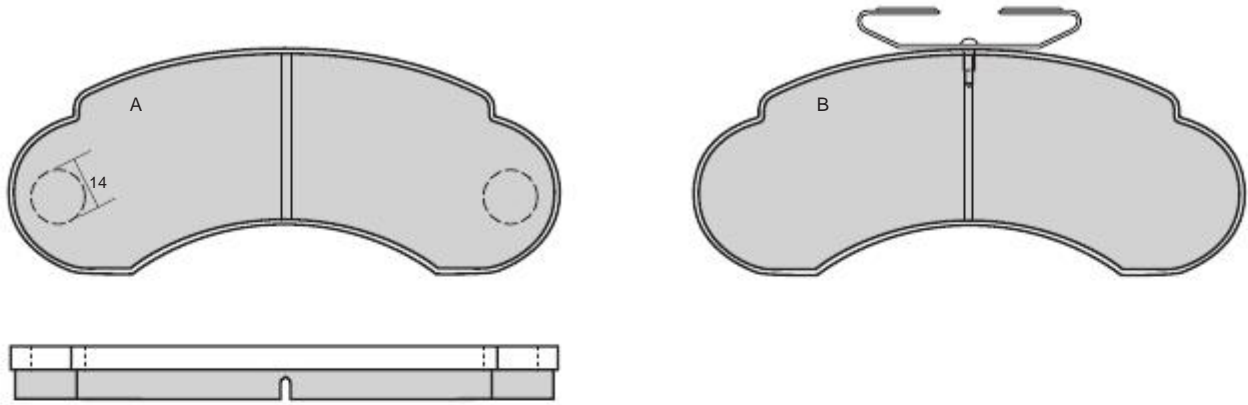



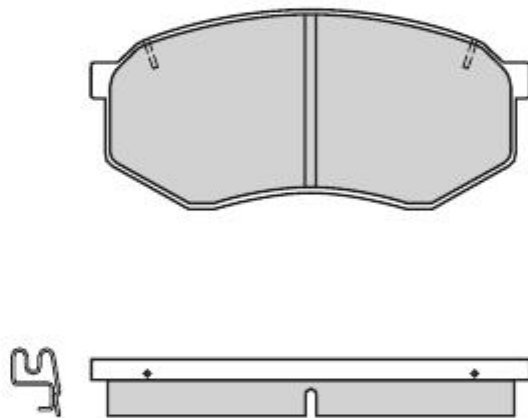



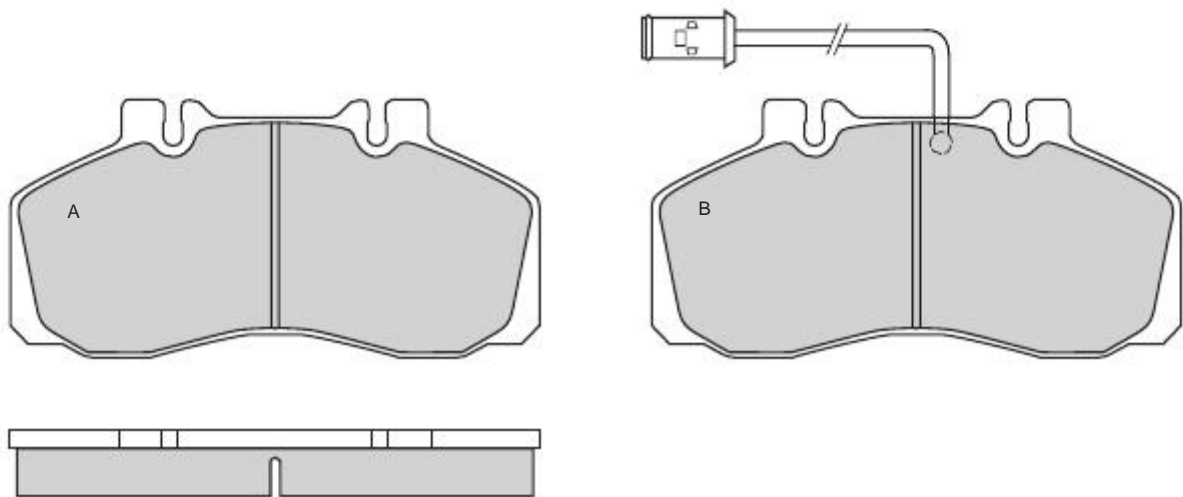

0567	TOYOTA	SUMITOMO	X	116,1	53,4	15,3	4		
------	--------	----------	---	-------	------	------	---	--	--



0568	FIAT	PERROT	X	175,1	85,6	21,7	2A-2B	2	510
------	------	--------	---	-------	------	------	-------	---	-----

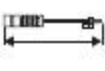

									
0569	NISSAN	SUMITOMO	X	137,2	53,2	17	2A 1B-1C		

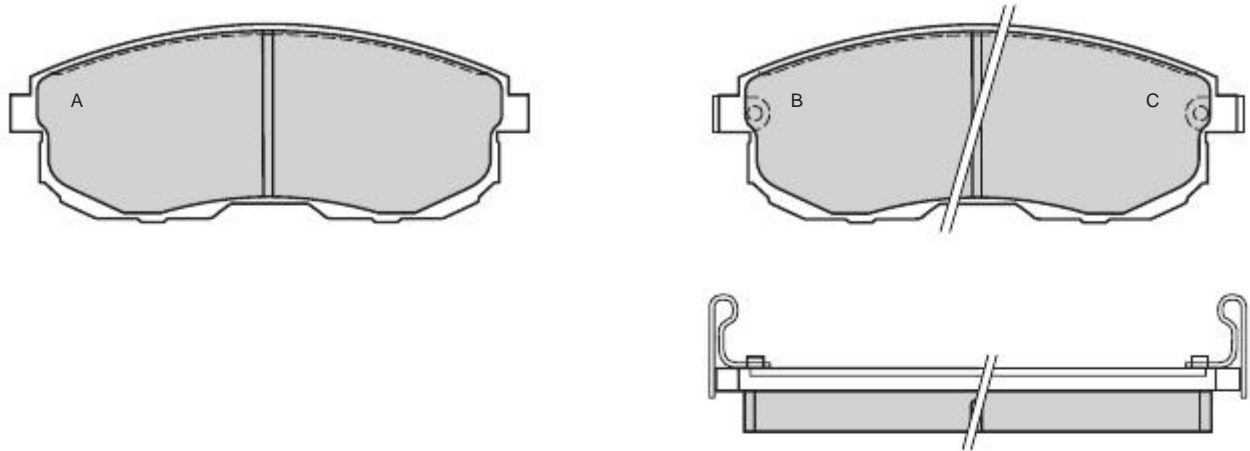



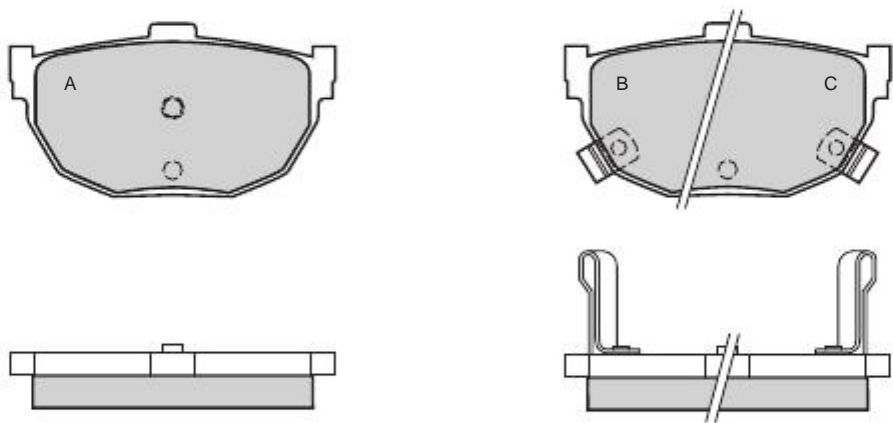



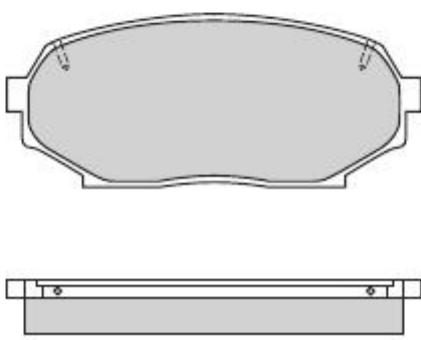

0570	NISSAN	SUMITOMO	X	85,4	45,9	14	2A 1B-1C		
-------------	--------	----------	---	------	------	----	-------------	--	--



0571	MAZDA	SUMITOMO	X	110,1	46,1	14,4	4		
-------------	-------	----------	---	-------	------	------	---	--	--

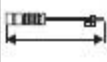

									
0572	NISSAN	SUMITOMO	X	137,2	54,7	16,7	2A-2B		

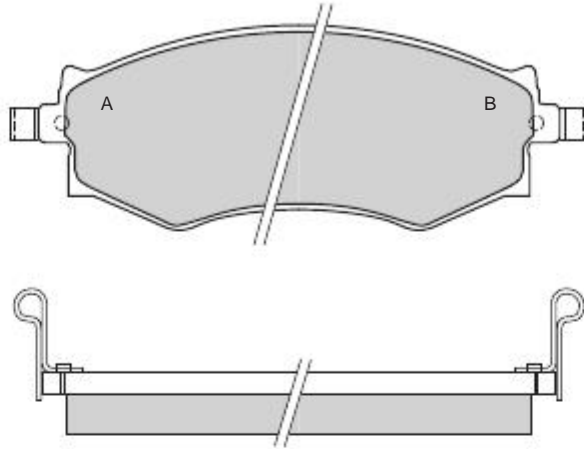



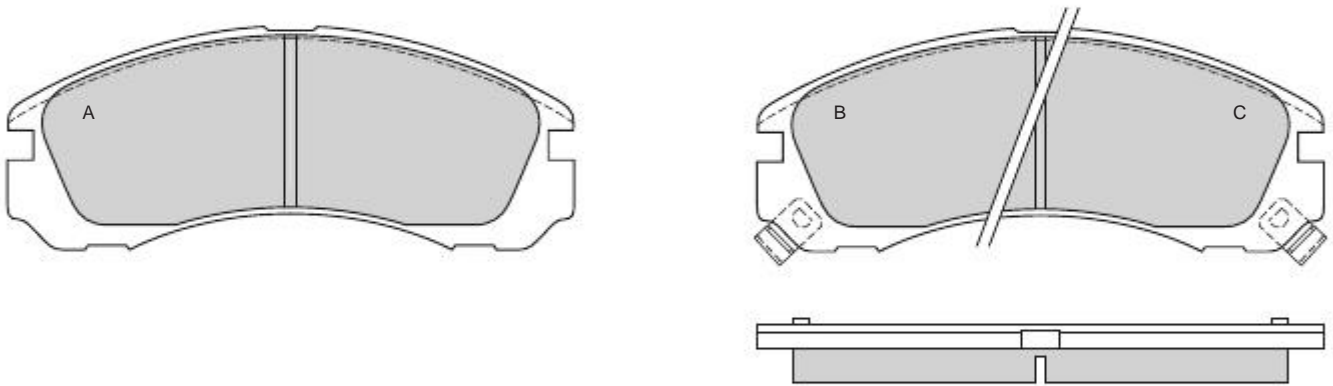



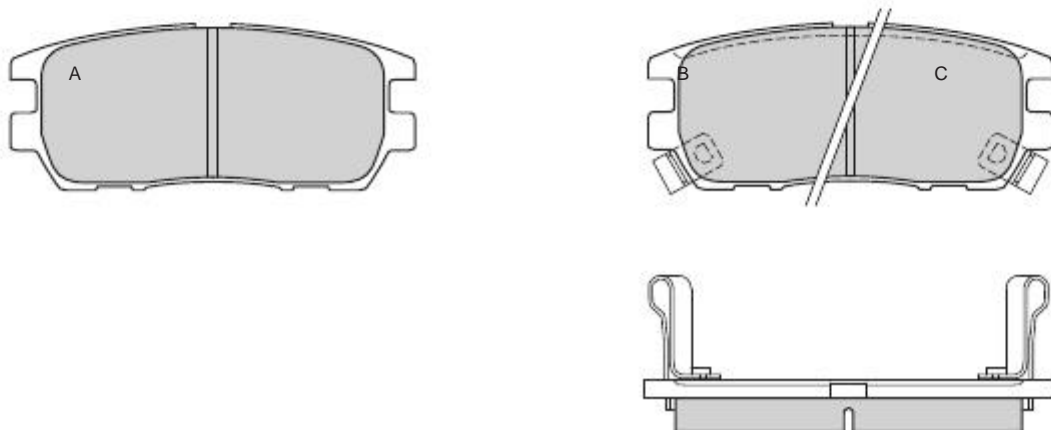



0573	MITSUBISHI - PLYMOUTH	AKEBONO	X	149,9	58,7	15,7	2A 1B-1C		
-------------	-----------------------	---------	---	-------	------	------	-------------	--	--



0574	MITSUBISHI	AKEBONO	X	107,8	43,8	14	2A 1B-1C		
-------------	------------	---------	---	-------	------	----	-------------	--	--



									
0575	NISSAN	AKEBONO	X	114,8	51	15,9	2A 1B-1C		

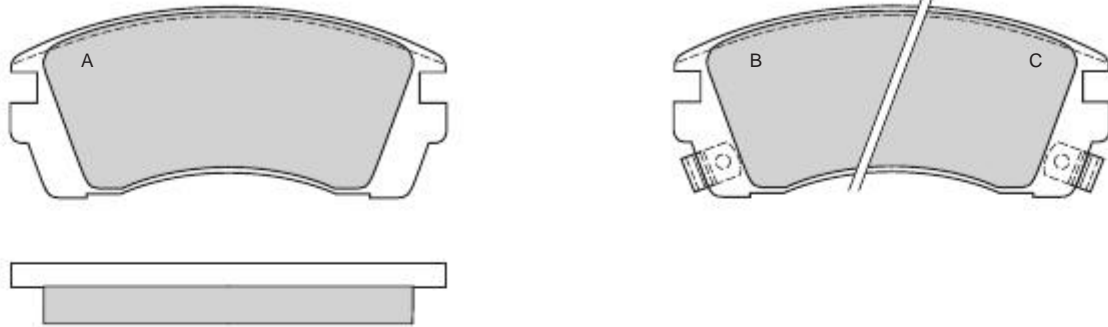



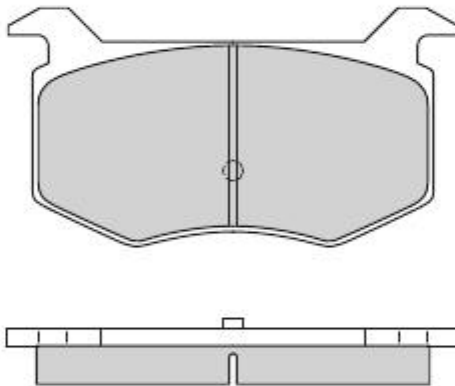



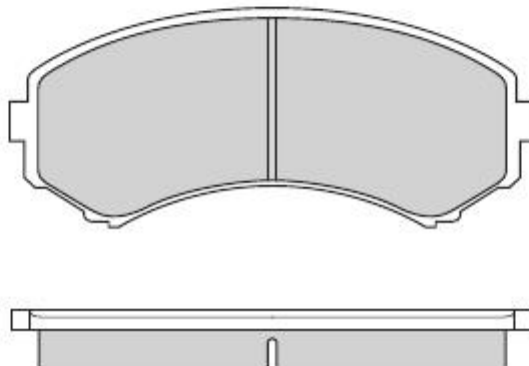



0576	LADA	SKODA	X	119,3	63,3	15	4		
-------------	------	-------	---	-------	------	----	---	--	--



0577	MAZDA	SUMITOMO	X	139,1	58,5	16,8	4		
-------------	-------	----------	---	-------	------	------	---	--	--



									
0578	MAZDA	SUMITOMO	X	139,2	60,3	16,8	4		

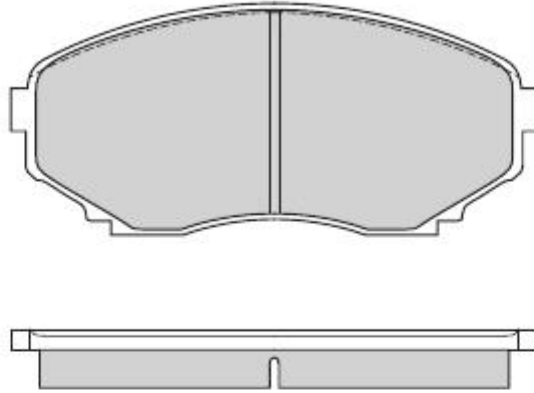



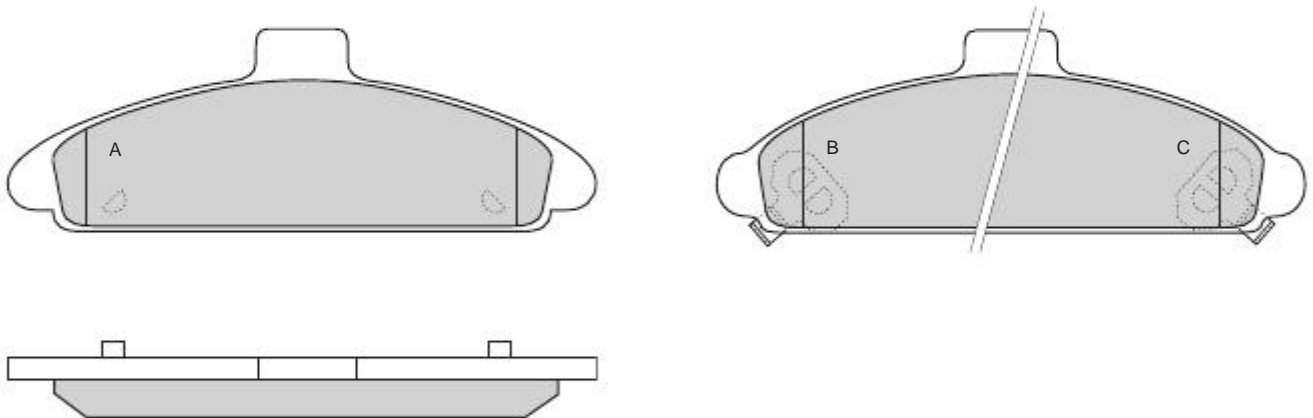



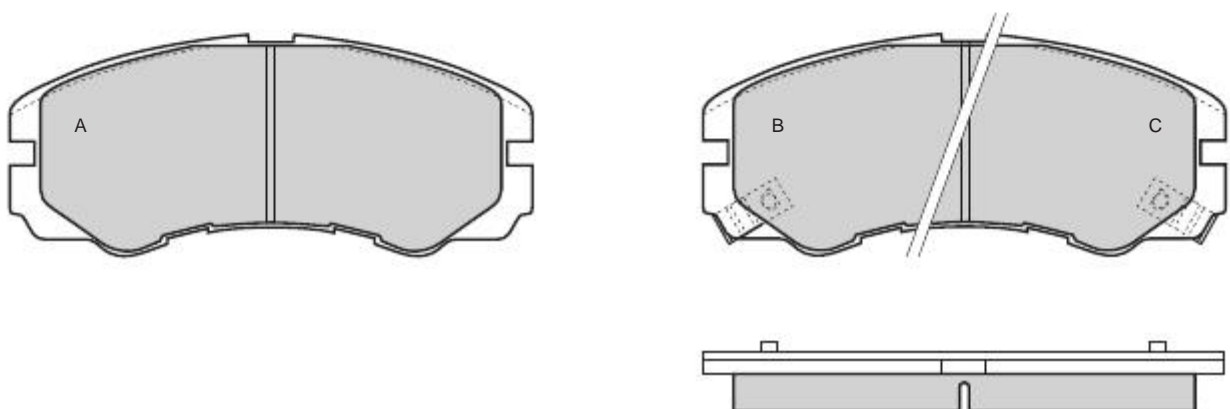



0579	HYUNDAI	AKEBONO	X	155,6	53,6	16	2A 1B-1C		
-------------	---------	---------	---	-------	------	----	-------------	--	--



0580	ISUZU - OPEL	SUMITOMO	X	137,9	58,6	16,5	2A 1B-1C		
-------------	--------------	----------	---	-------	------	------	-------------	--	--



									
0581	ISUZU - OPEL - VAUXHALL	SUMITOMO	X	109,7	42,6	15,8	2 ^A	1B-1C	

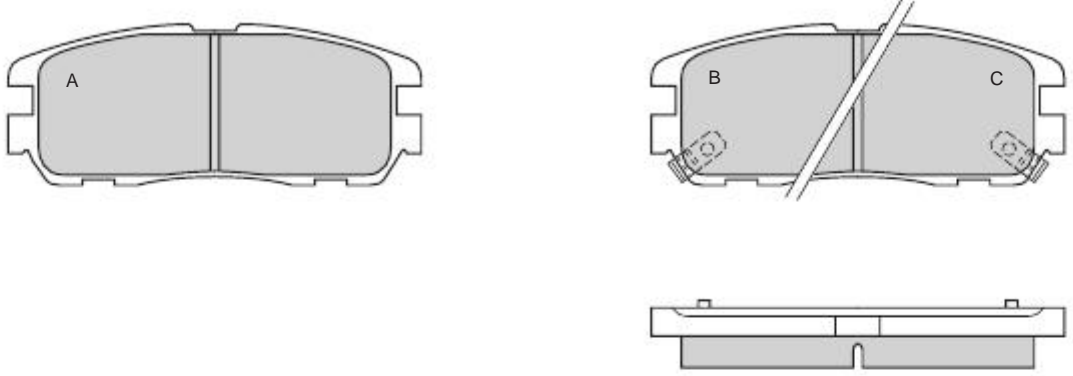



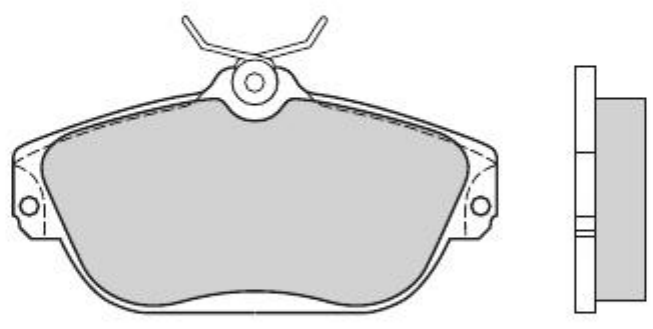



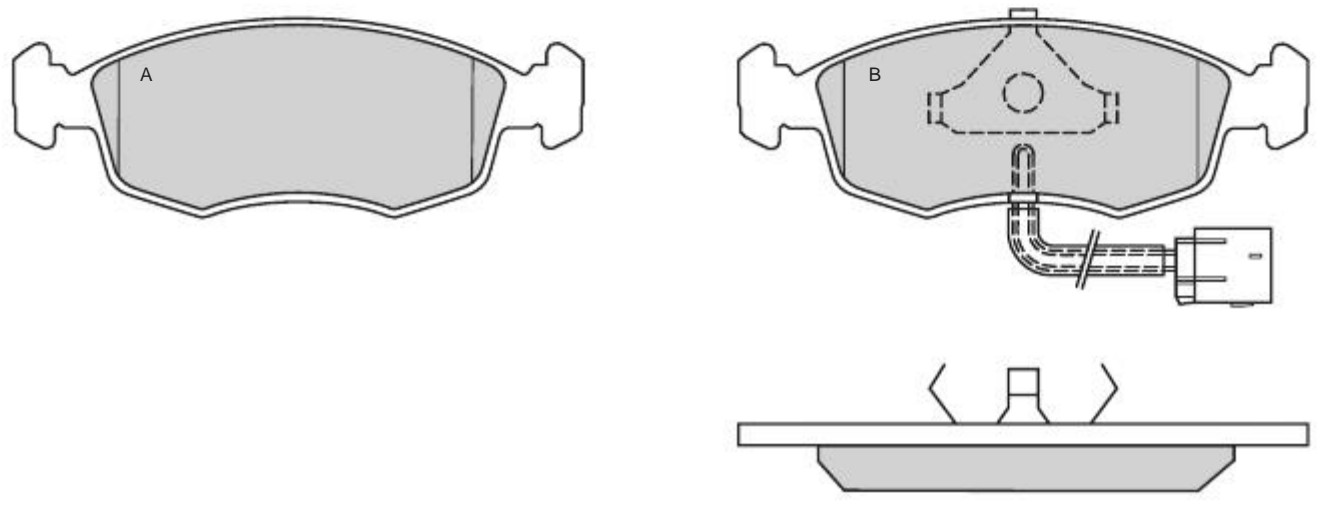

0582	VOLVO	GIRLING	X	129,1	64,8	18	4		
------	-------	---------	---	-------	------	----	---	--	--



0583	FORD	ATE	X	151,4	52,4	17,5	2A-2B	2	260
------	------	-----	---	-------	------	------	-------	---	-----

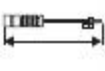

									
0584	OPEL	ATE	X	141,4	48,3	16,5	2A-2B		

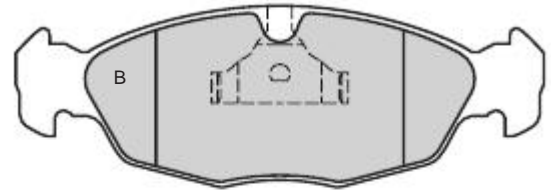
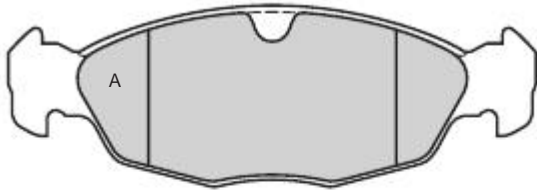



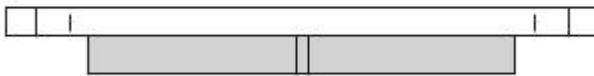
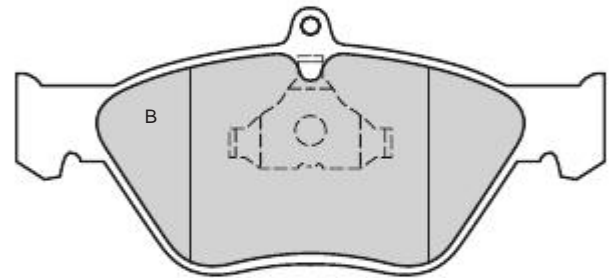
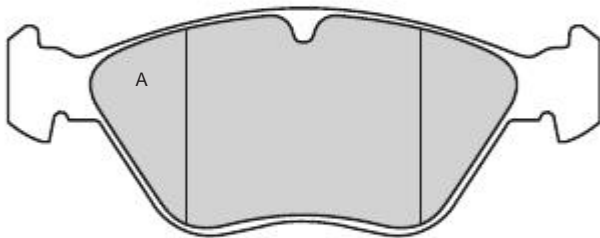



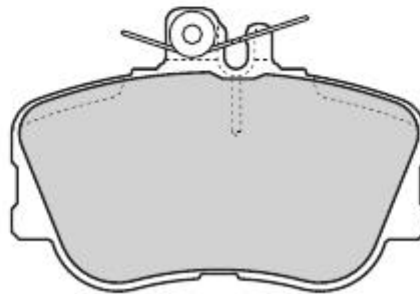

0585	OPEL - SAAB - VAUXHALL	ATE	X	A 156,4 B 155,3	A 60,7 B 70,6	18	2A-2B		
-------------	------------------------	-----	---	--------------------	------------------	----	-------	--	--



0586	MERCEDES	GIRLING	X	109,5	74,8	19,5	4		
-------------	----------	---------	---	-------	------	------	---	--	--

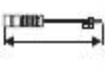

									
0587	ALFA ROMEO FIAT - LANCIA	GIRLING	X	129,9	56,6	19,3	2A-2B	2	220

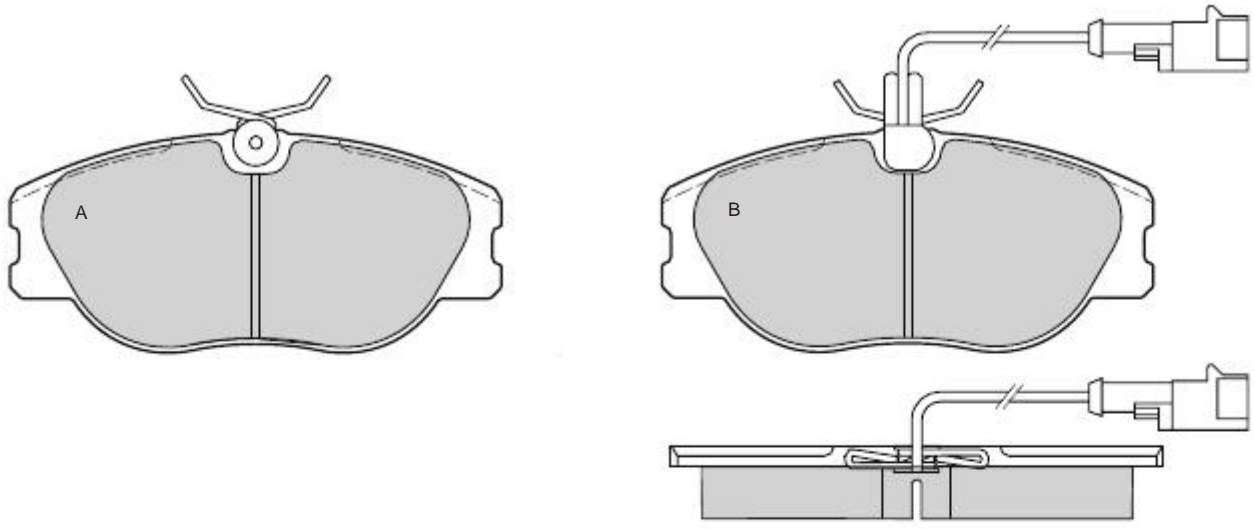



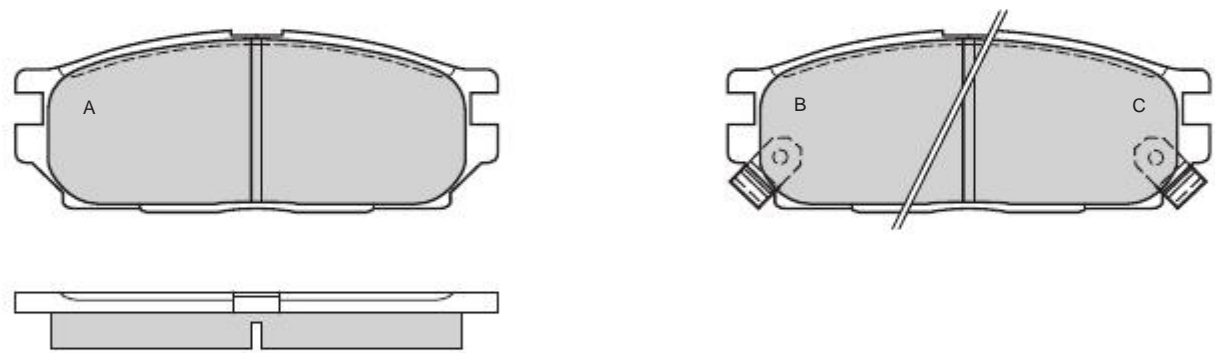



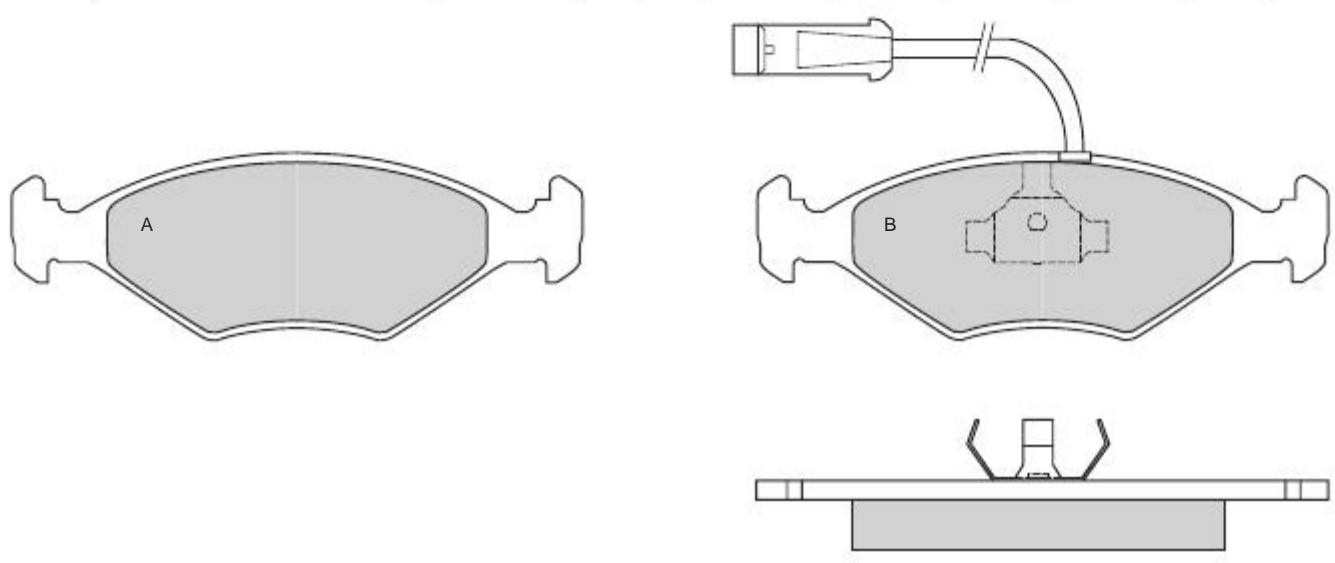

0588	MITSUBISHI	LUCAS	X	127,8	48,2	15,4	2A 1B-1C		
------	------------	-------	---	-------	------	------	-------------	--	--



0589	FIAT	ATE	X	151,4	50	18	2A-2B	2	250
------	------	-----	---	-------	----	----	-------	---	-----

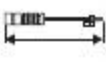

Reference in this Catalogue to other manufacturers and to part numbers and other descriptions are for identification purposes only, because the above **DISC BRAKE PADS** are **NOT ORIGINAL** but with these interchangeable

									
0590	RENAULT	GIRLING	X	100	64,7	18	4	2	200

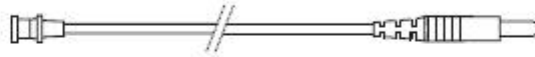
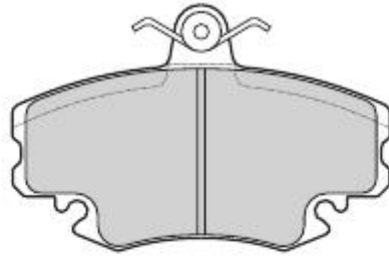



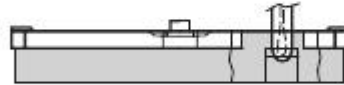
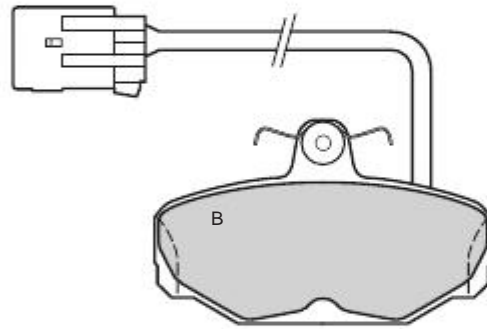
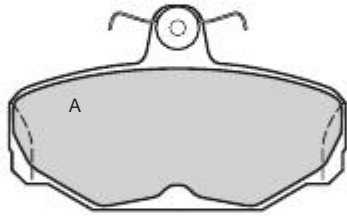





0591	FORD	GIRLING	X	89,8	54	13,7	2A-2B	2	240
------	------	---------	---	------	----	------	-------	---	-----



0592	FORD	ATE	X	A 156,4 B 155,2	58,5	18,5	2A-2B		
------	------	-----	---	--------------------	------	------	-------	--	--

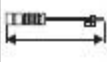

									
0593	FORD	BENDIX	X	115,8	53,7	15	4		

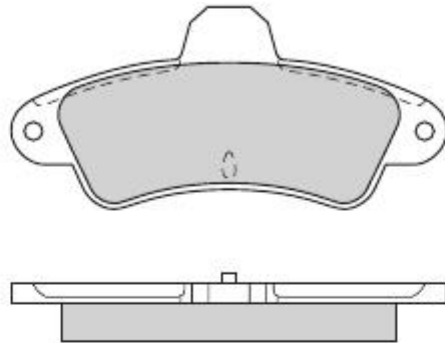



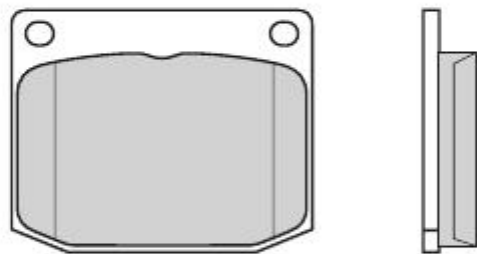



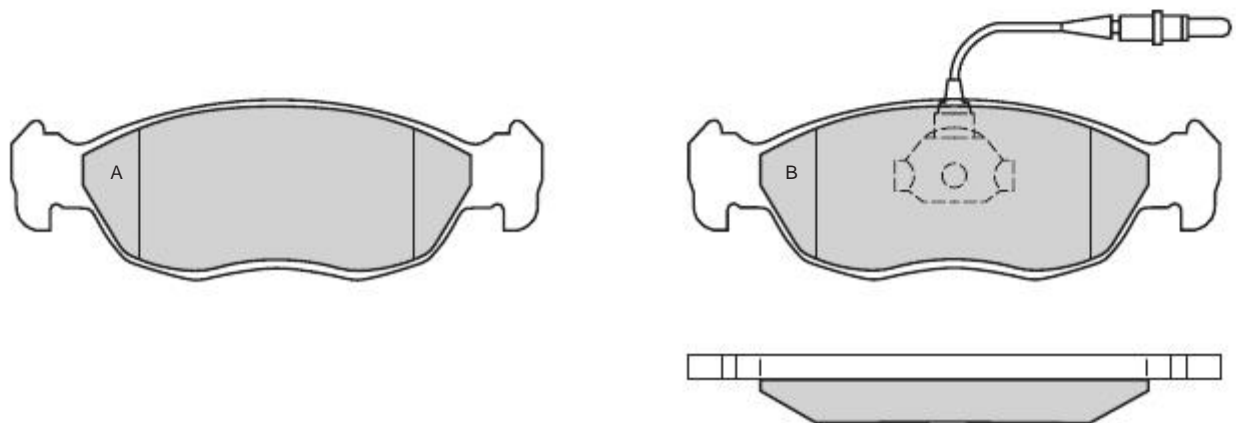



0594	SAAB	GIRLING	X	78,5	64,5	14,5	4		
------	------	---------	---	------	------	------	---	--	--



0595	PEUGEOT	ATE	X	A 141,5 B 140,25	A 47,6 B 47,45	18	2A-2B	2	285
------	---------	-----	---	---------------------	-------------------	----	-------	---	-----



									
0596	SUZUKI	AKEBONO	X	109,3	44	14	4		

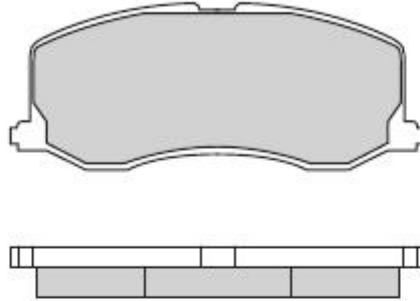



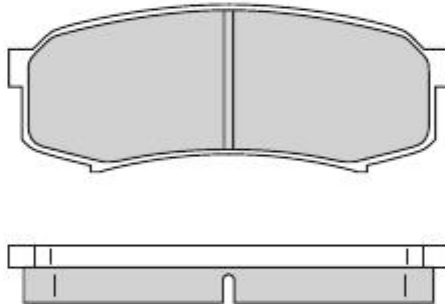



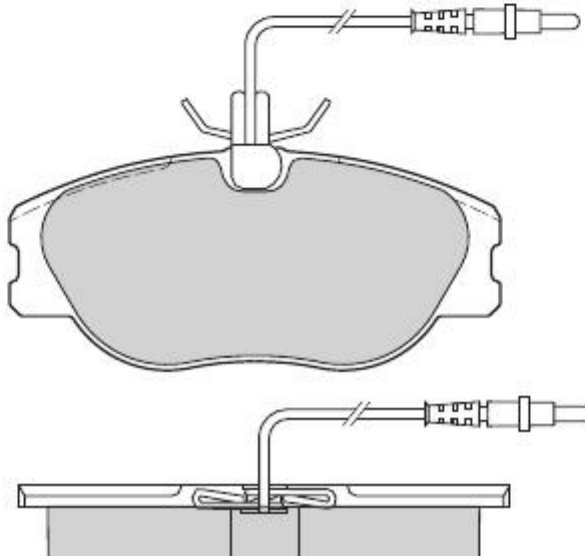

0597	TOYOTA	SUMITOMO	X	116,2	44	15,2	4		
-------------	--------	----------	---	-------	----	------	---	--	--



0598	FIAT - LANCIA - PEUGEOT	GIRLING	X	129,9	56,6	19,3	4	4	220
-------------	-------------------------	---------	---	-------	------	------	---	---	-----

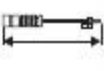

									
0599	FIAT - LANCIA PEUGEOT - JAGUAR	ATE	X	123	43	17	2A-2B		

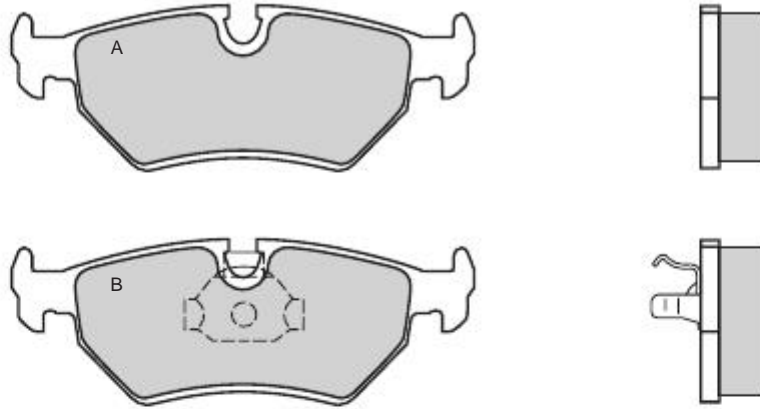



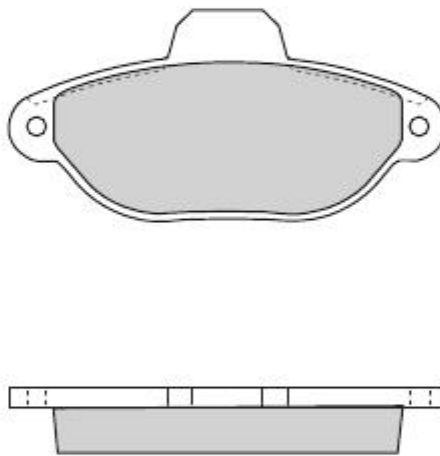



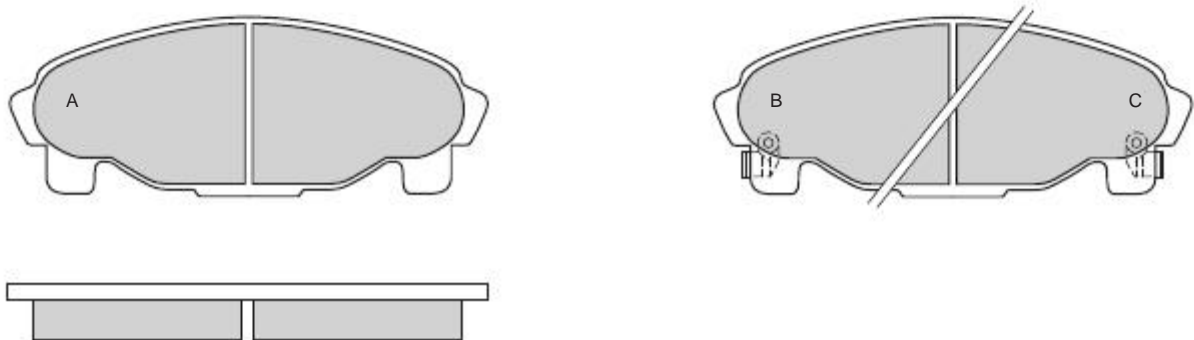

0600	FIAT	BENDIX	X	114,9	55,6	17	4		
------	------	--------	---	-------	------	----	---	--	--



0601	DAIHATSU	AKEBONO	X	127	47	15,6	2A 1B-1C		
------	----------	---------	---	-----	----	------	-------------	--	--

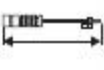

									
0602	DAIHATSU	AKEBONO	X	101,6	42,5	11,9	4		

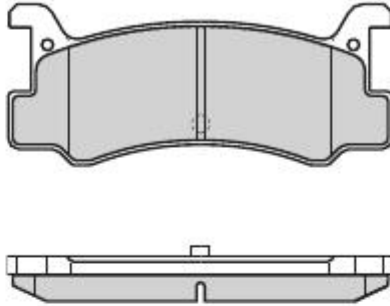

0603	CITROEN	GIRLING	X	89,95	63	17,7	2A-2B	4	350
-------------	---------	---------	---	-------	----	------	-------	---	-----

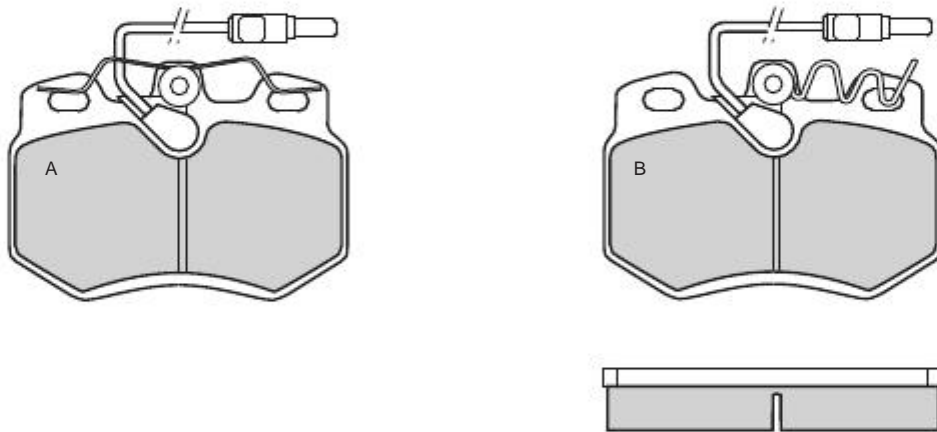

0604	CITROEN	GIRLING	X	90	63	17,7	4	4	370
-------------	---------	---------	---	----	----	------	---	---	-----

