

5219		CRL	X	177	74	22,5	1		

BONSER
CASE
CATERPILLAR
FURUKAW
JCB
KAWASAKI
VOLVO

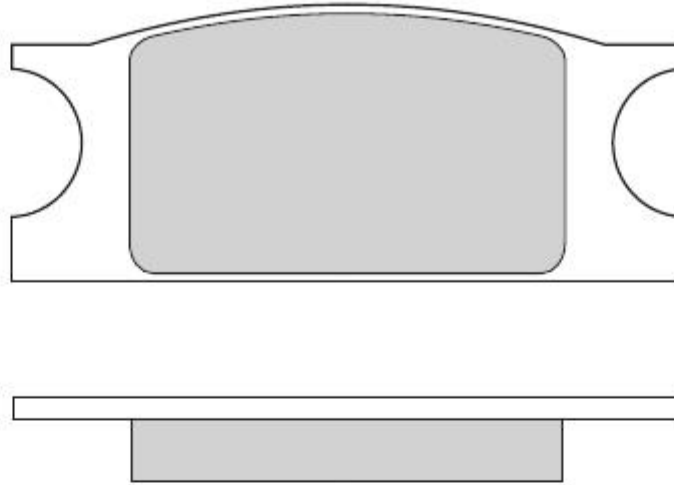

5220

CRL X 277,8 85,7 22,2 1

AVELING BARFORD
BOLINDER MUNKTEL
CASE
CATERPILLAR
CLARK MICHIGAN
EIMCO
FAUN FRISCH
FIAT
FRISCH SHOVEL
FURUKAWA
GROOT MODEL
JCB
KAWASAKI
VOLVO

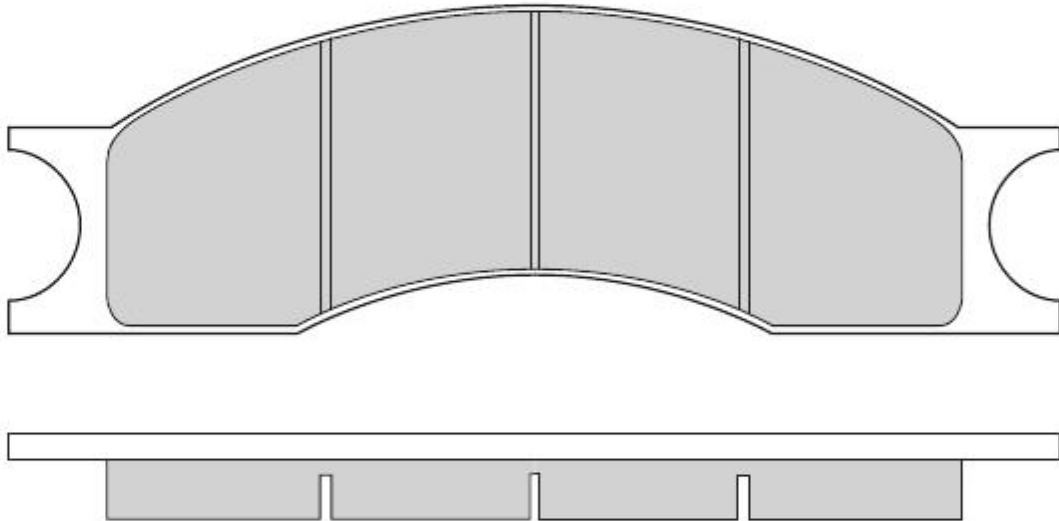







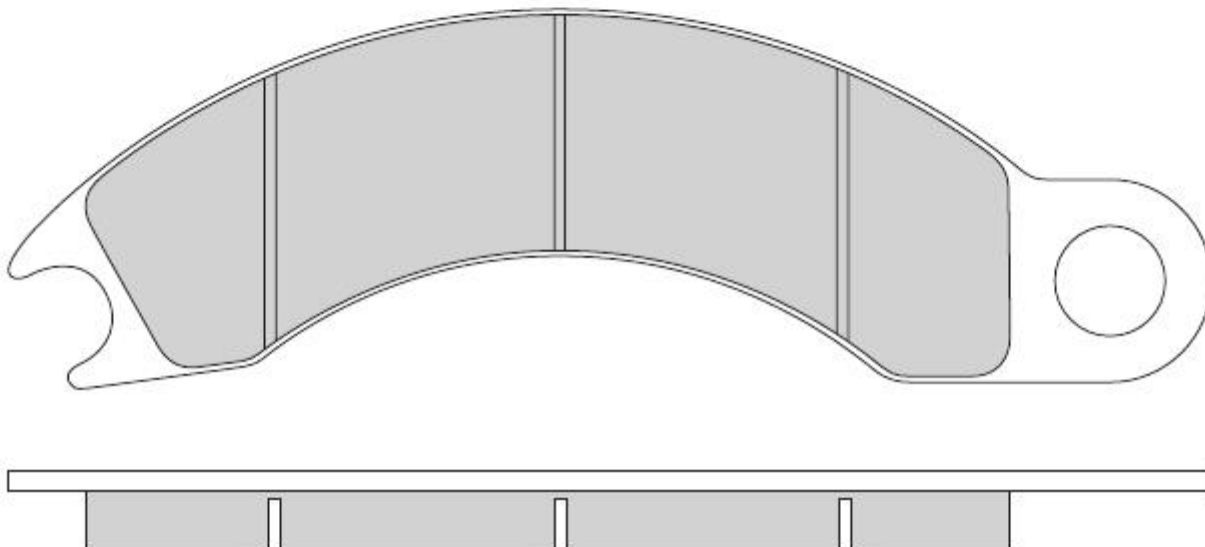

5221

CATERPILLAR - EUCLID
KOMATSU - WAGNER

CRL X 397 125 28 1

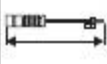

									
5222	CATERPILLAR - EUCLID KOMATSU - WAGNER	CRL	X	397	125	28	1		

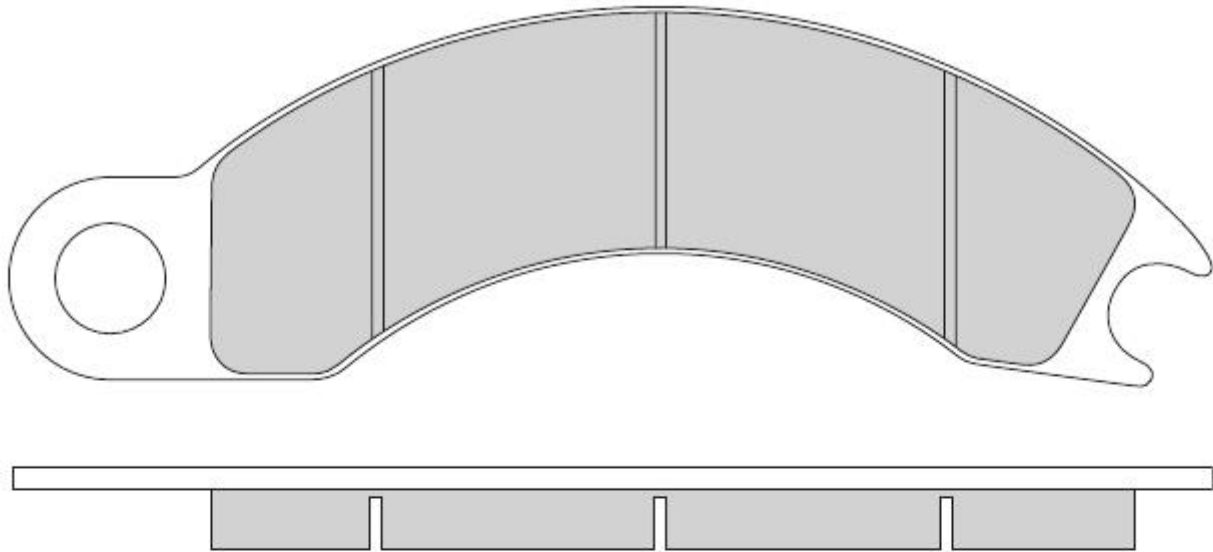



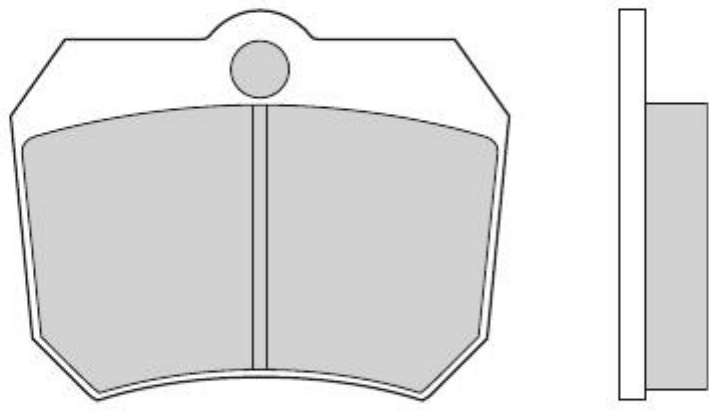



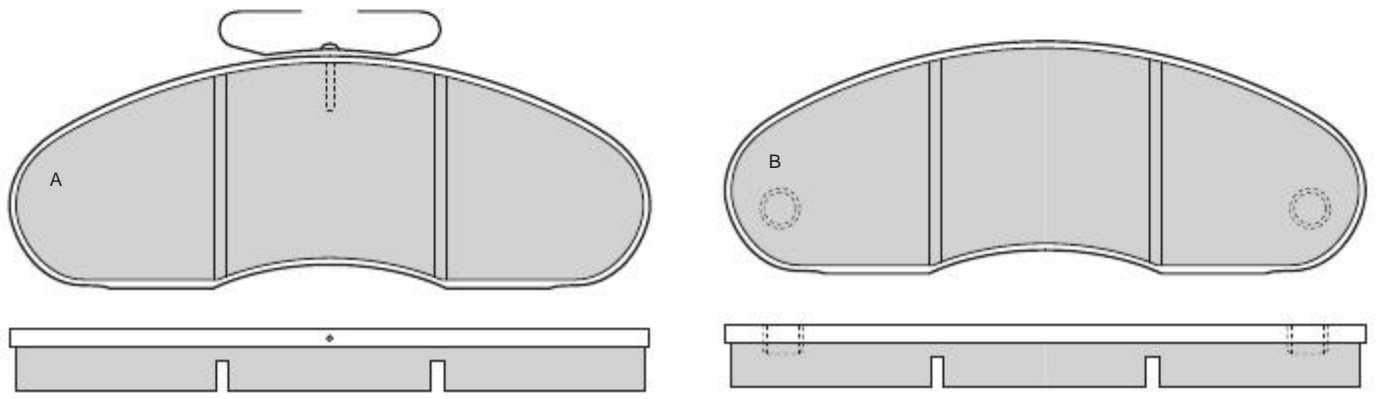

5223	PERROT - MASSEY FERGUSON FRISCH SHOVEL	PERROT	X	132,2	103,8	24	4		
-------------	---	---------------	----------	--------------	--------------	-----------	----------	--	--



5224	MERCEDES	BENDIX	X	166,5	62	17	2A-2B		
-------------	-----------------	---------------	----------	--------------	-----------	-----------	--------------	--	--

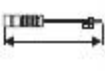

									
5225	MENARINI - ROSSI	BREMBO	X	117	83	19	4		

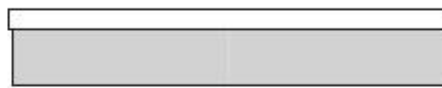
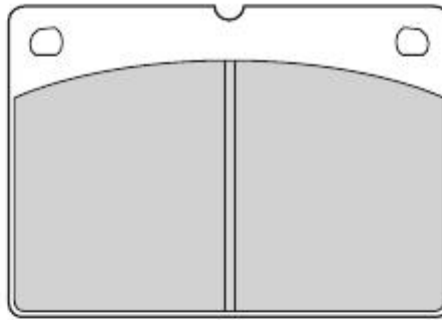



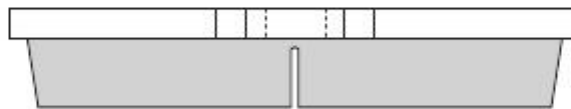
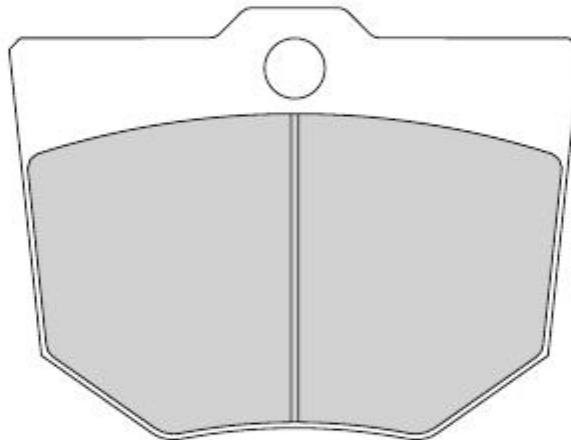



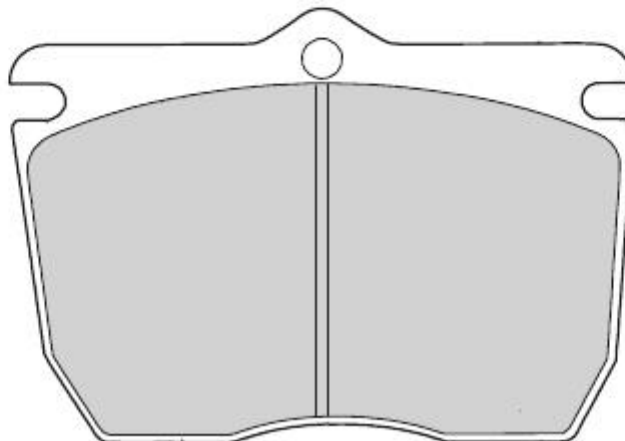

5226	HANOMAG - LIENHERR	PERROT	X	151,2	114,4	26	4		
-------------	--------------------	--------	---	-------	-------	----	---	--	--



5227	HANOMAG - INBUS KÄSSBOHRER - MENARINI	PERROT	X	162,2	111,3	27,5	8		
-------------	--	--------	---	-------	-------	------	---	--	--

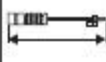

									
5229		PERROT	X		136,4	103,8	23,8	4	

CASE
FRISCH SHOVEL
INTERNATIONAL HARVESTER
MASSEY FERGUSON

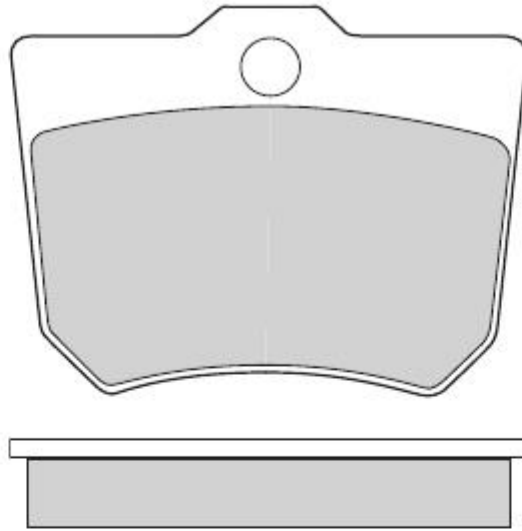



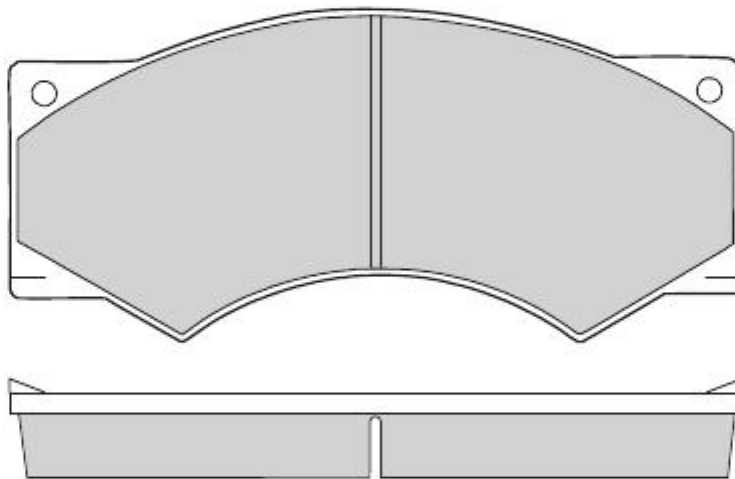



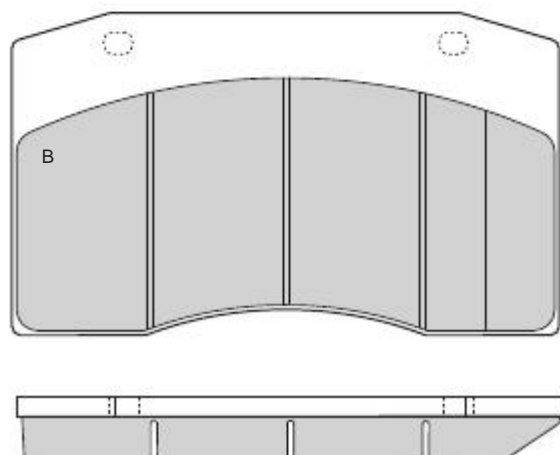
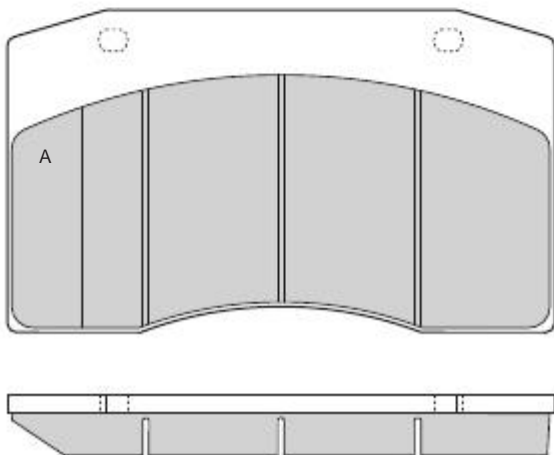

5231	DAF	PERROT	X		191,1	87,1	23	4	
-------------	-----	--------	---	--	-------	------	----	---	--



5232	IVECO	PERROT	X		179,6	106	20	4A-4B	
-------------	-------	--------	---	--	-------	-----	----	-------	--

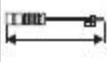

									
5233	CATERPILLAR	CRL	X	326	102	28	2A-2B		

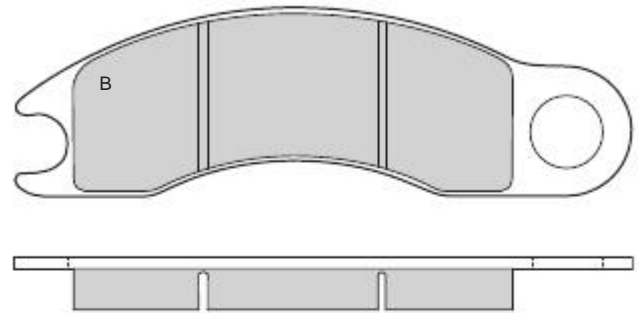
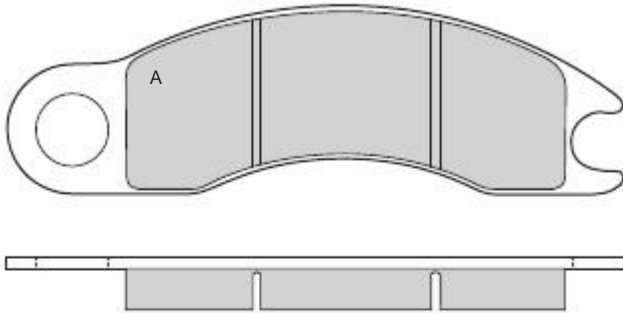

25%



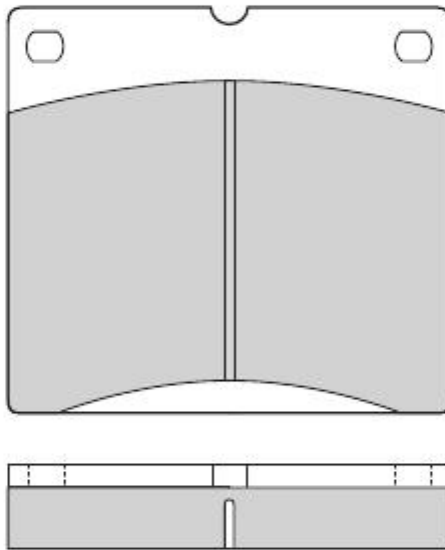





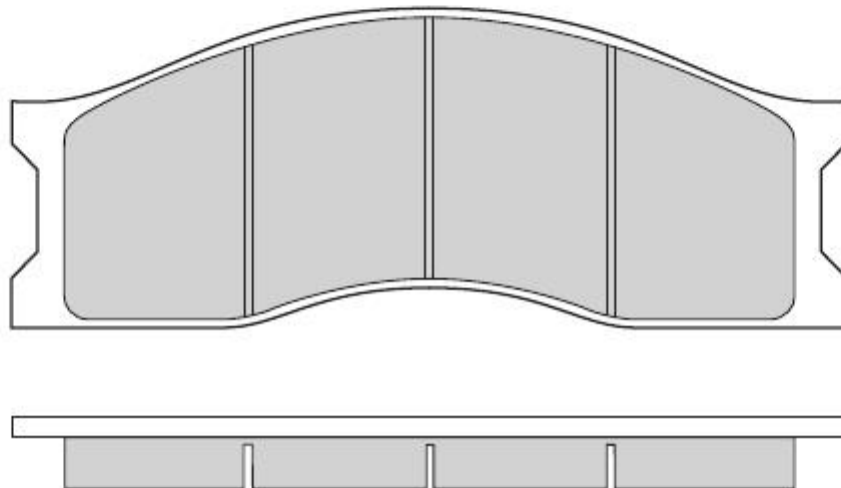

5234	MENARINI	BREMBO	X	117,5	107	22	4		
------	----------	--------	---	-------	-----	----	---	--	--



5235		ROCKWELL	X	276	104	24	4		
------	--	----------	---	-----	-----	----	---	--	--

ALBARET
 AVELING BARFORD
 CASE
 CATERPILLAR
 CLARK MICHIGAN
 KOCKUM
 MICHIGAN
 VOLVO



									
5236	DAF - LEYLAND	PERROT	X	191,1	87,1	23	2A-2B	2	450

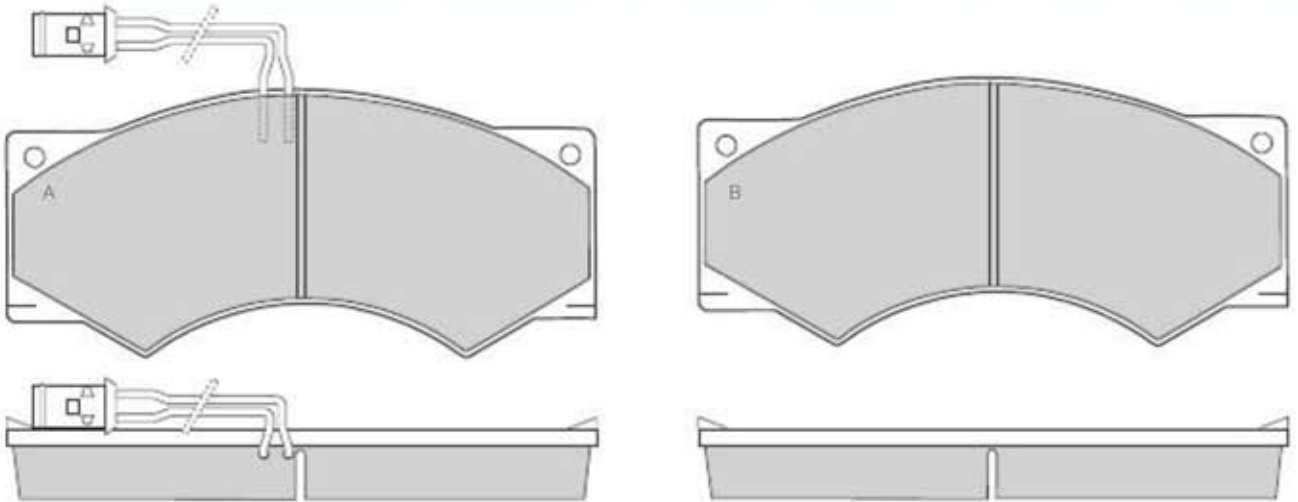



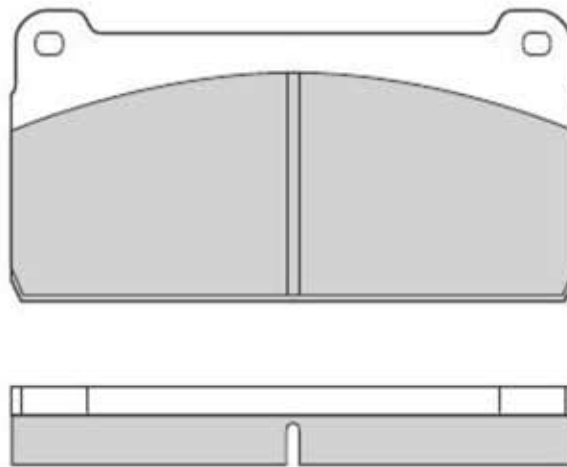



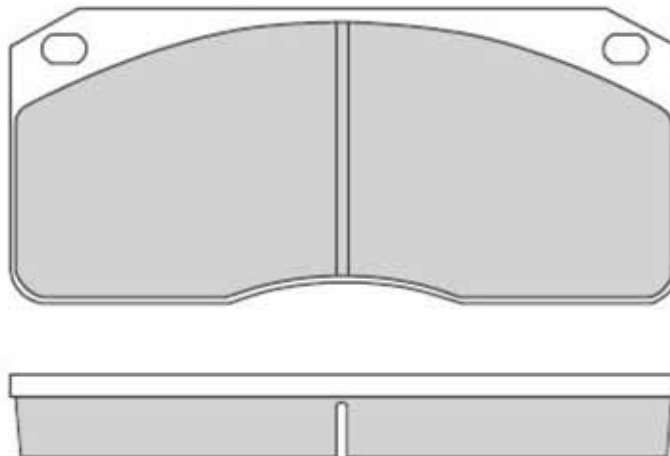



5237	MERCEDES	ATE	X	149,8	78,5	21	4		
------	----------	-----	---	-------	------	----	---	--	--



5238	VOLVO	GIRLING	X	X	175,3	78,5	22	4	
------	-------	---------	---	---	-------	------	----	---	--



									
5239	VOLVO	GIRLING	X	175,3	78,5	22	2A- 2B	2	500

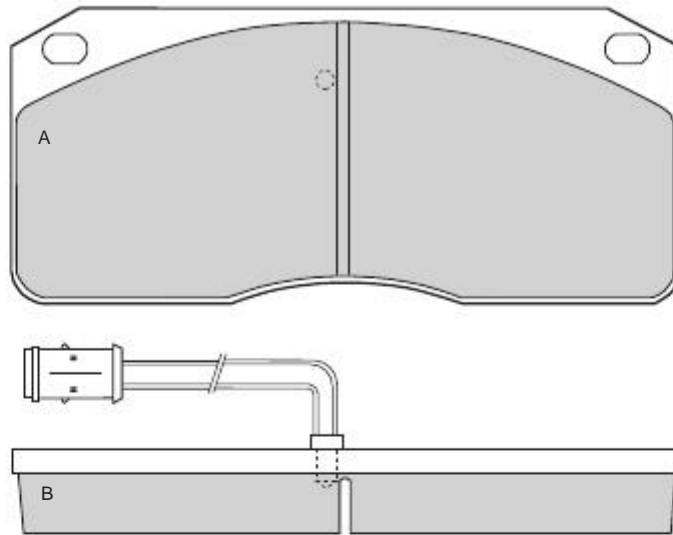



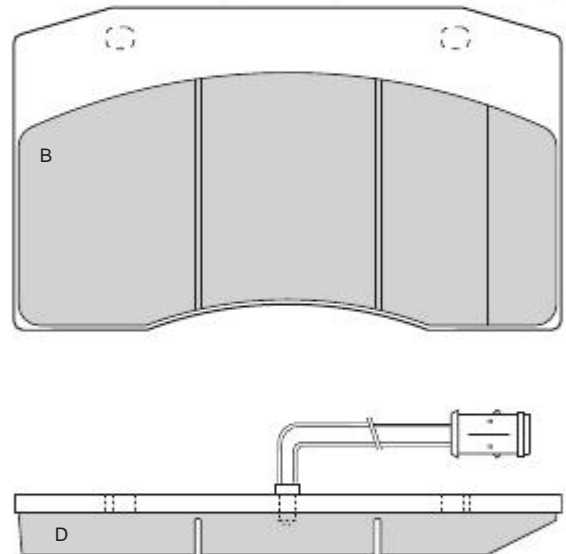
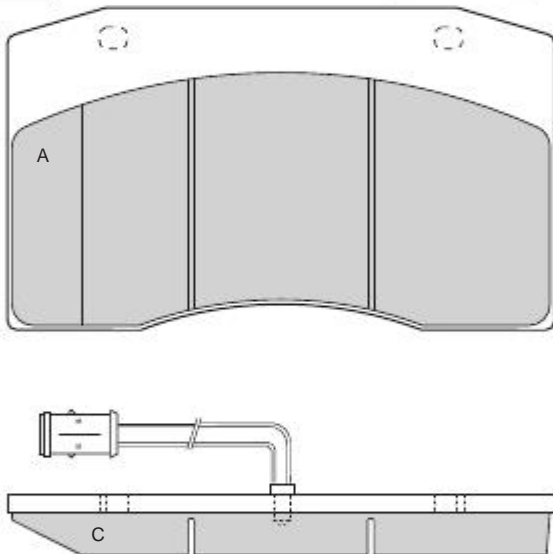



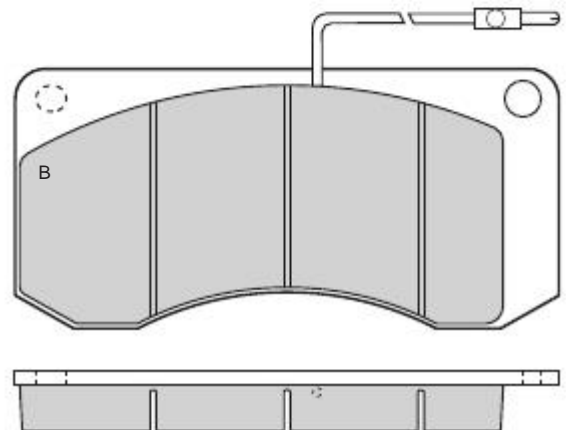
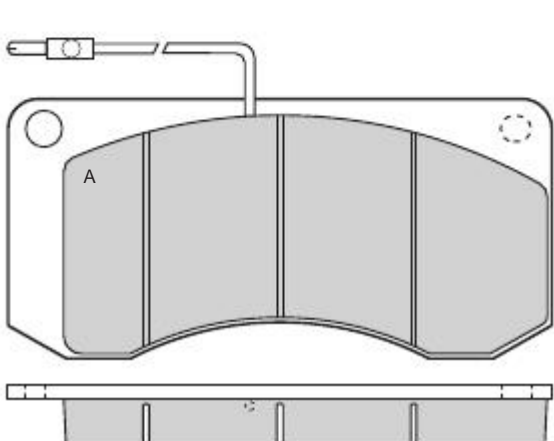

5240	IVECO	PERROT	X	179,6	106	20	3A-3B 1C-1D	2	180
-------------	--------------	---------------	----------	--------------	------------	-----------	------------------------	----------	------------



5241	RENAULT	GIRLING	X	180,1	86,1	20	2A-2B	4	300
-------------	----------------	----------------	----------	--------------	-------------	-----------	--------------	----------	------------

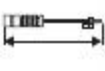

									
5242	RENAULT	BENDIX	X	166,7	61,6	17	2A 1B-1C	2	250

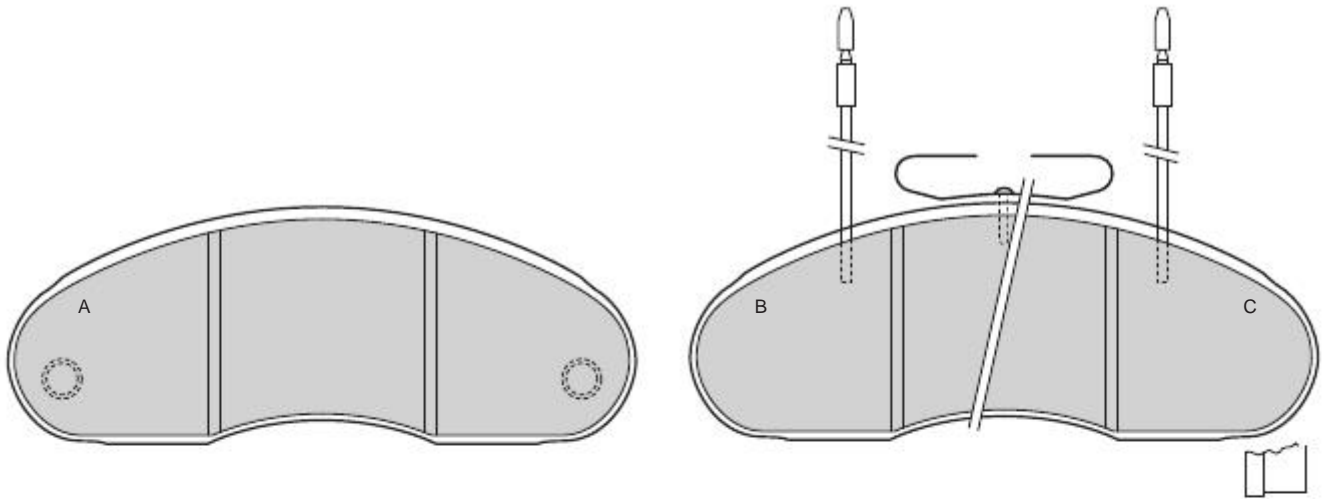



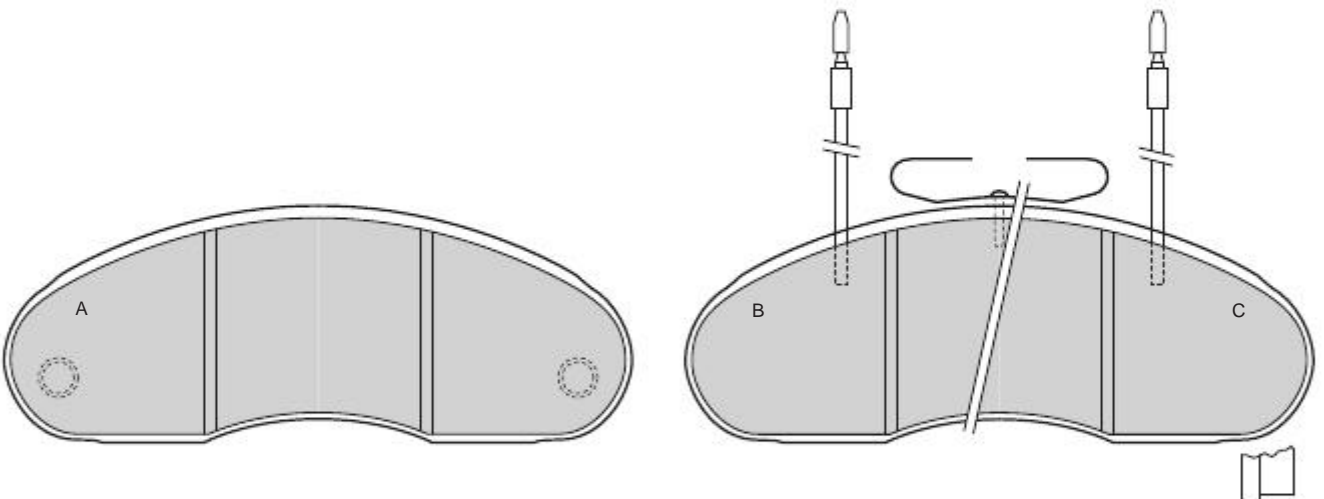



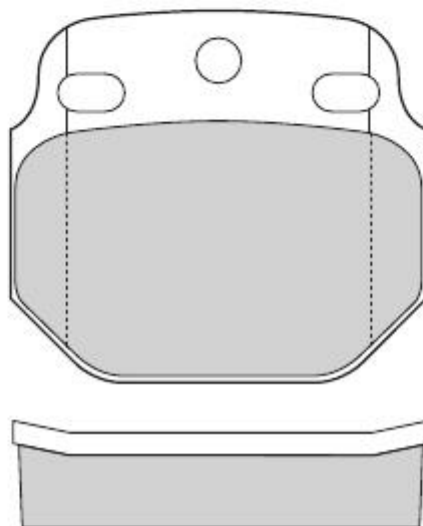



5243	RENAULT	BENDIX	X	166,7	61,6	14	2A 1B-1C	2	250
-------------	---------	--------	---	-------	------	----	-------------	---	-----



5244	IVECO	KNORR	X	110	98,5	25	8		
-------------	-------	-------	---	-----	------	----	---	--	--



									
5245	IVECO	BREMBO	X	61,8	57	15	4		

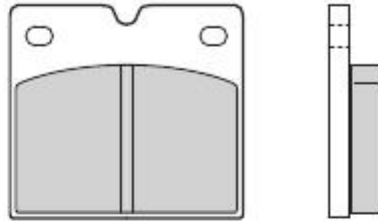



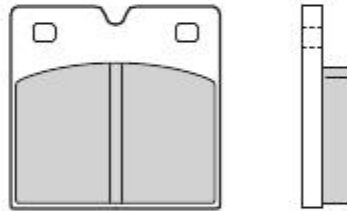



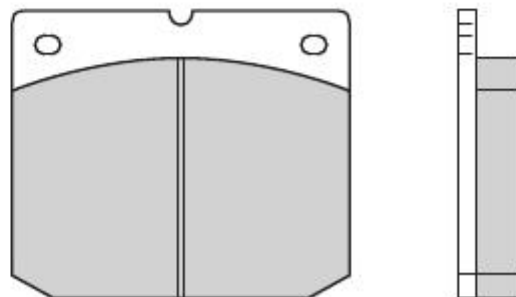



5246	IVECO	BREMBO	X	55,7	54	15	4		
-------------	-------	--------	---	------	----	----	---	--	--



5247	PALA ROSSI	BREMBO	X	90	76	17	4		
-------------	------------	--------	---	----	----	----	---	--	--



									
5248	DAF	KNORR	X	139,2	121	32	4		

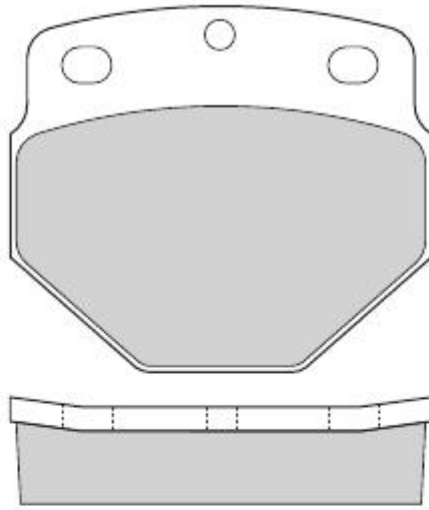



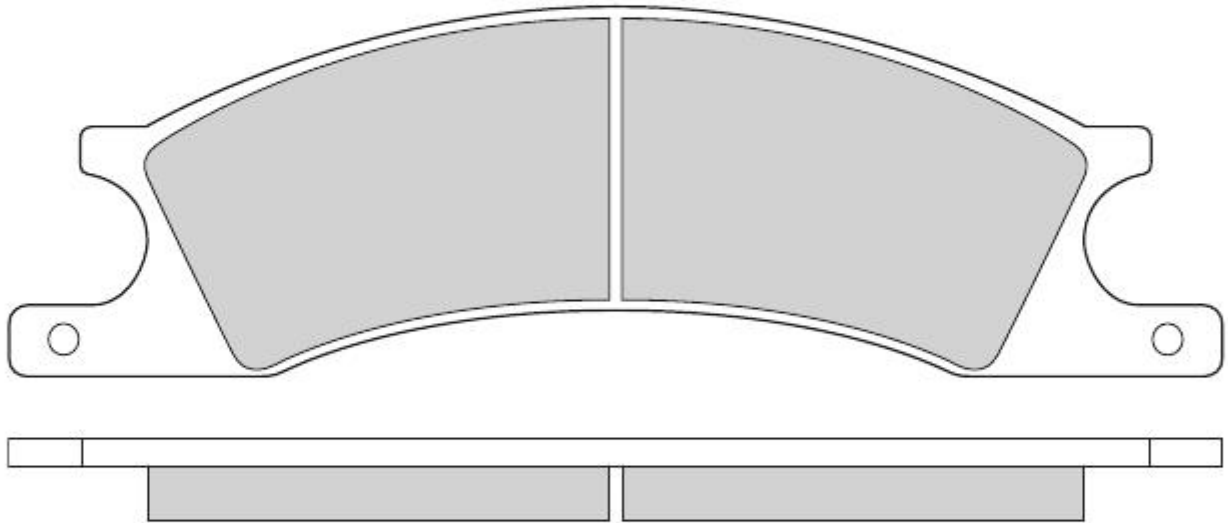



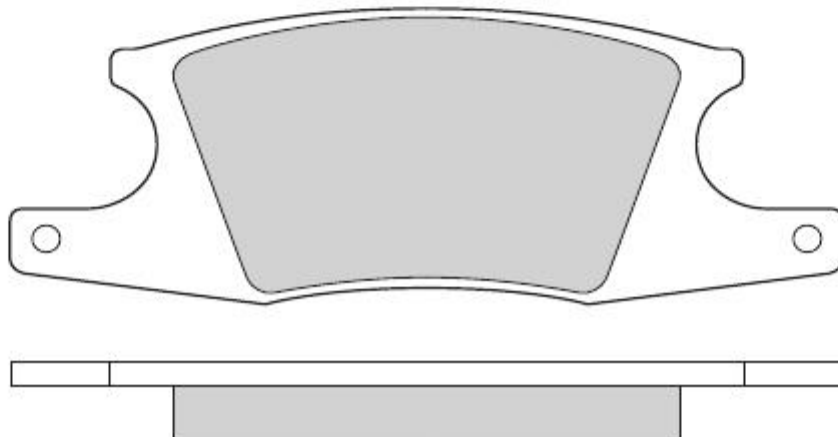

5249	FURUKAWA - KAWASAKI KOMATSU	SUMITOMO	X	320	97,9	22	4		
-------------	--------------------------------	----------	---	-----	------	----	---	--	--



5250	KAWASAKI	SUMITOMO	X	220	79	22	4		
-------------	----------	----------	---	-----	----	----	---	--	--

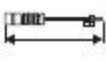

										
5251	IVECO	BENDIX	X	205,8	110	25	4	2	2	280 360

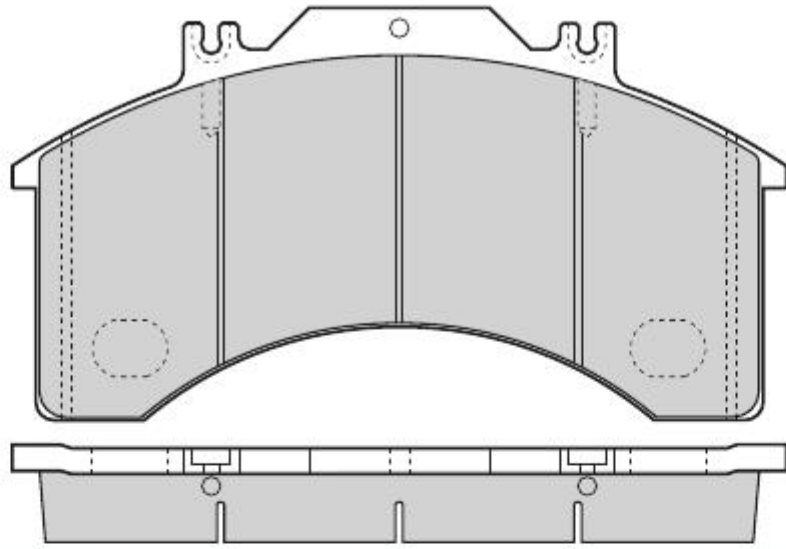
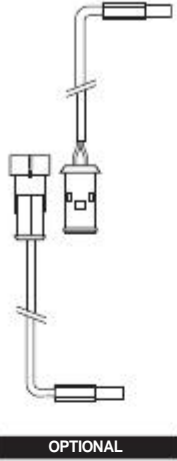



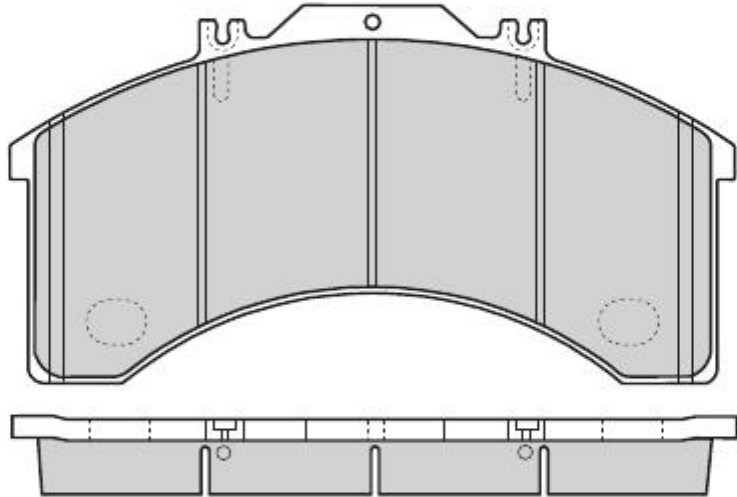
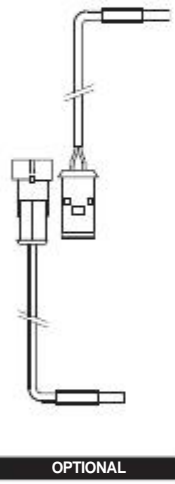



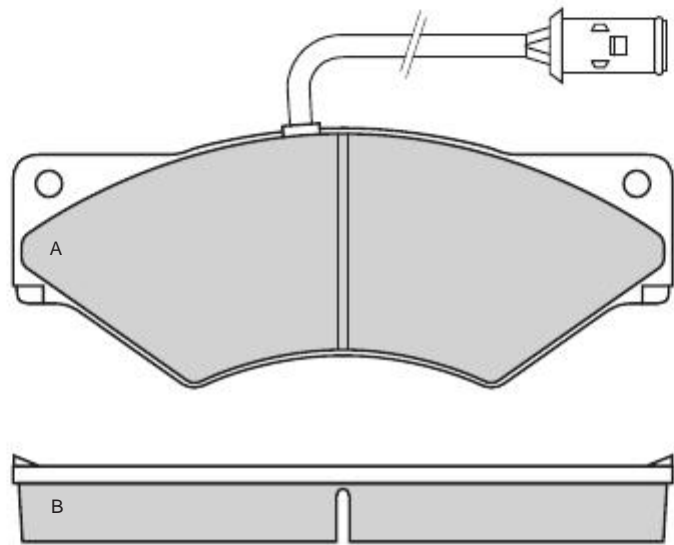



5252	IVECO	BENDIX	X	240,5	124,9	25	4	2	2	280 360
-------------	-------	--------	---	-------	-------	----	---	---	---	------------



5253	IVECO - FIAT OM	PERROT	X	174,4	69,3	20	2A-2B	2	2	225
-------------	-----------------	--------	---	-------	------	----	-------	---	---	-----



									
5254	MERCEDES	ATE	X	150	81,5	20,3	4	4	

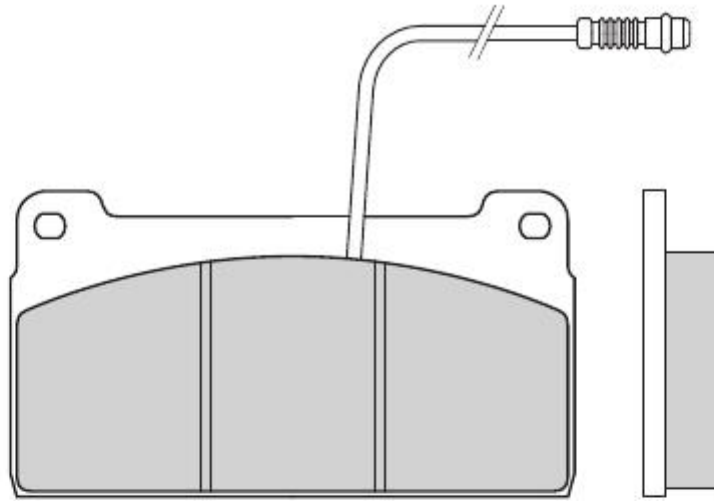



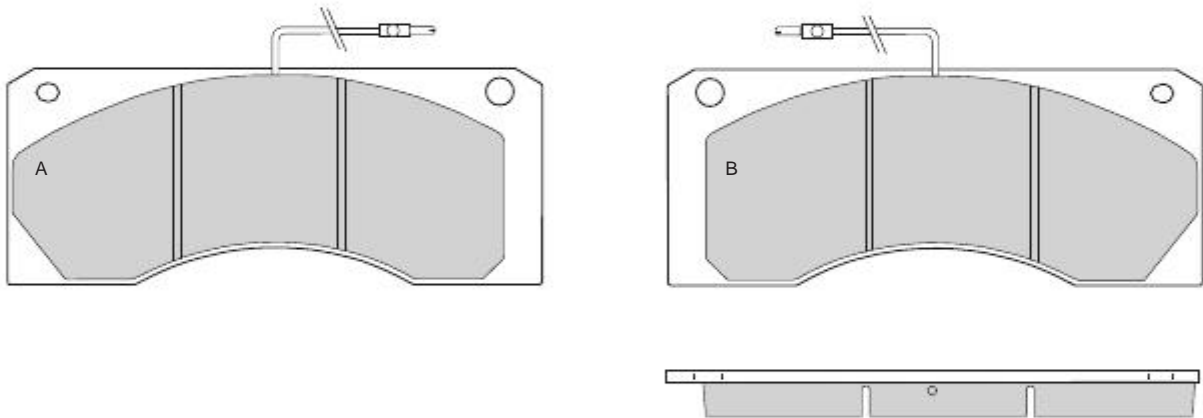





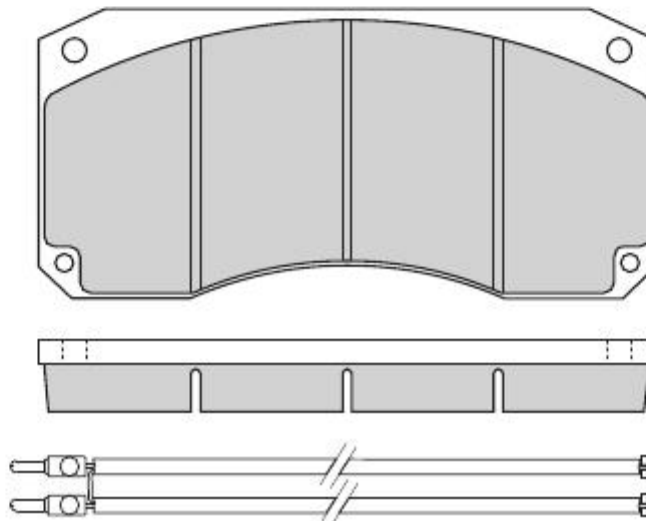

5255	RENAULT	GIRLING	X	235,8	95	20	2A-2B	4	350
------	---------	---------	---	-------	----	----	-------	---	-----



30%

5256	RENAULT	PERROT	X	203,9	95,7	24	4	4	420
------	---------	--------	---	-------	------	----	---	---	-----



									
5257	INBUS	PERROT	X	162,2	111,3	27,5	2A-6B		

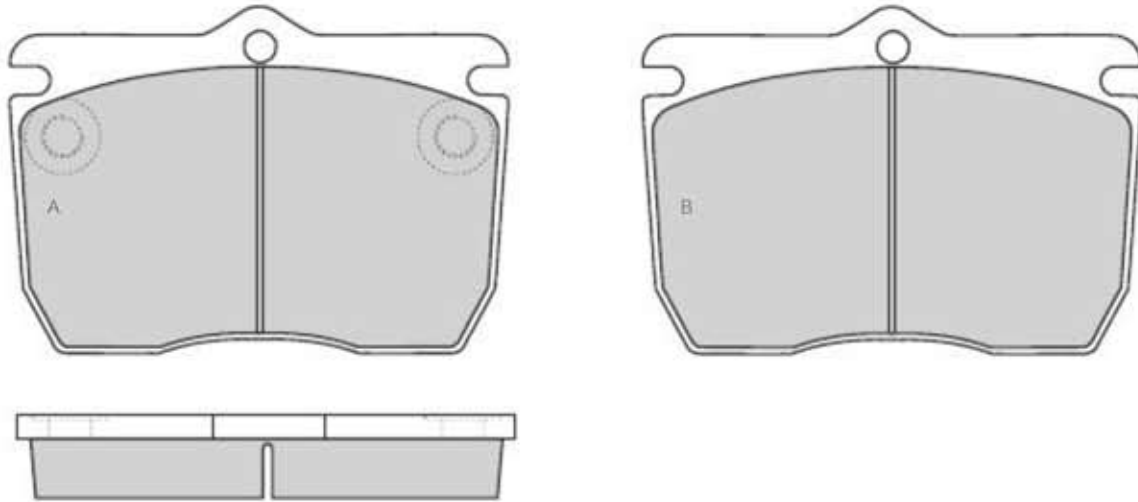



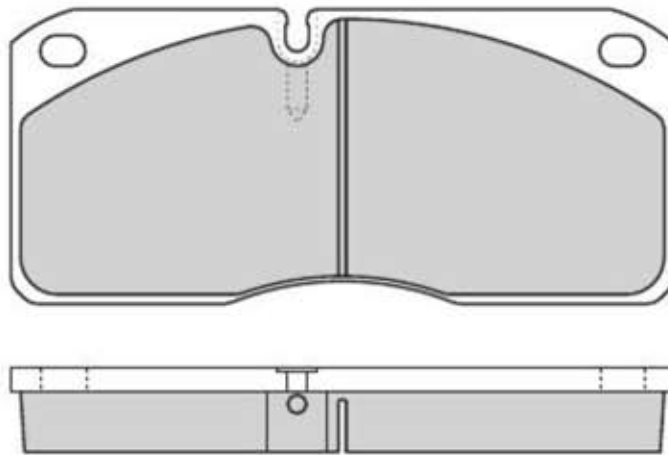



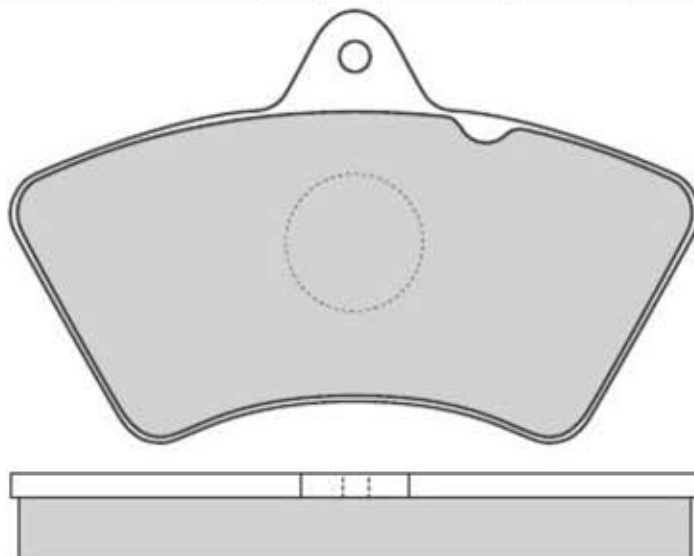



5258	FIAT	GIRLING	X	175,4	78	22	4		
------	------	---------	---	-------	----	----	---	--	--



5259	KÄSSBOHRER	KNORR	X	179,1	113	22	8		
------	------------	-------	---	-------	-----	----	---	--	--



									
5260	KÄSSBOHRER	KNORR	X	179	113	20	8		

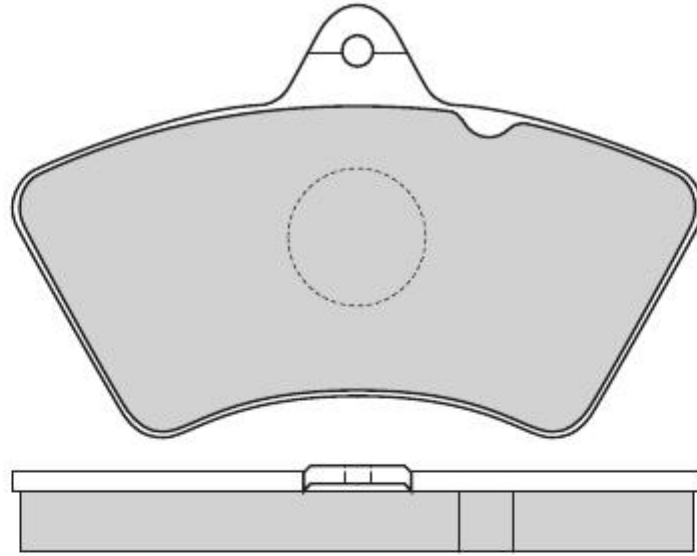



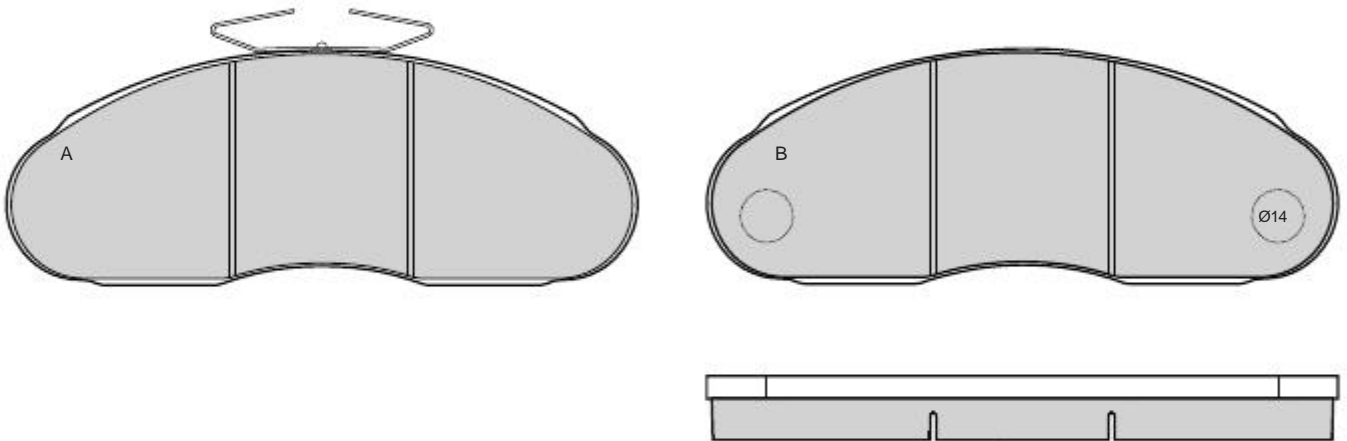



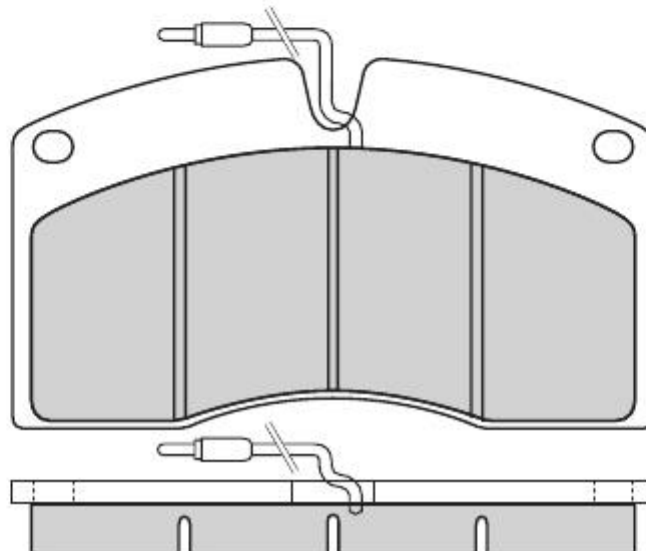



5261	RENAULT	BENDIX	X	166,75	62	17	2A-2B		
-------------	---------	--------	---	--------	----	----	-------	--	--



5262	RENAULT RVI	BREMBO	X	169,5	98	19,2	8	8	350
-------------	-------------	--------	---	-------	----	------	---	---	-----



									
5263	KASSBOHRER - SETRA	ATE	X	385	140.5	29	4		

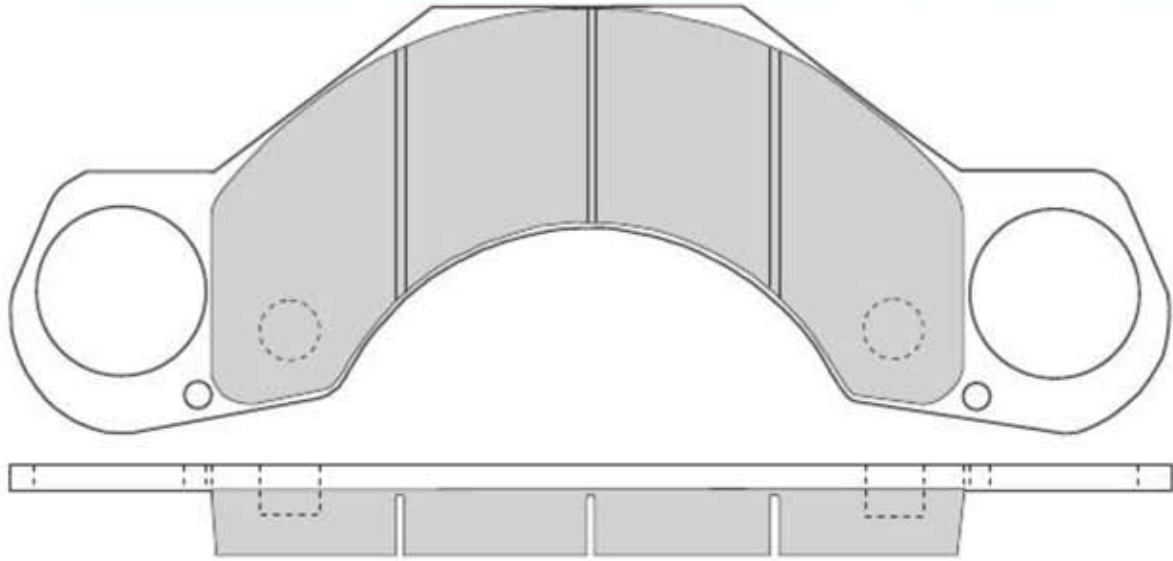





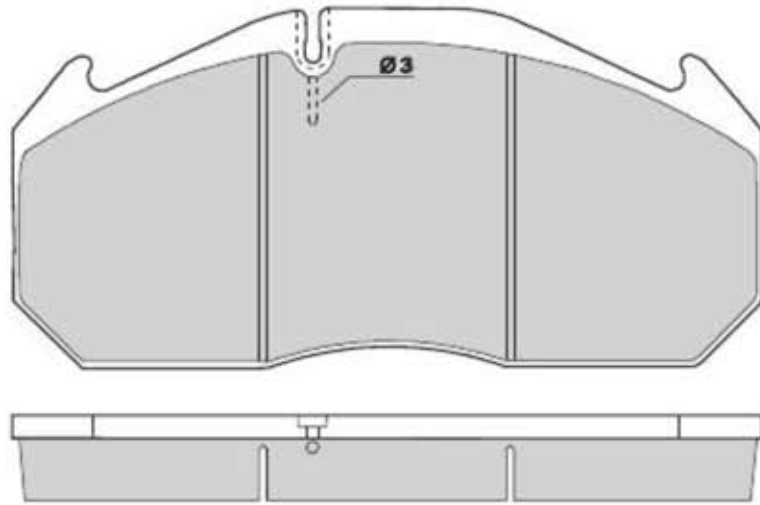
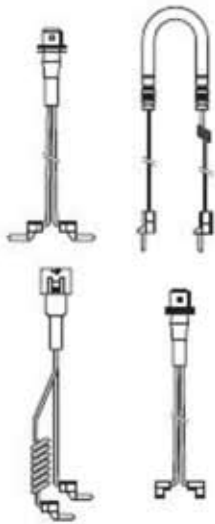



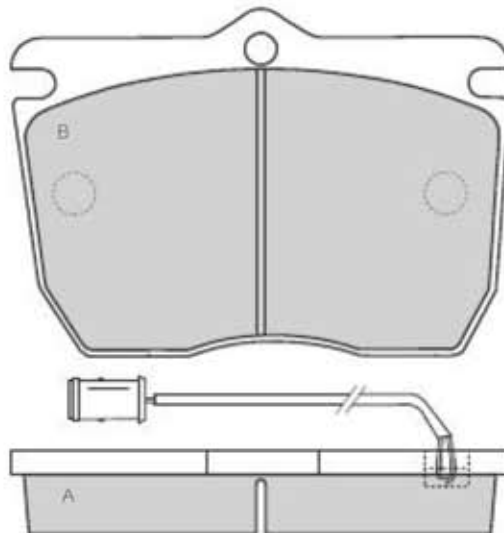

5264	FIAT - KASSBOHRER MERCEDES - RENAULT	LUCAS	X	249.5	118.3	28.2	4		
------	---	-------	---	-------	-------	------	---	--	--

OPTIONAL



5265	HANOMAG - INBUS KASSBOHRER	PERROT	X	162.2	111.3	27.5	2A-6B	2	410
------	-------------------------------	--------	---	-------	-------	------	-------	---	-----

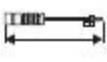

									
5266	IVECO	PERROT	X	191,1	87,1	22,6	2A-2B	2	410

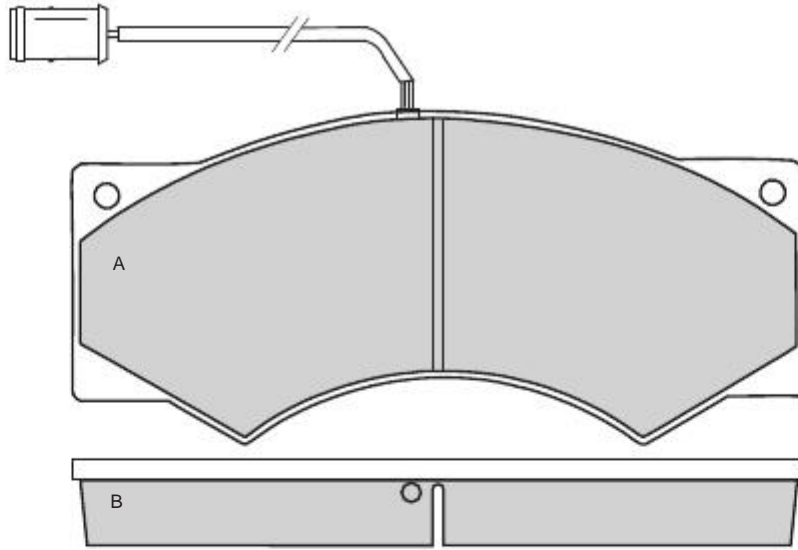



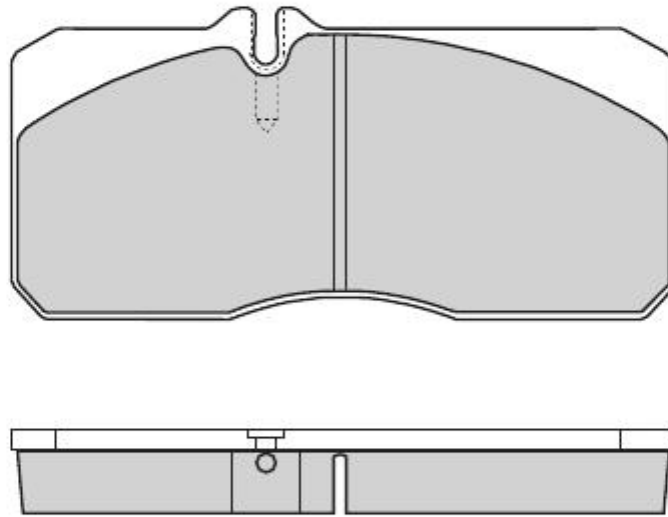



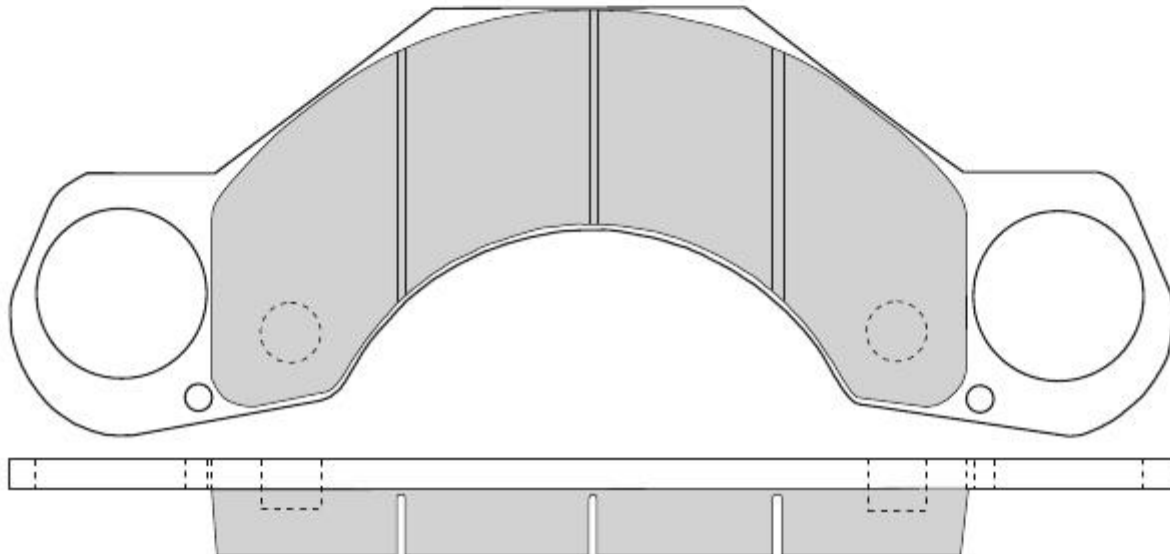



5267	MAN	GIRLING	X	175,8	82,5	22	4		
-------------	-----	---------	---	-------	------	----	---	--	--



5268	KÄSSBOHRER - SETRA	ATE	X	X	385	140,5	31	4	
-------------	--------------------	-----	---	---	-----	-------	----	---	--



									
5269	MENARINI	BREMBO	X	117,5	107	21,5	2A-2B	2	210

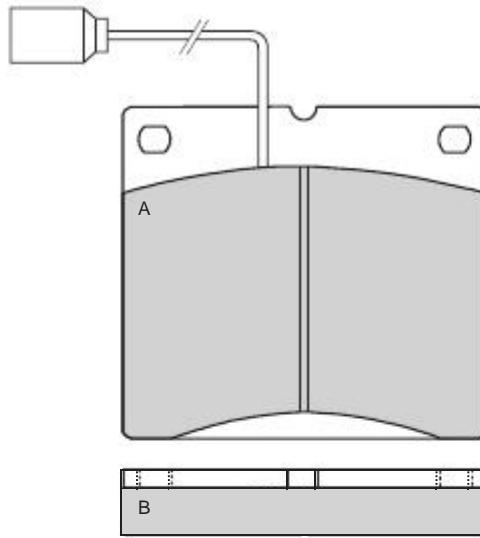



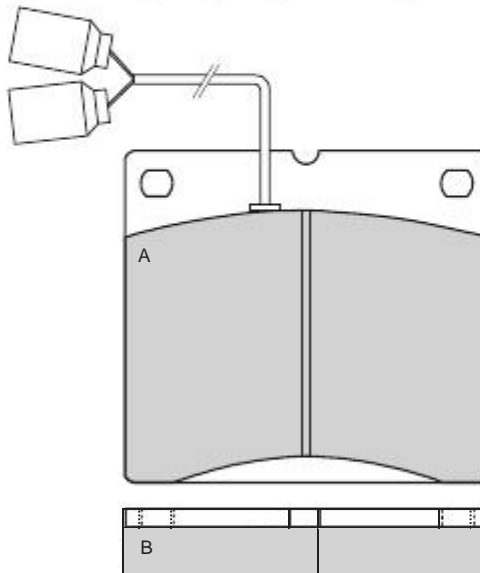



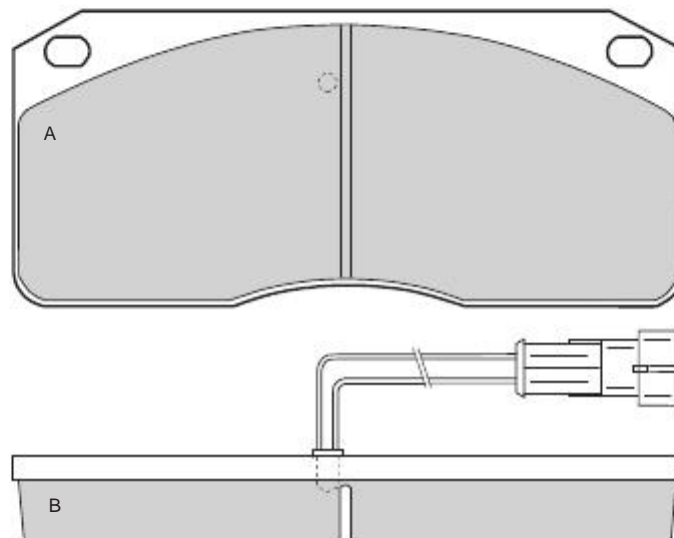

5270	MENARINI	BREMBO	X	117,5	107	21,5	2A-2B	2	200
-------------	----------	--------	---	-------	-----	------	-------	---	-----



5271	IVECO	GIRLING	X	175,3	78,5	22	2A-2B	2	280
-------------	-------	---------	---	-------	------	----	-------	---	-----

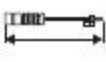

									
5272	IVECO	LUCAS	X	174,9	85,5	21,7	2A-2B	2	500

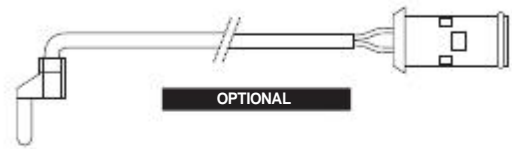
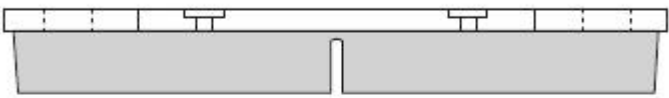
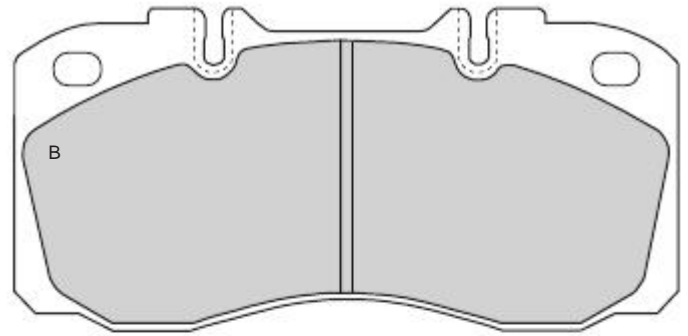
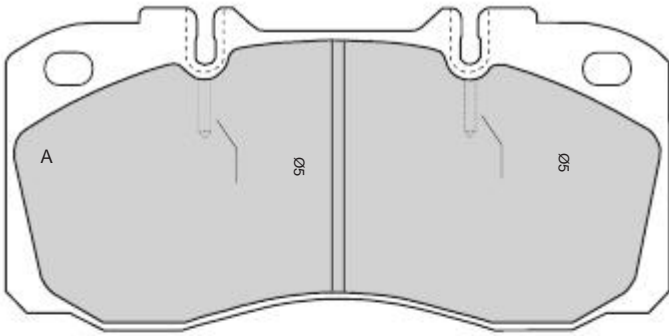



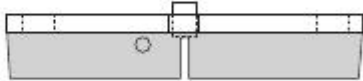
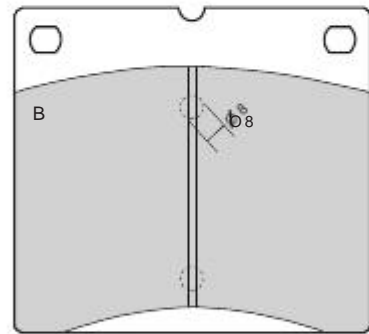
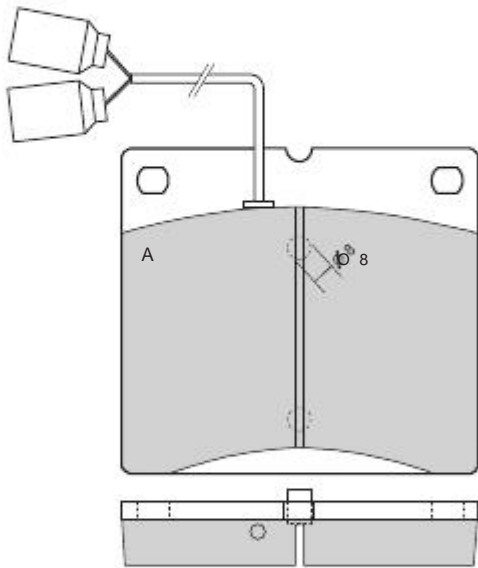



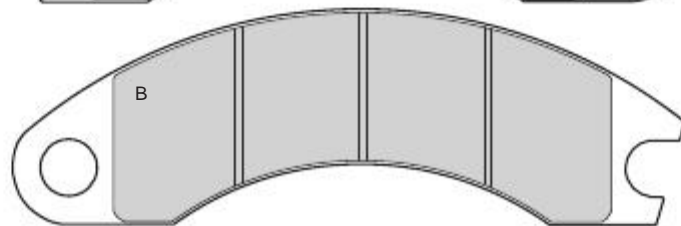
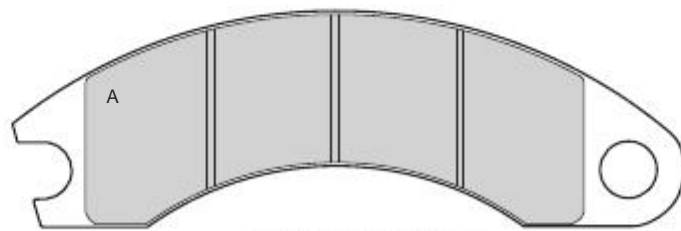

5273	MENARINI	BREMBO	X	117,5	107	21,5	2 A-6B	2	200
------	----------	--------	---	-------	-----	------	--------	---	-----



5274	ASTRA	CRL	X	X	444	143	25	1A-1B	
------	-------	-----	---	---	-----	-----	----	-------	--

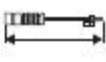

20%

									
5275		BREMBO		76,5	72	16	4		

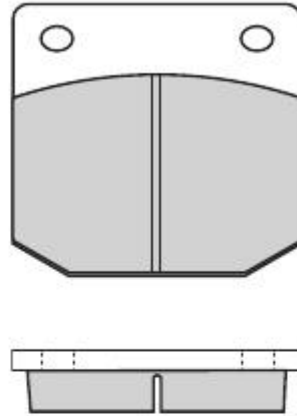



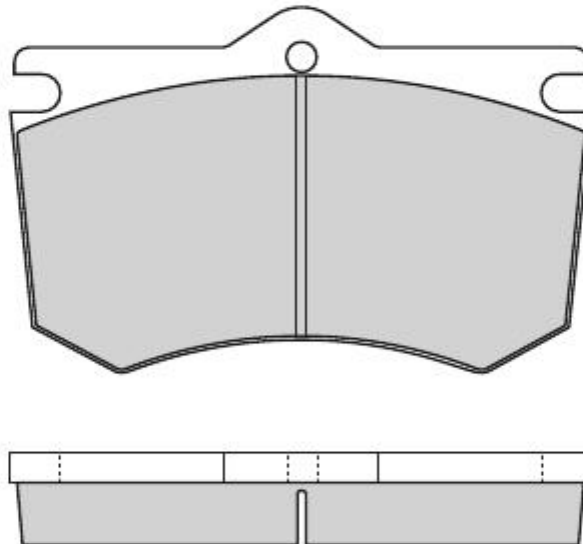



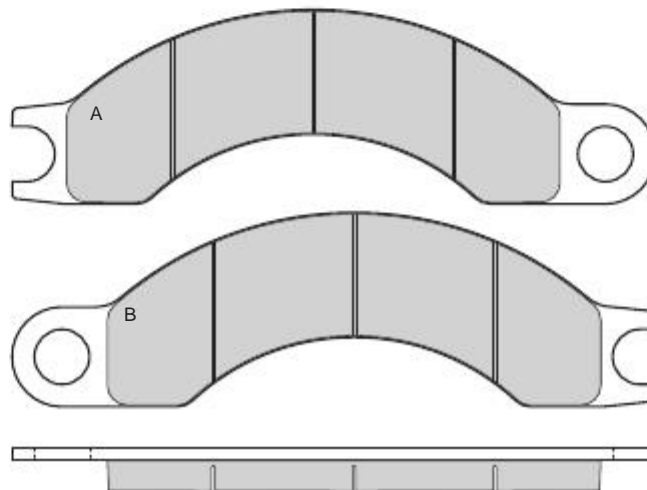



5276	VEICOLO SPECIALE	PERROT	X	153,9	96,5	25	4		
-------------	------------------	--------	---	-------	------	----	---	--	--



5277	CATERPILLAR O & K - VALMET	CRL	X	425	128,5	28	1A-1B		
-------------	-------------------------------	-----	---	-----	-------	----	-------	--	--



20%

									
5278	MERCEDES - SCANIA	KNORR	X	X	247,6	109,5	30	4	

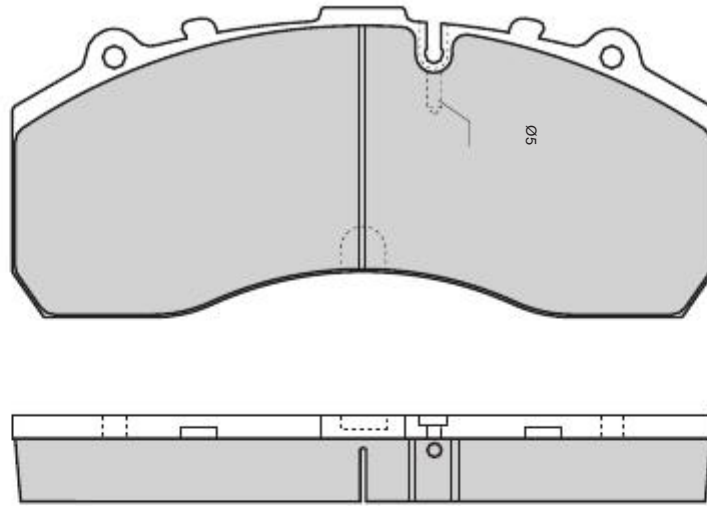

5279	RIMORCHIO	BREMBO	X	X	137,2	115	25	4	
-------------	-----------	--------	---	---	-------	-----	----	---	--

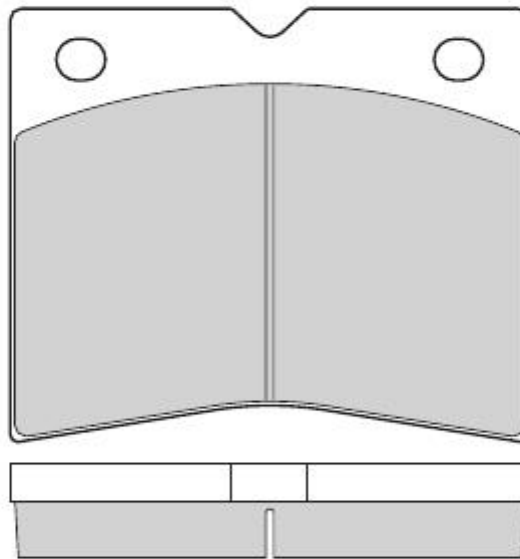

5280	RENAULT - VOLVO	LUCAS	X		249	114,4	28	4	4	360
-------------	-----------------	-------	---	--	-----	-------	----	---	---	-----

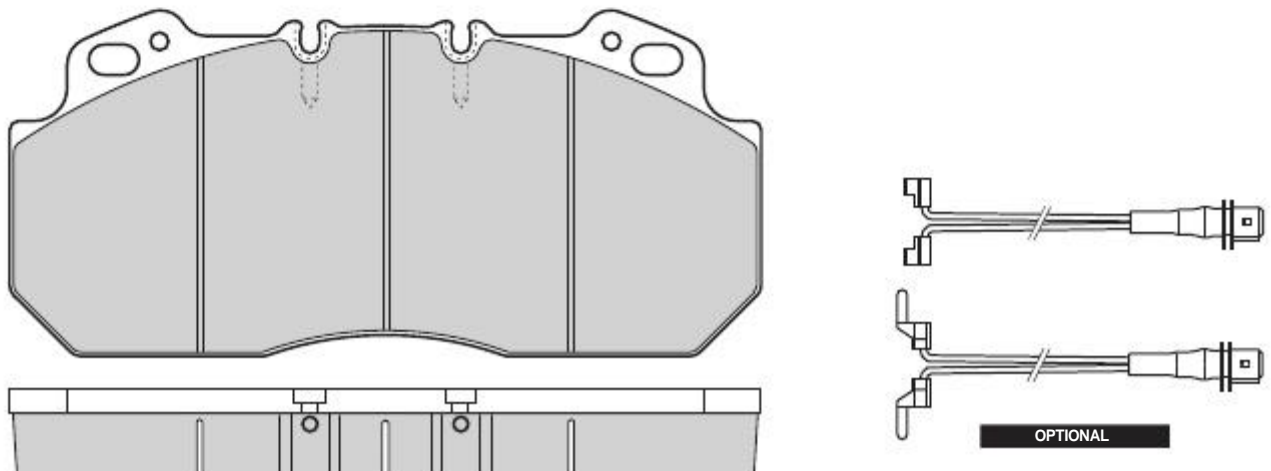



5281	DAF	PERROT	X		204,5	106	27	4		

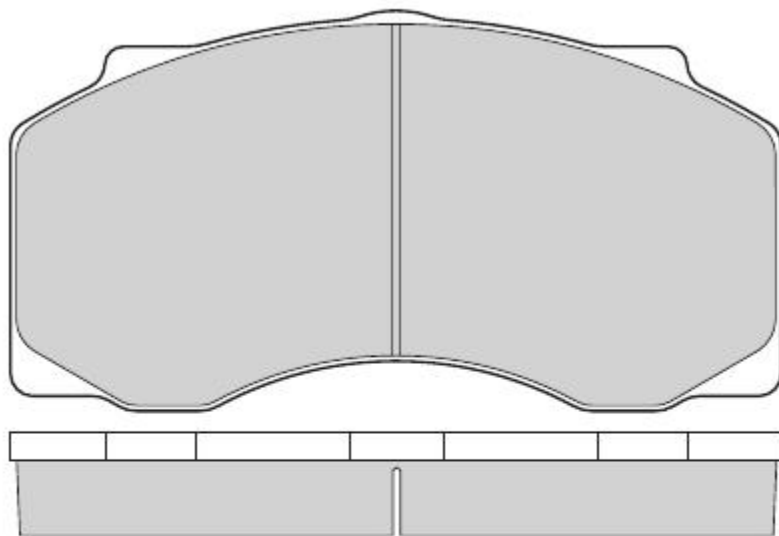



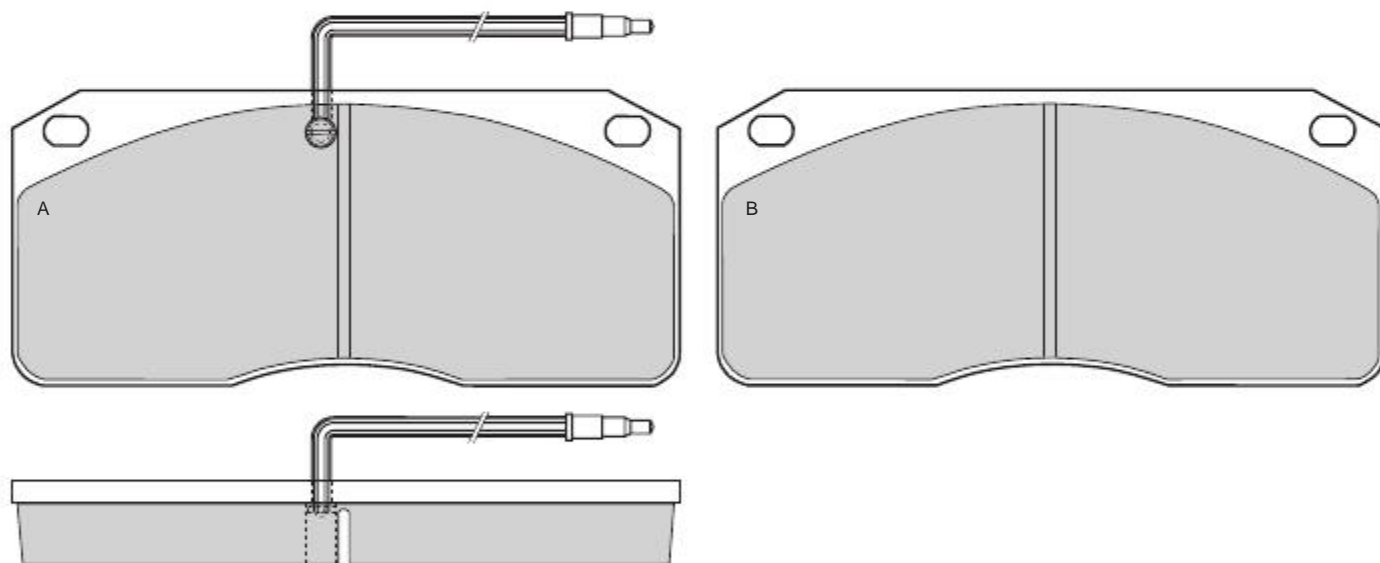



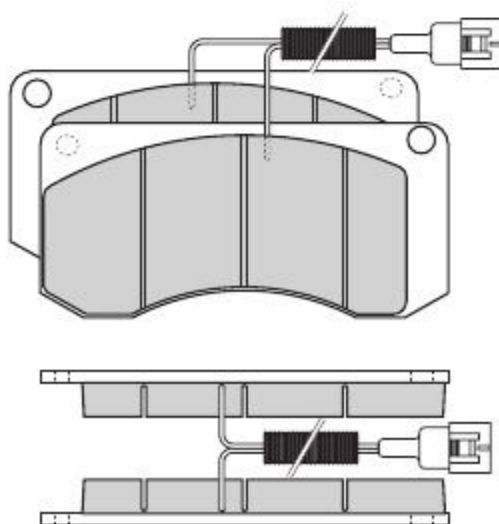



5282	VOLVO	GIRLING	X	X	175,3	78,5	22	2A-2B	2	230
-------------	-------	---------	---	---	-------	------	----	-------	---	-----



5283	RENAULT	GIRLING	X		180	86,5	20,5	4	2	955
-------------	---------	---------	---	--	-----	------	------	---	---	-----



Reference in this Catalogue to other manufacturers and to part numbers and other descriptions are for identification purposes only, because the above **DISC BRAKE PADS** are **NOT ORIGINAL** but with these interchangeable

									
5284	MAN	KNORR	X	210,5	92,4	32	4		

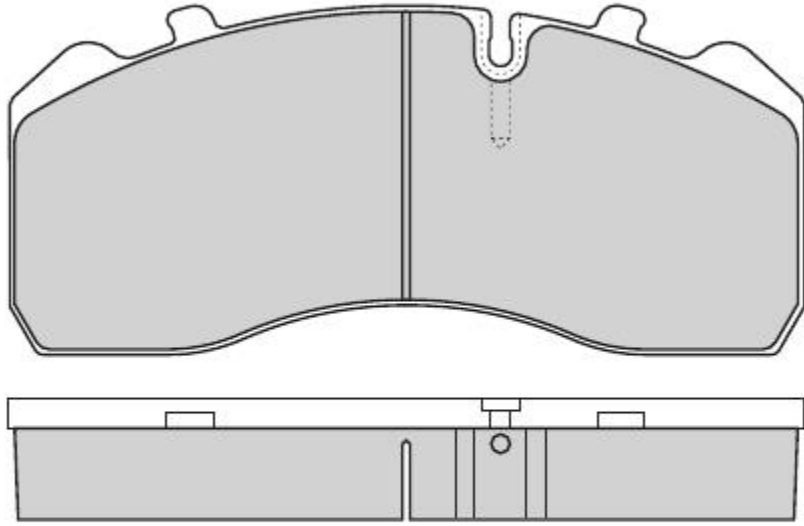



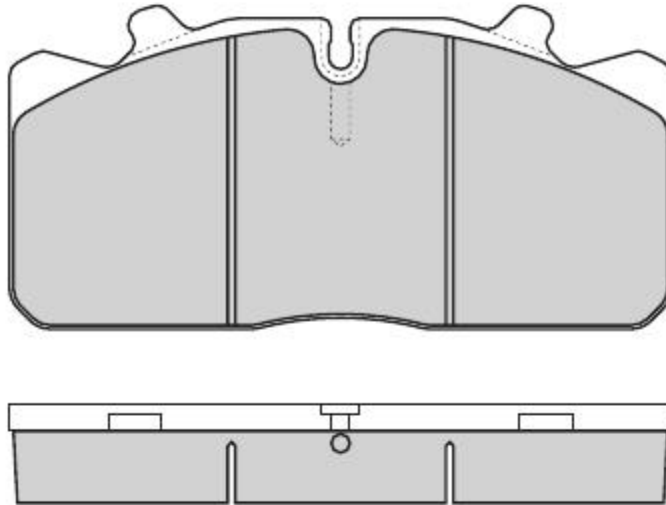



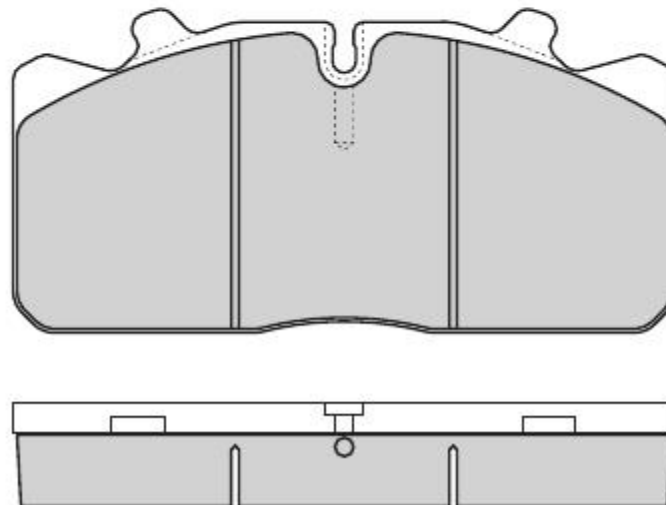

5285	MAN	PERROT	X	175,4	86,25	26	4		
-------------	-----	--------	---	-------	-------	----	---	--	--



5286	MAN	PERROT	X	175,4	82,5	27	4		
-------------	-----	--------	---	-------	------	----	---	--	--

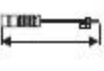

									
5287	PERROT	PERROT	X	137,7	82	11	4		

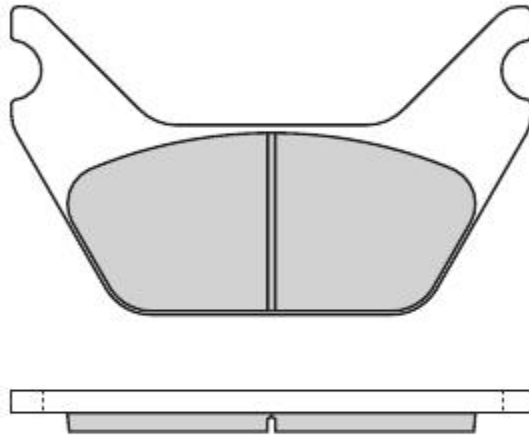



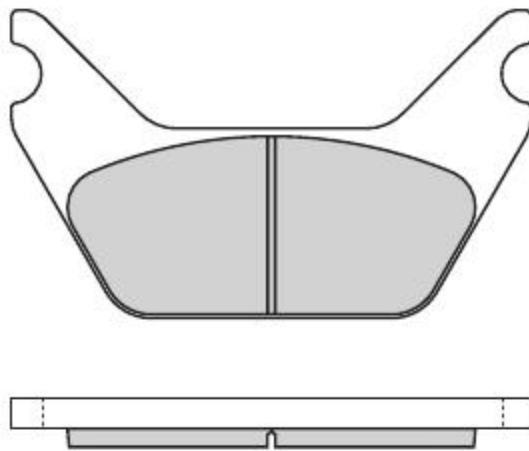



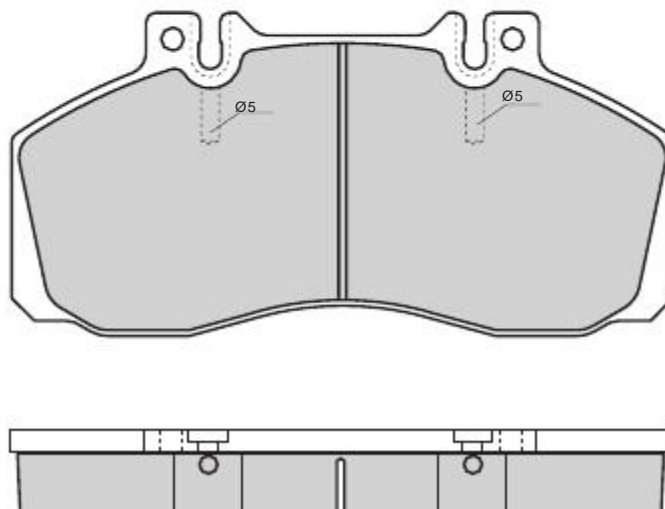

5288	PERROT	PERROT	X	137,7	82	14	4		
-------------	--------	--------	---	-------	----	----	---	--	--



5289	IVECO - RENAULT	GIRLING	X	175,1	85,6	21,7	4		
-------------	-----------------	---------	---	-------	------	------	---	--	--

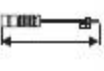

									
5290	RENAULT	LUCAS		249,5	118,3	28,2	4		

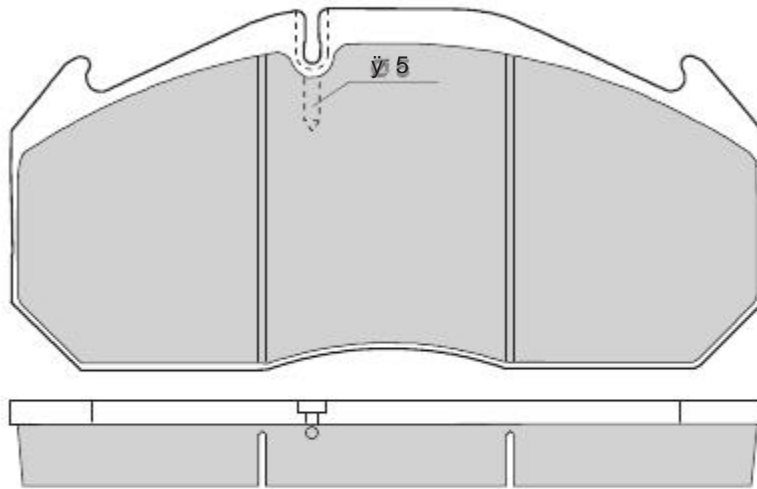



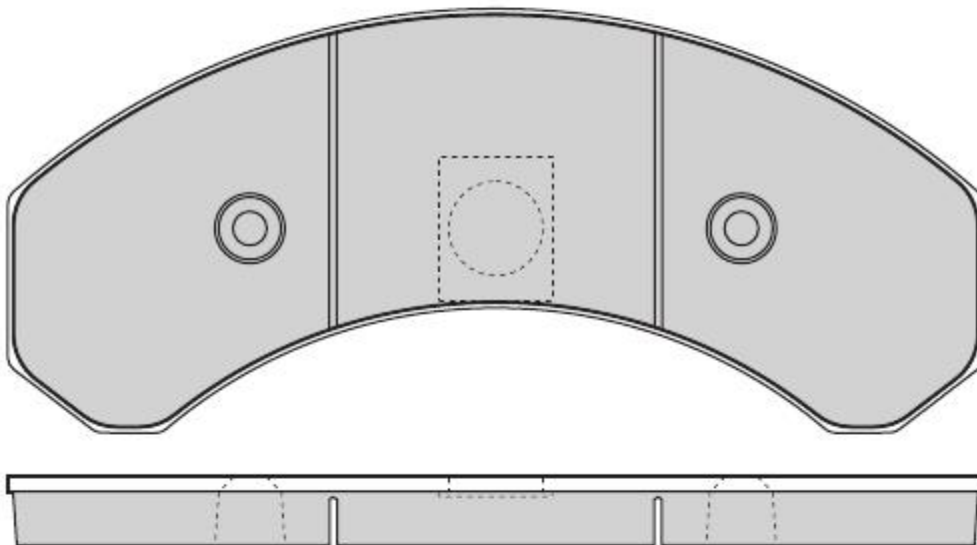



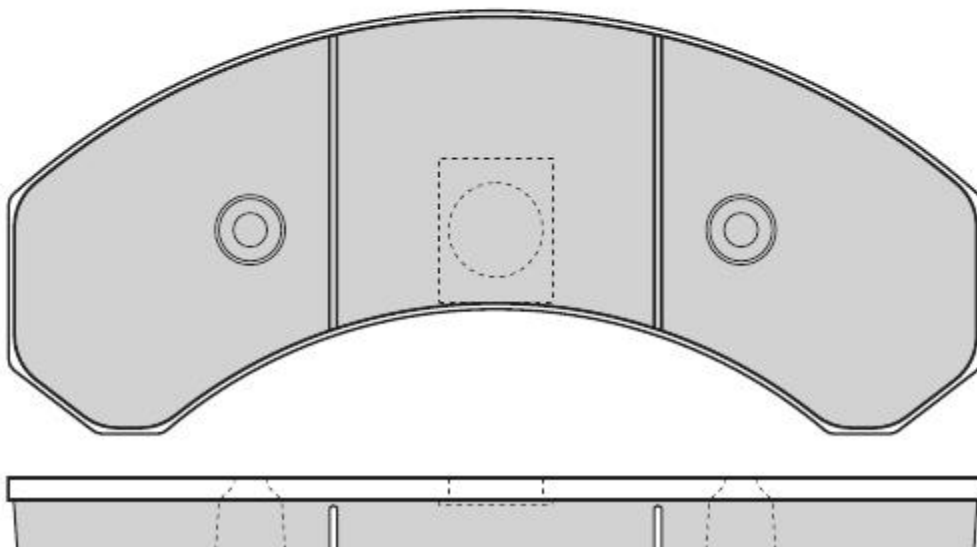

5291	KASSBOHRER	KNORR	X	258	112,1	18	4		
-------------	------------	-------	---	-----	-------	----	---	--	--



5292	KASSBOHRER	KNORR	X	258	112,1	20	4		
-------------	------------	-------	---	-----	-------	----	---	--	--

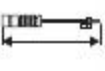

									
5293	MAN - MERCEDES SAF SAUER	KNORR		210,5	92,4	30	4		

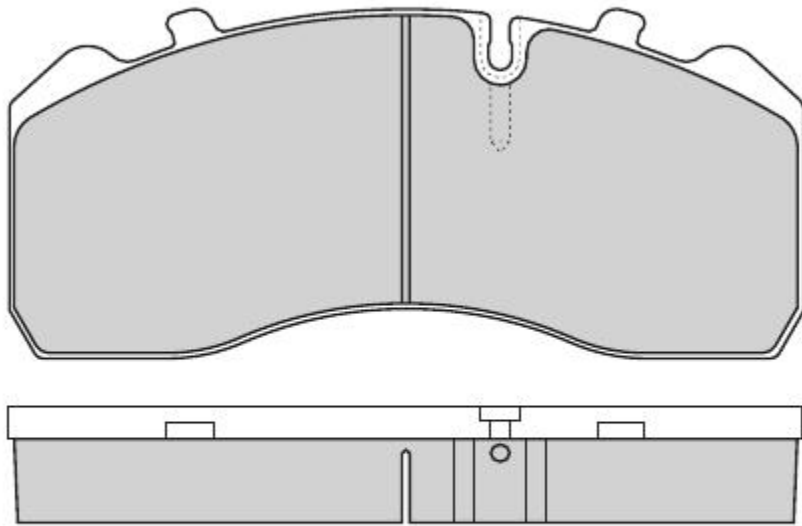



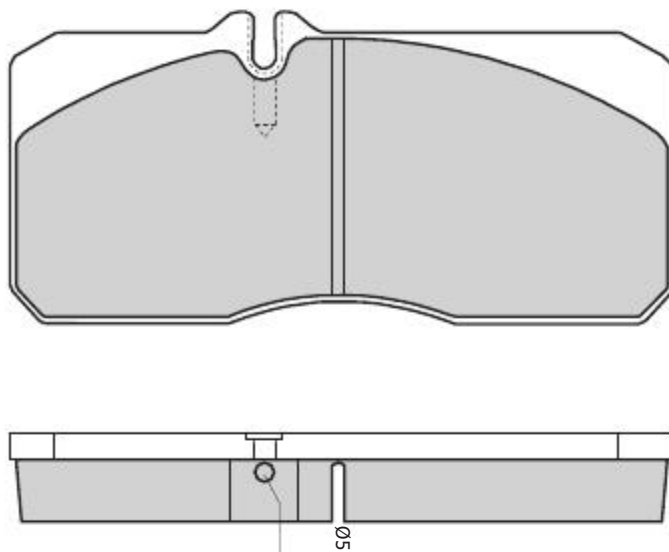



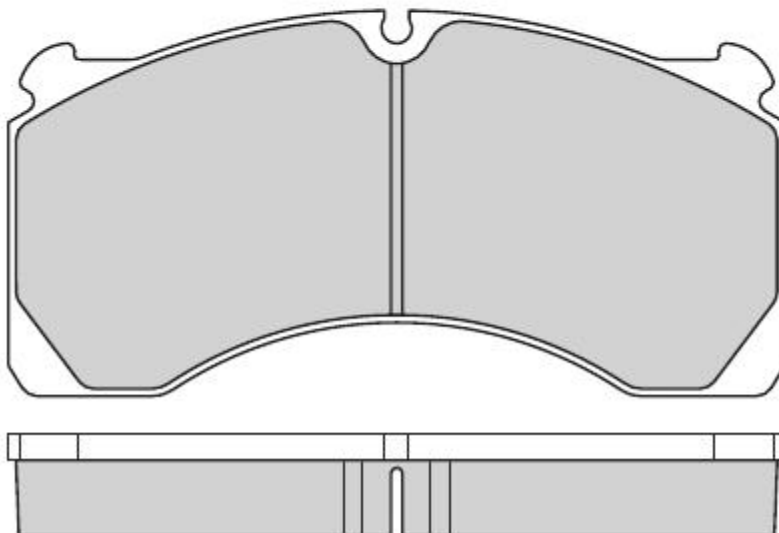



5294	MAN	PERROT	X	175,8	82,5	23	4		
-------------	-----	--------	---	-------	------	----	---	--	--



5295	R.O.R.	MERITOR	X	205,5	102	27	4		
-------------	--------	---------	---	-------	-----	----	---	--	--



									
5296	HANOMAG	PERROT		151,2	114,4	26	4	4	280

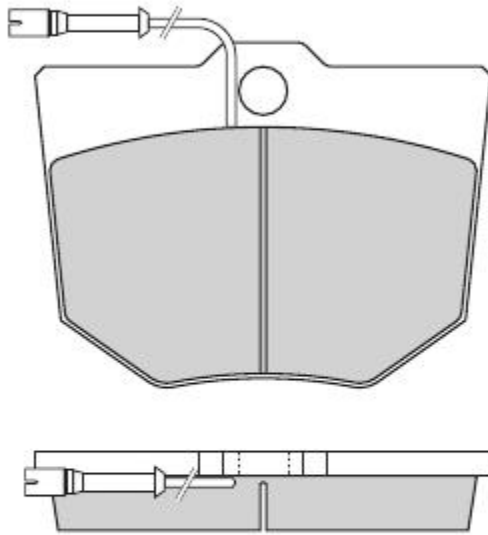



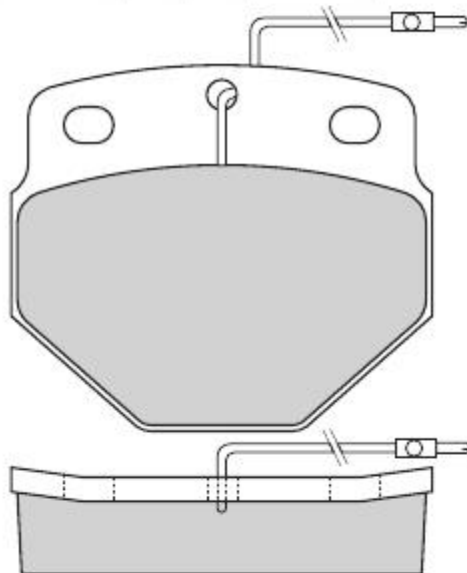



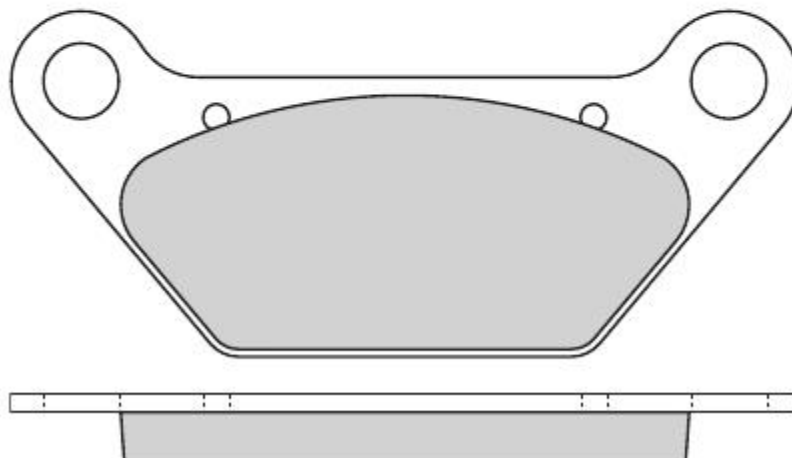



5297	DAF	KNORR	X	139,2	121	32	4	4	520
-------------	-----	-------	---	-------	-----	----	---	---	-----



5298			X	208,6	91,5	17,7	4		
-------------	--	--	---	-------	------	------	---	--	--



									
5299	NISSAN - RENAULT	GIR		213,8	111,75	25	4		

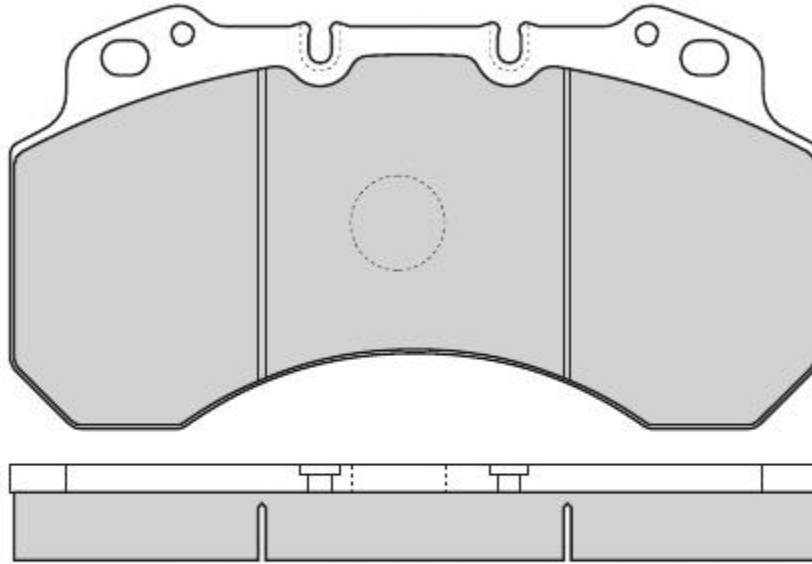



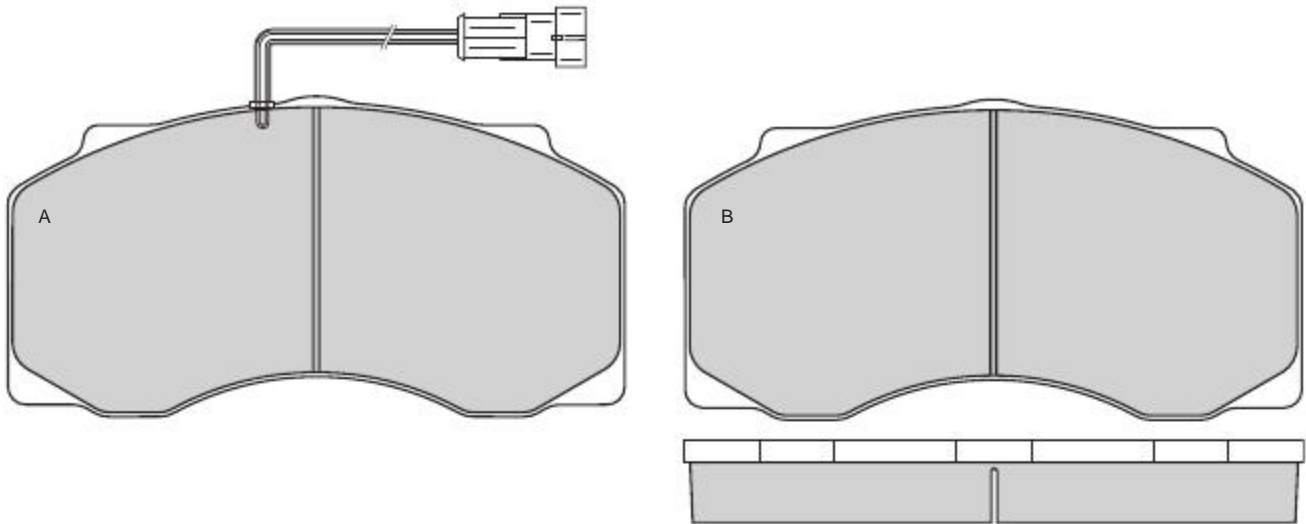



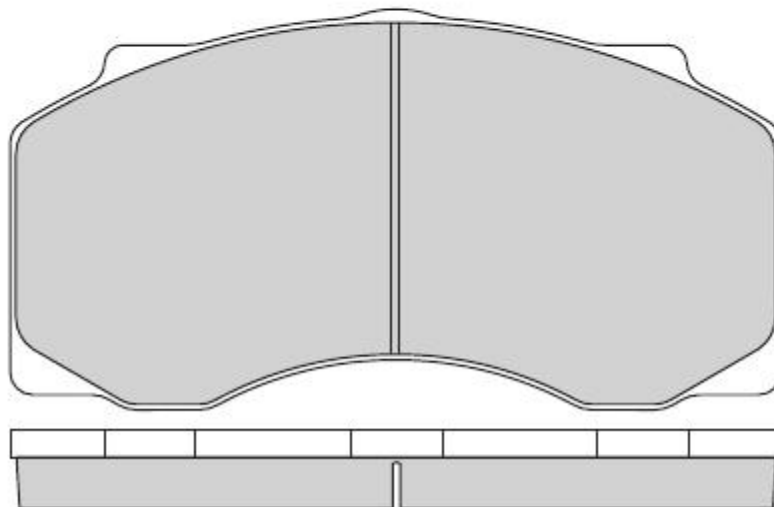

5300	ASTRA	PERROT	X	204,5	106	27	2A-2B	2	380
-------------	-------	--------	---	-------	-----	----	-------	---	-----



5301	ASTRA	PERROT	X	204,5	106	20,7	4		
-------------	-------	--------	---	-------	-----	------	---	--	--

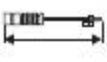

									
5302	MENARINI	BREMBO		170	99	19	4A-4B	4	460

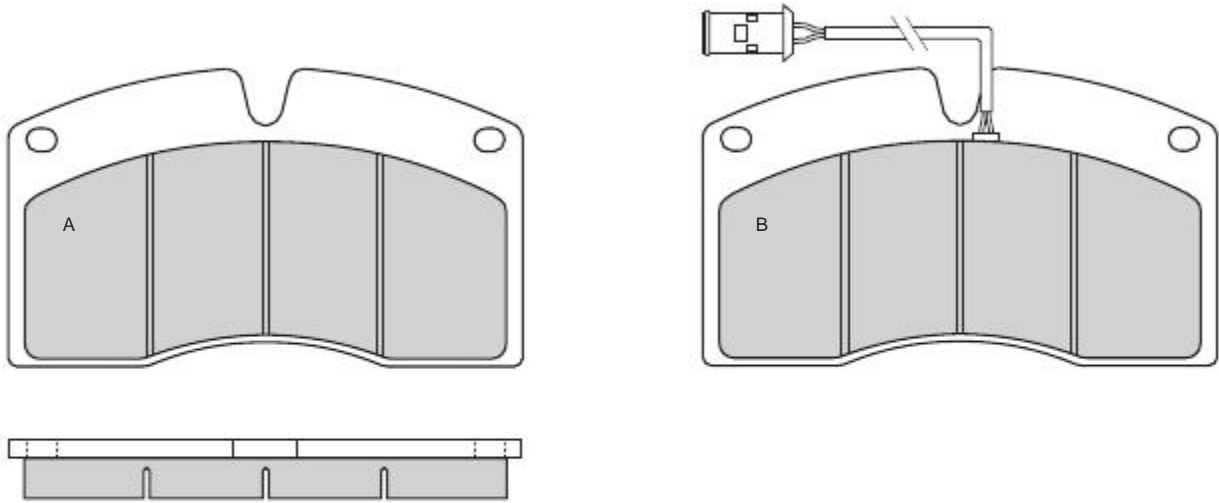



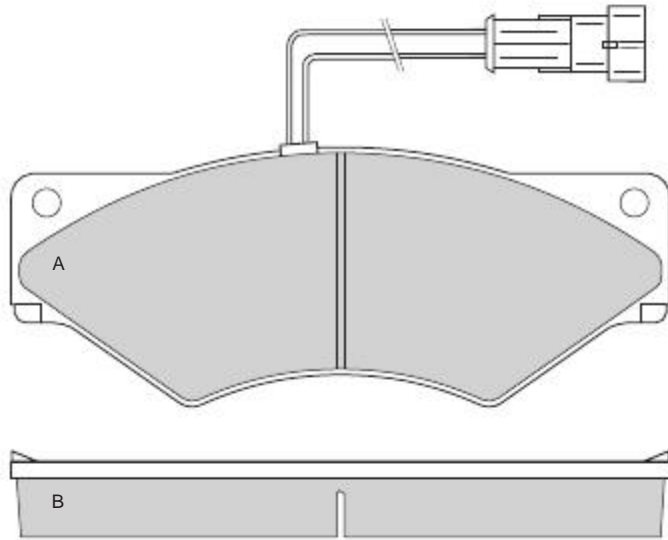



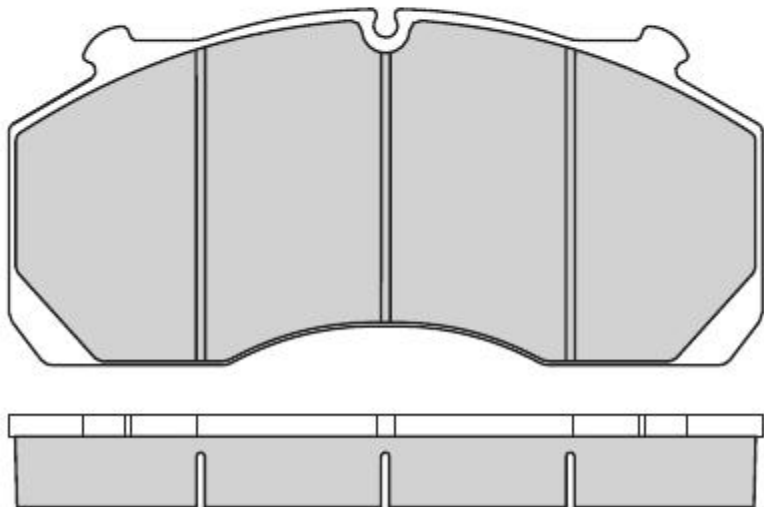

5303	IVECO	PERROT	X	174,4	69,3	20	2A-2B	2	285
-------------	-------	--------	---	-------	------	----	-------	---	-----



5304	MERITOR	MERITOR	X	248,9	117,65	30	4		
-------------	---------	---------	---	-------	--------	----	---	--	--

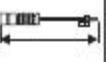

									
5305	MERITOR	MERITOR		179,5	92	28			180

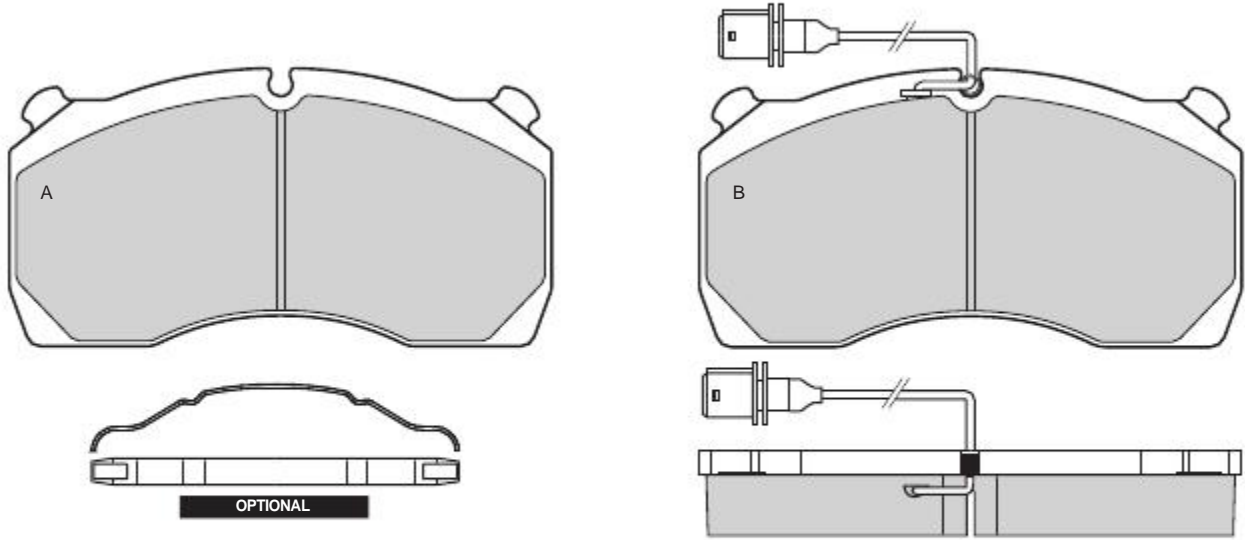



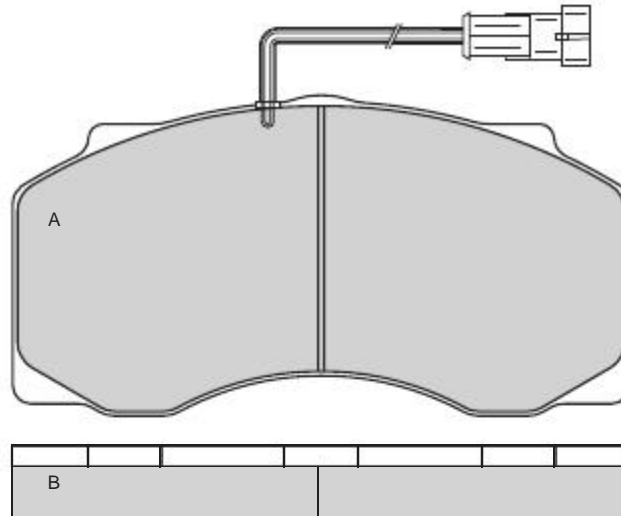



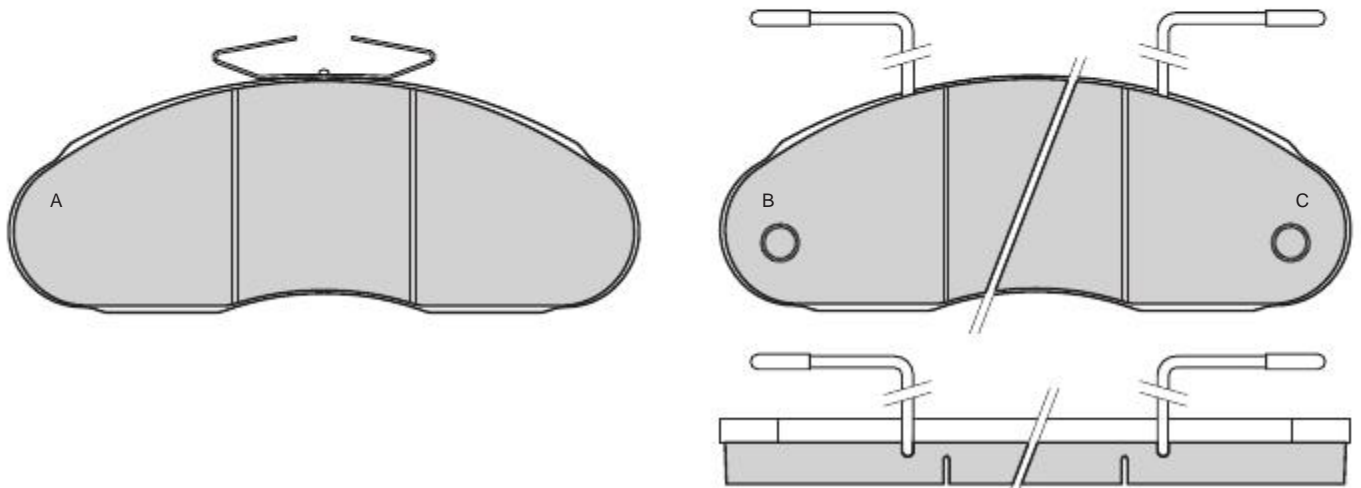



5306	ASTRA	PERROT	X	204,5	106	20,7	2A-2B	2	380
------	-------	--------	---	-------	-----	------	-------	---	-----



5307	NISSAN	BENDIX	X	166,75	62	17	2A 1B-1C	2	250
------	--------	--------	---	--------	----	----	-------------	---	-----



										
5308	RIMORCHIO (TRAILER) - SCANIA SAF - DISCOS - SMB	HALDEX	X		247,4	105	30	4	2	285

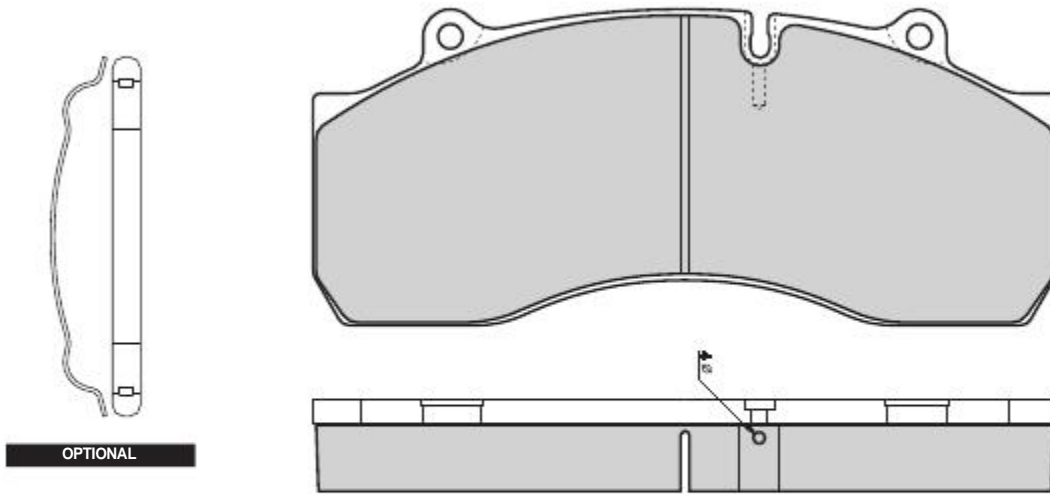



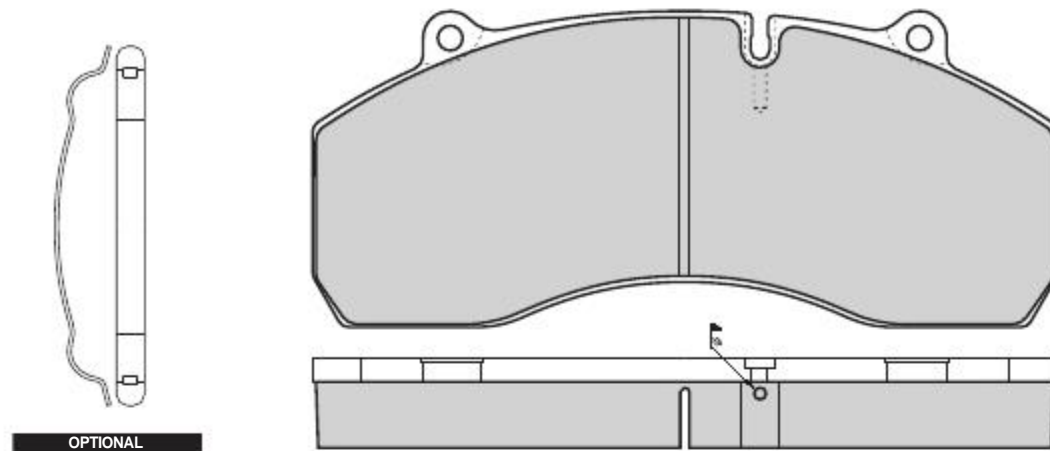



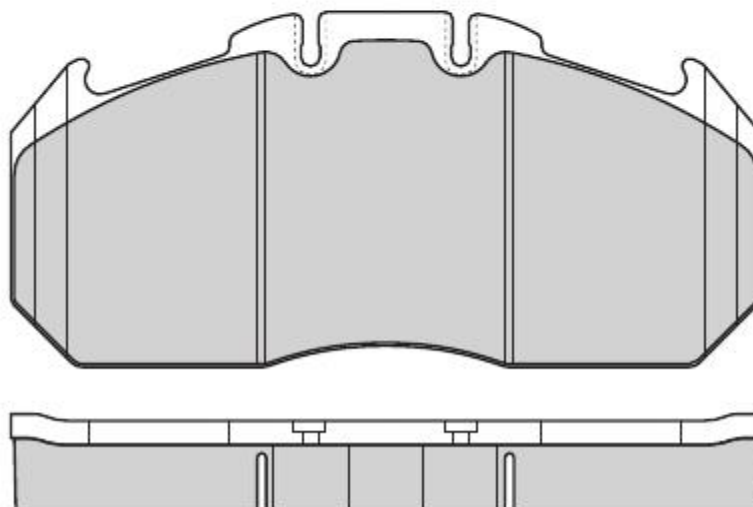

5309	RIMORCHIO (TRAILER) - SCANIA SAF - SAER - DISCOS - SMB	HALDEX	X	X	247,4	105	30	4	2	285
-------------	---	--------	---	---	-------	-----	----	---	---	-----



5310	MAN - RENAULT	MERITOR	X	X	249,3	117,9	29,8	4		
-------------	---------------	---------	---	---	-------	-------	------	---	--	--

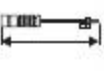

									
5311	PERLINI			174,6	151	34	4		

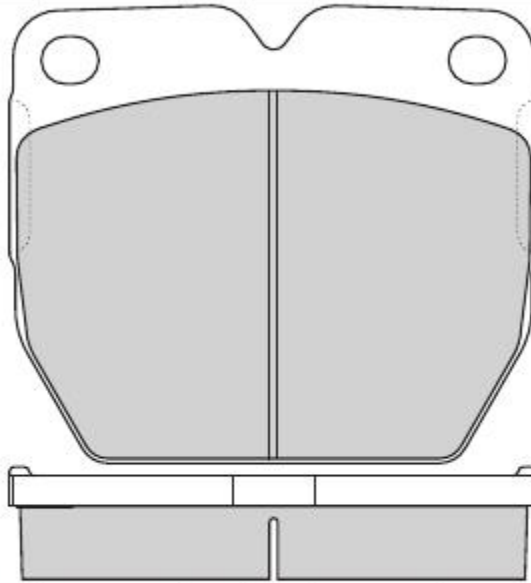

5312	IVECO	BREMBO	X	179,6	106	20	3A-3B 1C-1D	2	650
-------------	-------	--------	---	-------	-----	----	----------------	---	-----

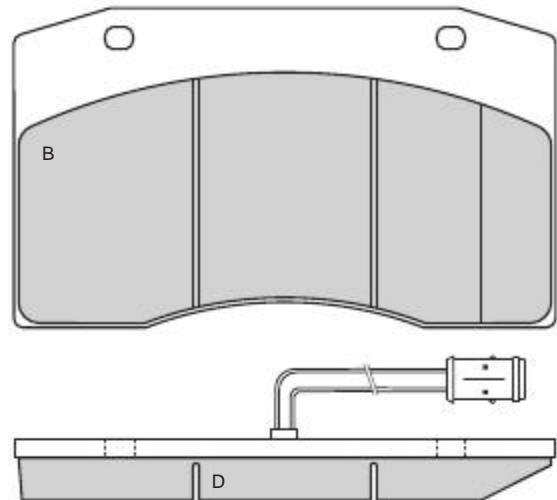
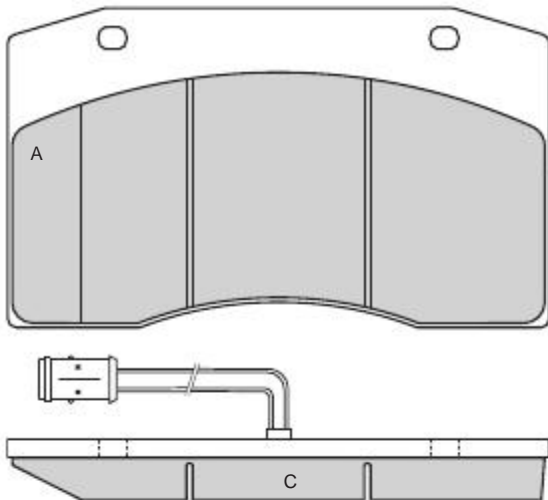







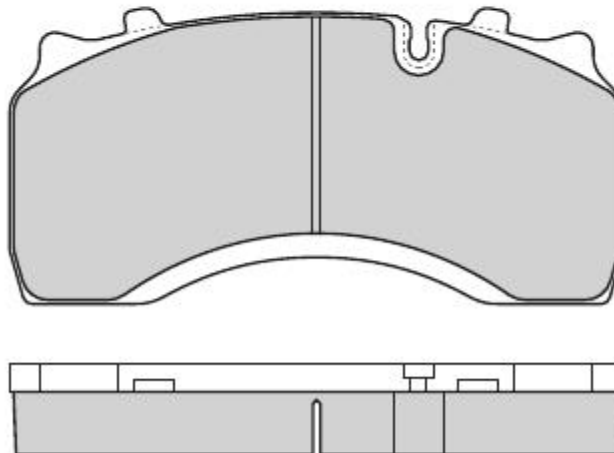

5313	DAF - RENAULT	WABCO	X	204,1	96,8	29,9	4	2	360
-------------	---------------	-------	---	-------	------	------	---	---	-----



OPTIONAL

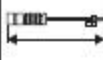

									
5314	BPW - KNORR	KNORR		247,5	109,5	30	4		

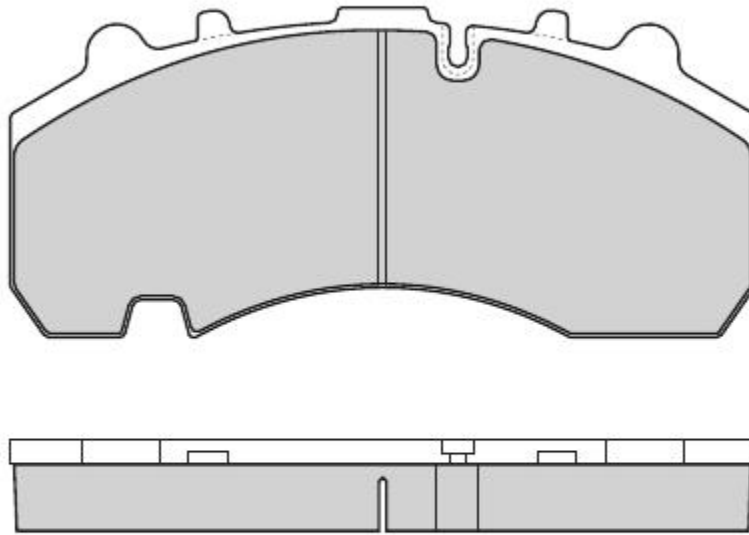



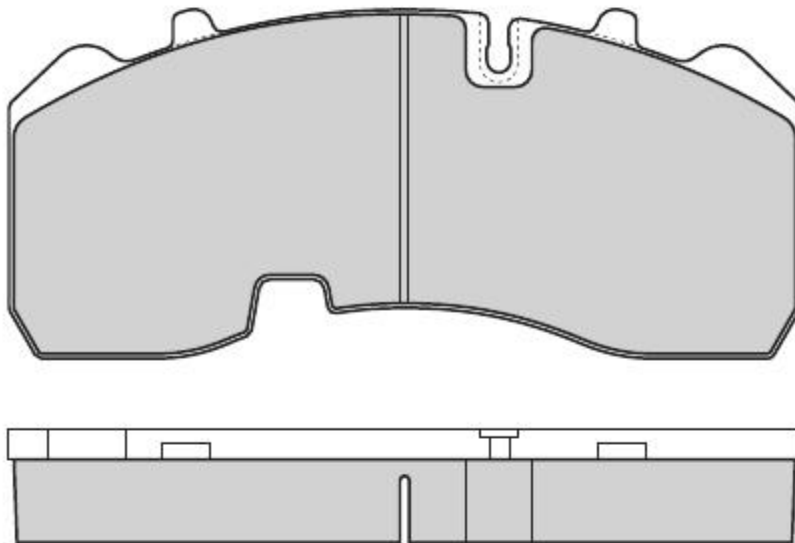



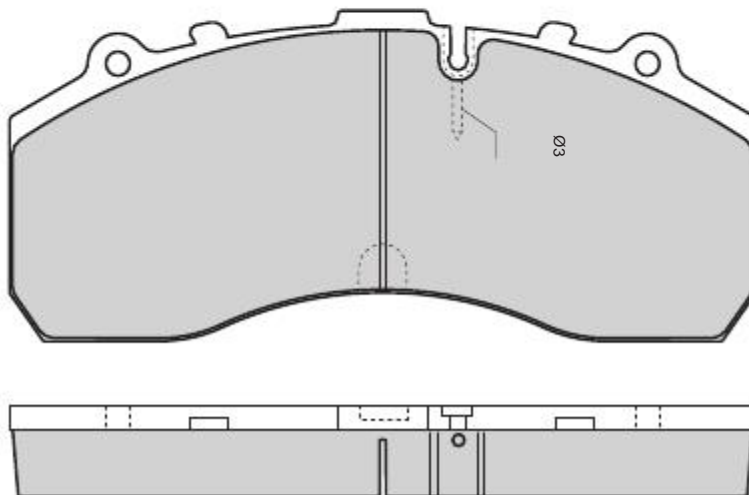



5315	BPW - KNORR	KNORR	X	210	92,5	30	4		
-------------	-------------	-------	---	-----	------	----	---	--	--



5316	DAF - MERCEDES - SCANIA	KNORR	X	247,6	109,5	30	4		
-------------	-------------------------	-------	---	-------	-------	----	---	--	--



									
5317	VOLVO	LUCAS		249	110,9	29,5	4		

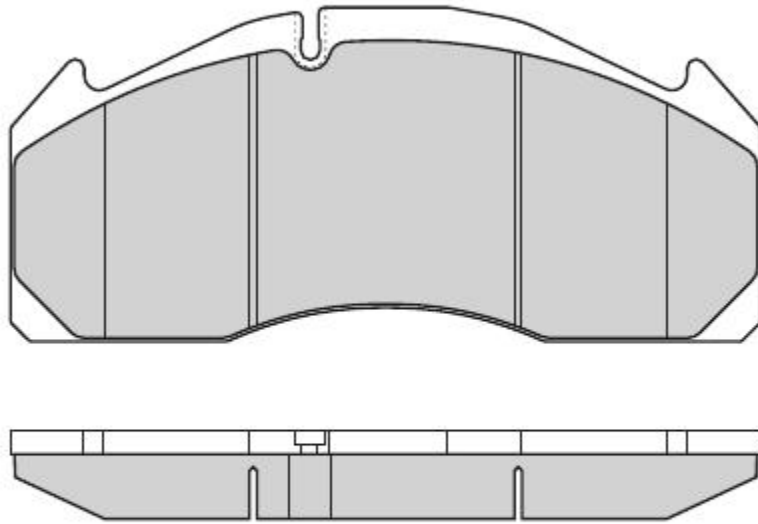



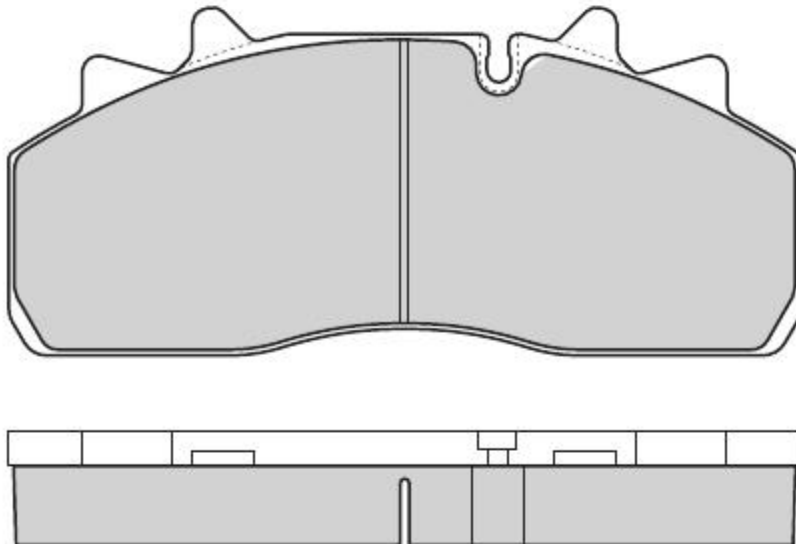



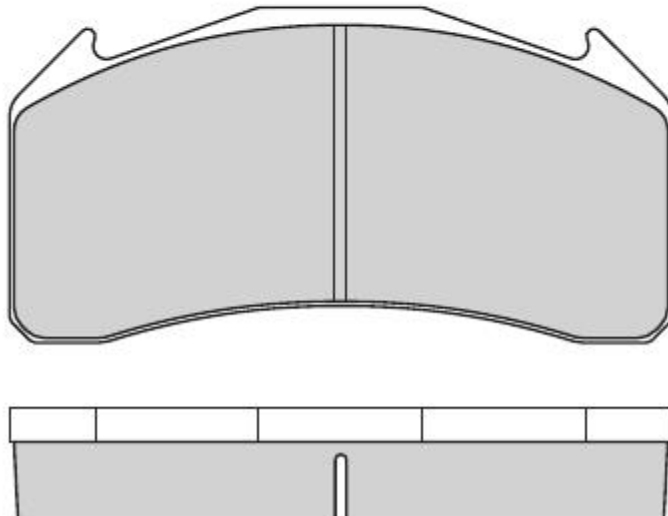



5318	DAF	WABCO	X	X	210,2	85,2	30	4	
-------------	-----	-------	---	---	-------	------	----	---	--



5319	MERITOR - VOLVO	LUCAS	X	X	175,2	88,5	29,3	4	
-------------	-----------------	-------	---	---	-------	------	------	---	--



									
5320	MERITOR - VOLVO	LUCAS	X	209,8	101,8	29,3	4		

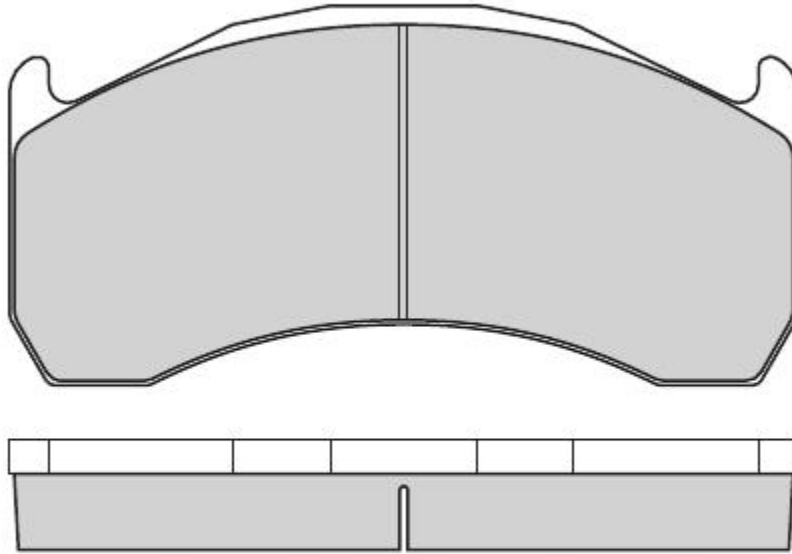



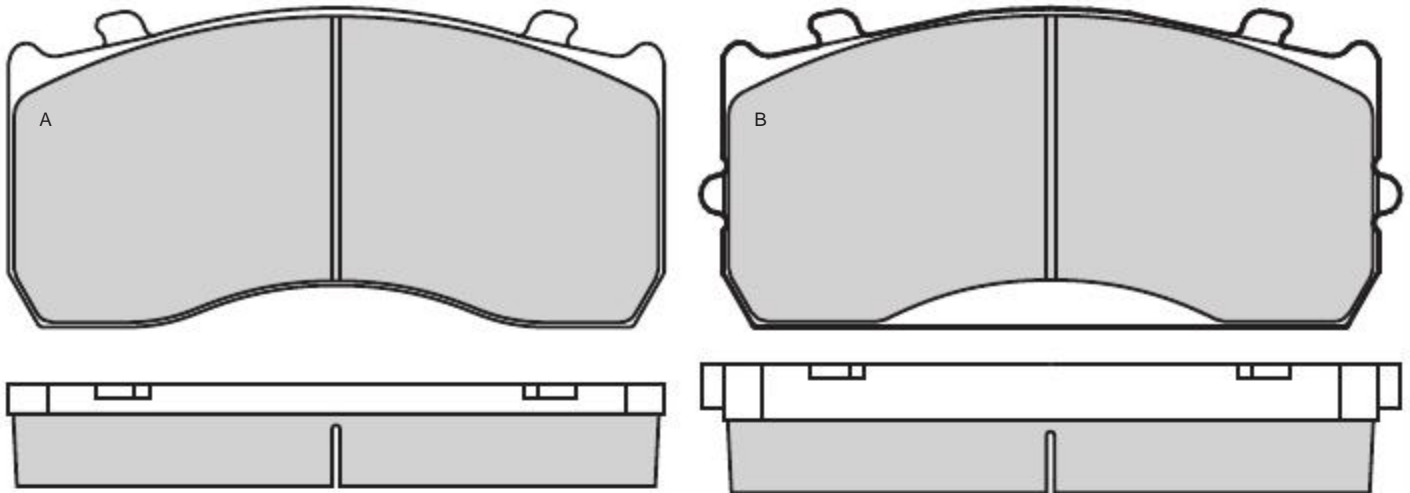



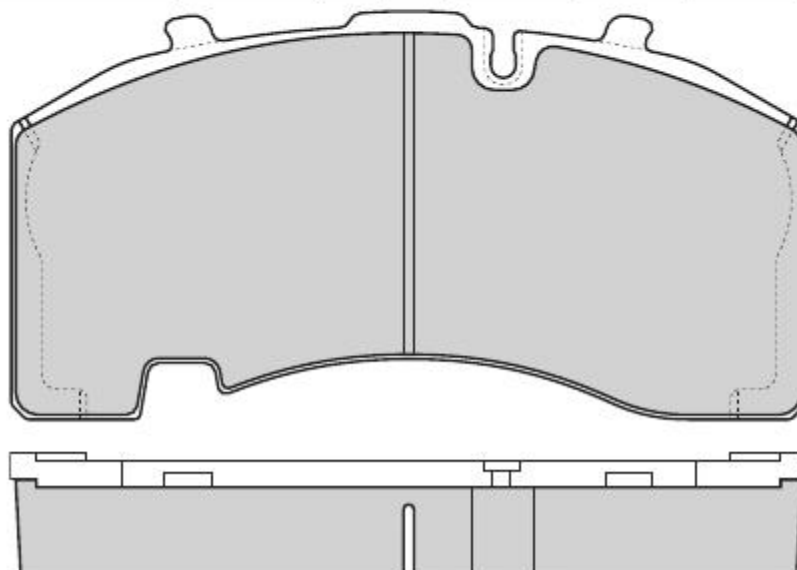

5321	MERCEDES	KNORR	X	X	A 173,5 B 185	84	A 27 B 34	2A-2B	
-------------	----------	-------	---	---	------------------	----	--------------	-------	--



5322	BPW	KNORR	X	X	210,1	107,8	30	4	
-------------	-----	-------	---	---	-------	-------	----	---	--

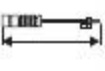

									
5323	RENAULT	MERITOR	X	210,1	99,5	30	4		

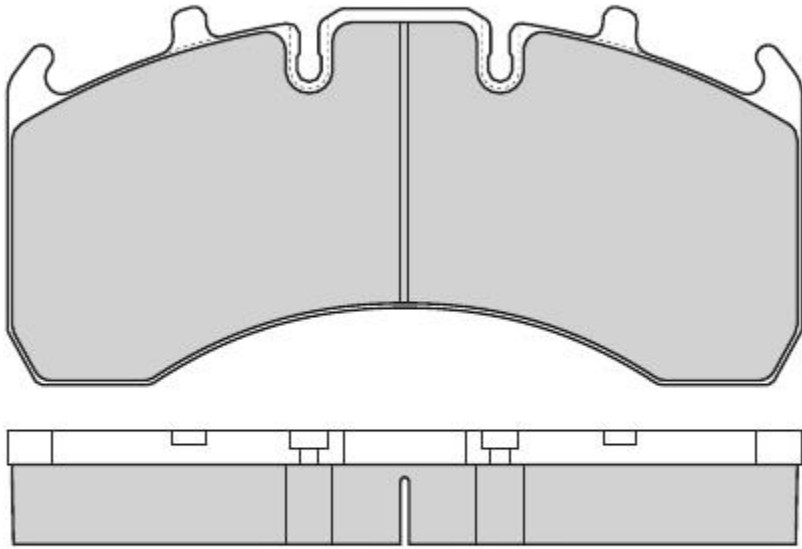



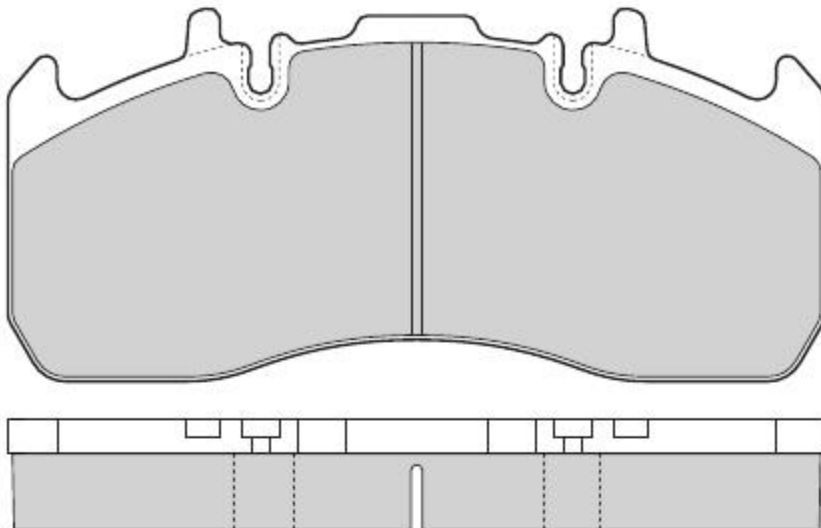



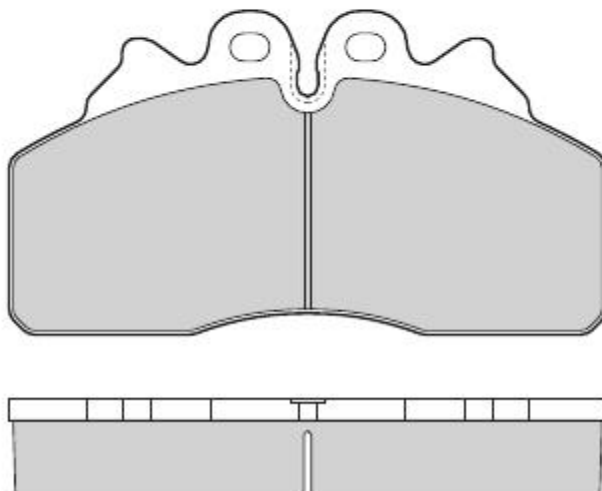

5324	RENAULT - VOLVO	MERITOR	X	216	99,5	29	4		
-------------	-----------------	---------	---	-----	------	----	---	--	--



5325	IVECO	BREMBO		175,4	94,9	27,5	4		
-------------	-------	--------	--	-------	------	------	---	--	--

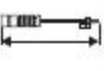

									
5326	RENAULT	MERITOR	X	249,5	109,7	29,3	4		

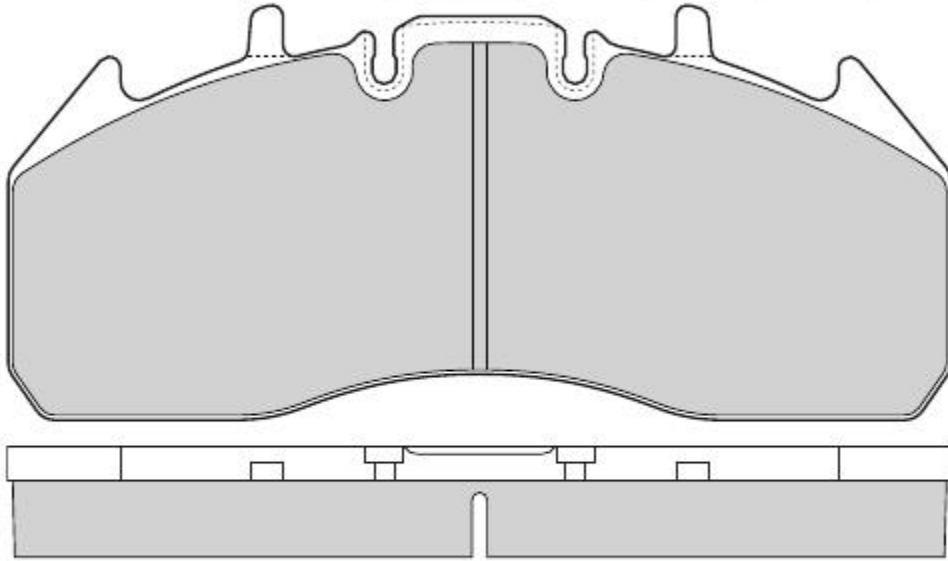



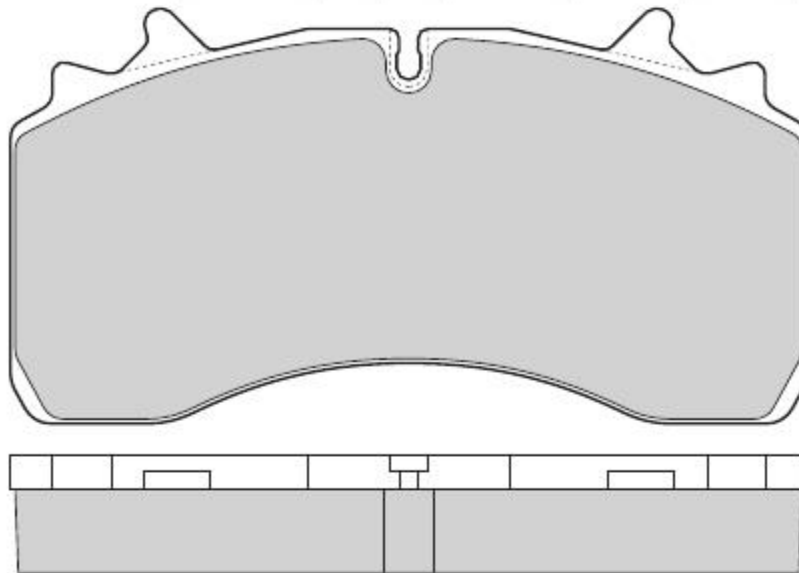



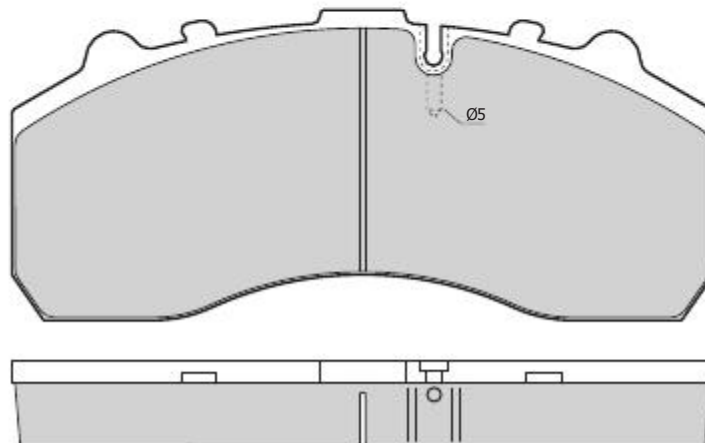

5327	SAF	WABCO	X	210,5	109,6	31	4		
-------------	-----	-------	---	-------	-------	----	---	--	--



5328	BOVA - BPW- IVECO MERCEDES - SCANIA	KNORR	X	247,6	109,5	30	4		
-------------	--	-------	---	-------	-------	----	---	--	--



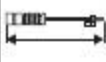

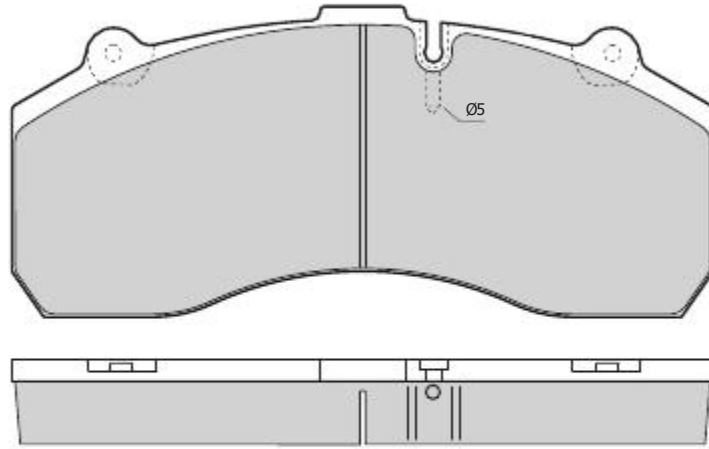



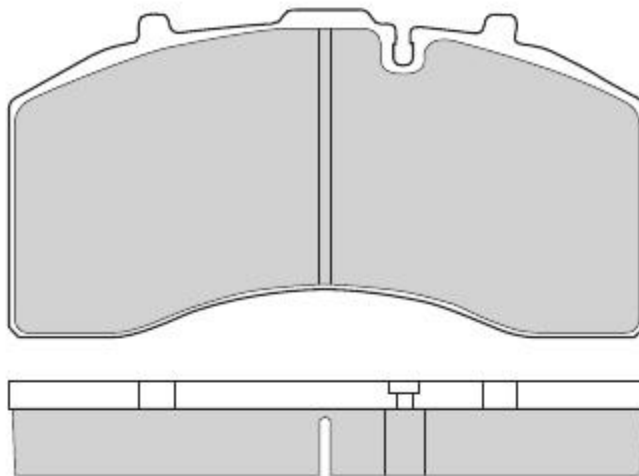



									
5329	DAF	KNORR	X	247,6	109,5	30	4		



5330	SAF	KNORR	X	210,7	107,1	30	4		
-------------	-----	-------	---	-------	-------	----	---	--	--



									
5332	MERCEDES	KNORR	X	207,6	113,7	30	4		

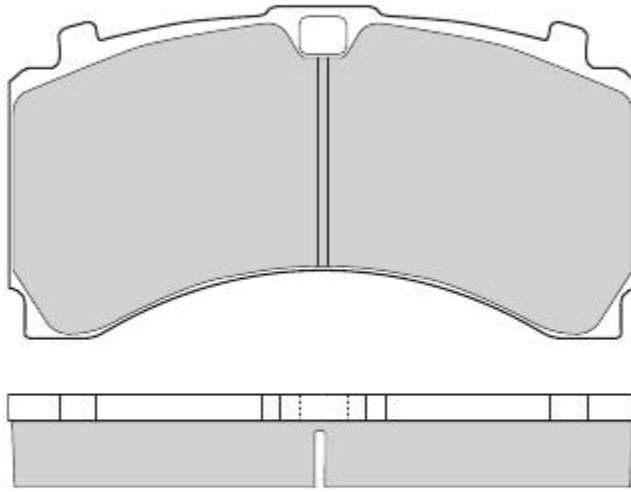



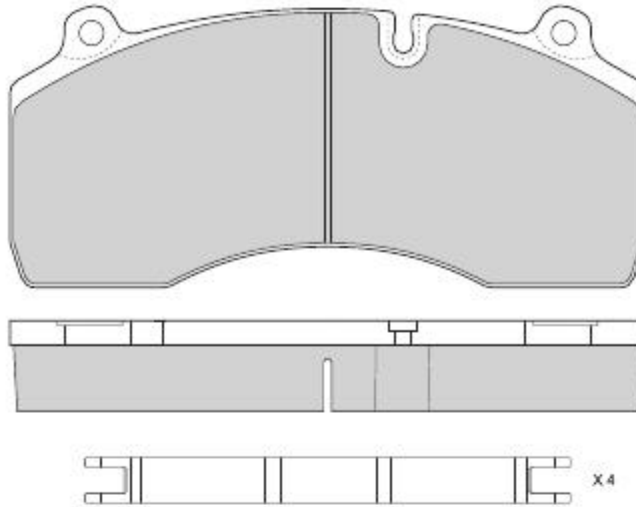



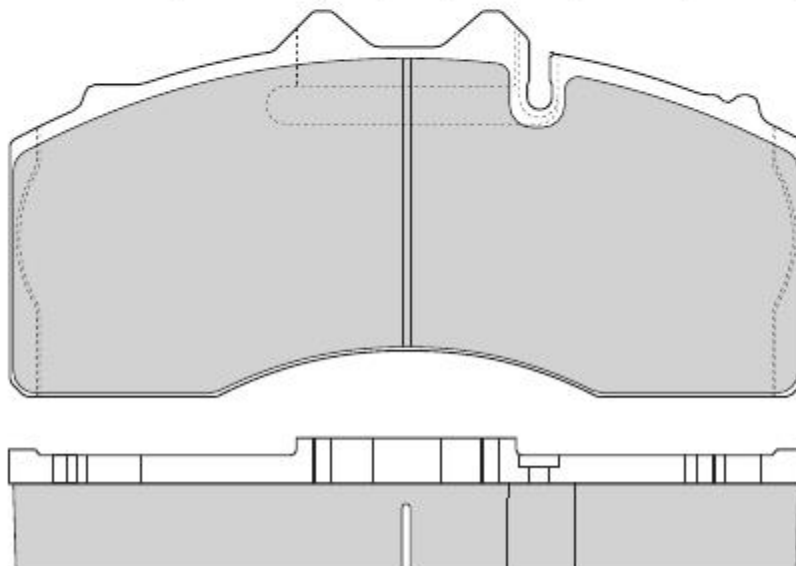

5333	RENAULT - VOLVO	HALDEX	X	X	210	93	30	4		
-------------	-----------------	--------	---	---	-----	----	----	---	--	--



5334	BPW	BPW	X	X	210	101,8	30	4		
-------------	-----	-----	---	---	-----	-------	----	---	--	--

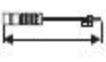

									
5335	MERCEDES	KNORR	X	244,6	113,7	30	4		

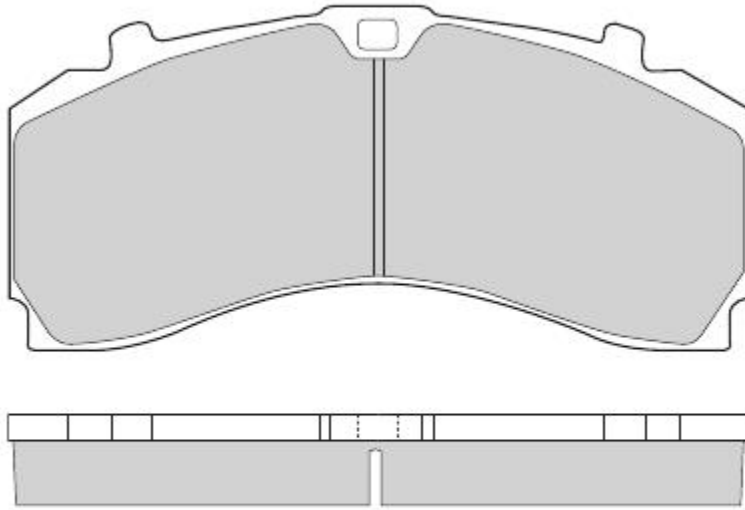



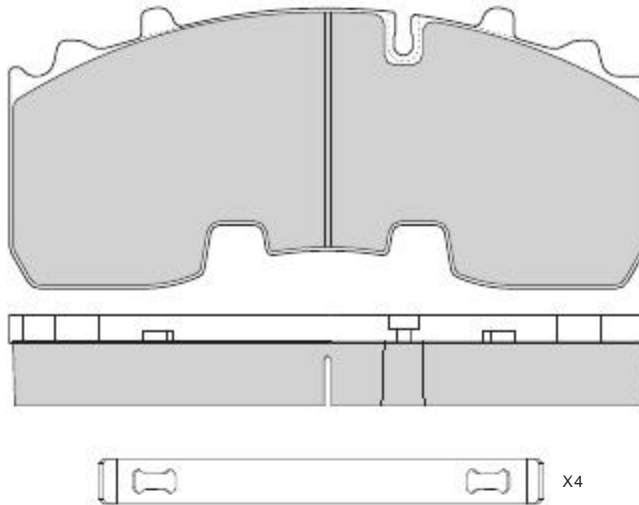



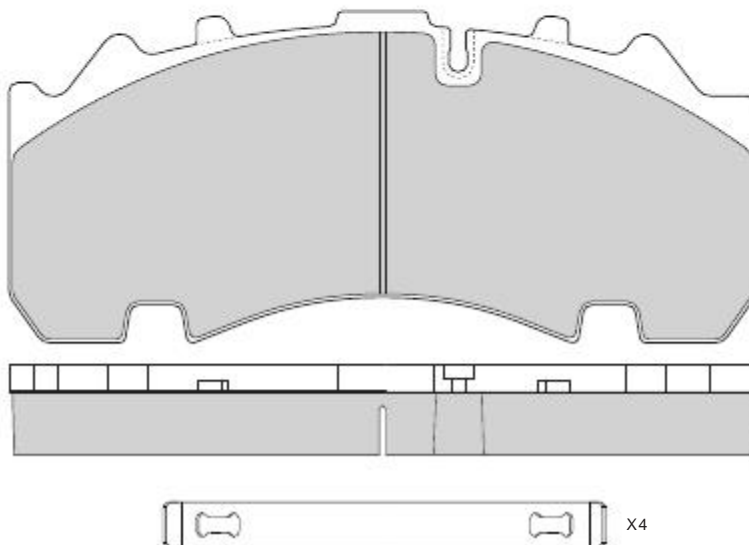



5336	BPW	KNORR	X	210,2	92,8	30	4		
-------------	-----	-------	---	-------	------	----	---	--	--



5337	BPW	KNORR	X	247,3	109,5	30	4		
-------------	-----	-------	---	-------	-------	----	---	--	--



									
5338	BPW	KNORR	X	210,5	108	30	4		

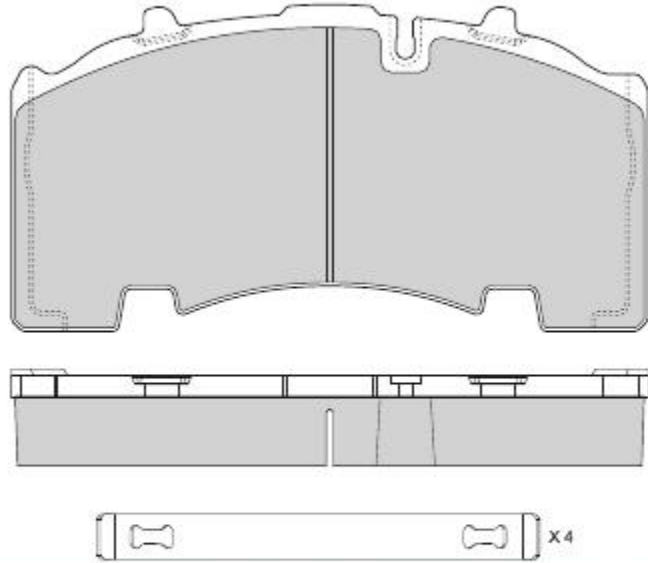

5339	BOVA - DAF - IVECO	KNORR	X	X	247,2	107,5	30	4	
-------------	--------------------	-------	---	---	-------	-------	----	---	--

